

EWEC.013			t 0,4
	EWEC.6C15AL.013		

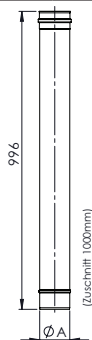

Längenelement 1000 mm

Ø A	80	100							
B									
C									
D									
E									
kg	0,82	1,01							
Ø A									
B									
C									
D									
E									
kg									

EWEC.014			t 0,4
	EWEC.6C15AL.014		

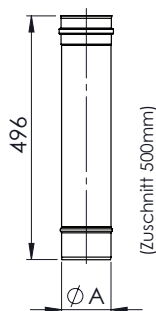

Längenelement 500 mm

Ø A	80	100							
B									
C									
D									
E									
kg	0,41	0,51							
Ø A									
B									
C									
D									
E									
kg									

EWEC.015			t 0,4
	EWEC.6C15.015		

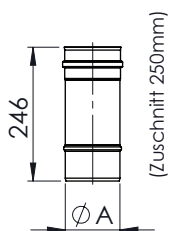

Längenelement 250 mm

Ø A	80	100							
B									
C									
D									
E									
kg	0,21	0,26							
Ø A									
B									
C									
D									
E									
kg									

EWEC.725			
	EWEC.6C15.725		

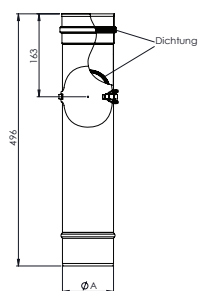

Längenelement 500 mm mit Revision

Ø A	80	100							
B									
C									
D									
E									
kg	0,44	0,54							
Ø A									
B									
C									
D									
E									
kg									

5.1 c) Pellets Verbindungsleitung Maße

EWEC.060				t 0,4
	EWEC.6C15AL.060			

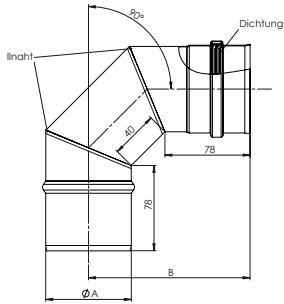

Winkel 90°



Ø A	80	100							
B	153	163							
C									
D									
E									
kg	0,23	0,3							
Ø A									
B									
C									
D									
E									
kg									

EWEC.673				t 0,4
	EWEC.6C15AL.673			

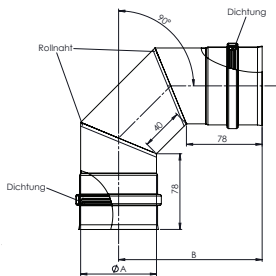

Winkel 90° mit Doppelmuffe



Ø A	80	100							
B	153	163							
C									
D									
E									
kg	0,24	0,31							
Ø A									
B									
C									
D									
E									
kg									

EWEC.019				t 0,4
	EWEC.6C15AL.019			

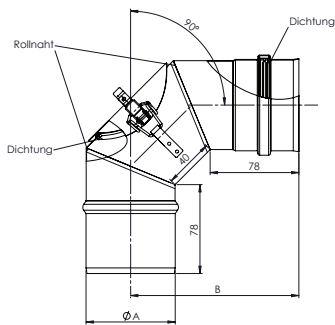

Winkel 90° mit Revision



Ø A	80	100							
B	153	163							
C									
D									
E									
kg	0,26	0,33							
Ø A									
B									
C									
D									
E									
kg									

EWEC.016				t 0,4
	EWEC.6C15AL.016			

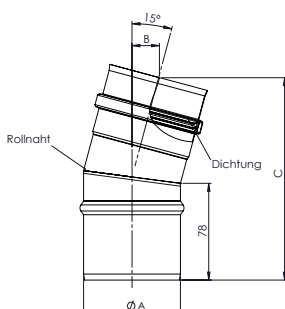

Winkel 15°



Ø A	80	100							
B	22	171							
C	23	173							
D									
E									
kg	0,15	0,19							
Ø A									
B									
C									
D									
E									
kg									

EWEC.017

t 0,4

EWEC.6C15AL.017

Winkel 30°

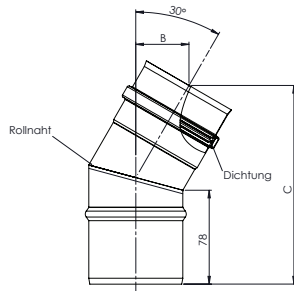

Ø A	80	100							
B	46	172							
C	47	177							
D									
E									
kg	0,17	0,21							
Ø A									
B									
C									
D									
E									
kg									

EWEC.018

t 0,4

EWEC.6C15AL.018

Winkel 45°

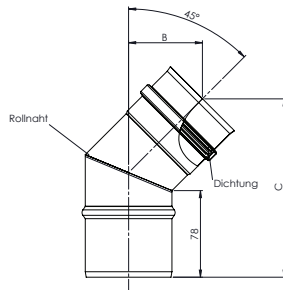

Ø A	80	100							
B	69	168							
C	72	175							
D									
E									
kg	0,17	0,21							
Ø A									
B									
C									
D									
E									
kg									

EWEC.557

EWEC.6C15AL.557

T-Anschluss 90° mit abnehmbarer Kondensatschale

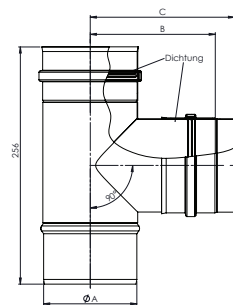

Ø A	80	100							
B	126	135							
C									
D									
E									
kg	0,49	0,73							
Ø A									
B									
C									
D									
E									
kg									

EWEC.674

t 0,4

EWEC674.6C15AL.674

Kesselanschluss mit Doppelmuffe inkl. Messstutzen

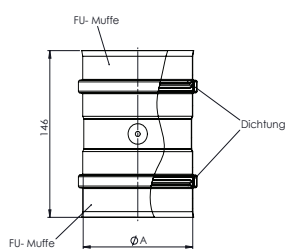

Ø A	80	100							
B									
C									
D									
E									
kg	0,14	0,17							
Ø A									
B									
C									
D									
E									
kg									

