

MA Remote Controller

[PAR-33MAA]

I .	Product Features	D-2
II .	Safety precautions	D-4
III .	Names and functions of controller components	D-5
IV .	Read before operating the controller	D-7
	1. Menu structure	D-7
	2. Main menu list	D-8
	3. Remote controller function	D-9
	4. Icon explanations	D-10
	5. Restrictions for the sub remote controller	D-10
V .	Controller operation - Basic operations	D-11
	1. Power ON / OFF	D-11
	2. Operation mode, temperature, and fan speed settings	D-12
	3. Navigating through the Main menu	D-15
	4. Vane · Louver · Vent. (Lossnay)	D-17
	5. Timer	D-19
	5.1. ON / OFF timer	D-19
	5.2. Auto-OFF timer	D-21
	6. Filter information	D-23
	7. Error information	D-25
	8. High power	D-26
VI .	Controller operation - Function settings	D-27
	1. Weekly timer	D-27
	2. OU silent mode	D-29
	3. Energy saving	D-31
	3.1. Automatic return to the preset temperature	D-31
	3.2. Setting the energy-saving operation schedule	D-33
	4. Night setback	D-35
	5. Restriction	D-37
	5.1. Setting the temperature range restriction	D-37
	5.2. Operation lock function	D-39
VII .	Maintenance	D-40
	1. Auto descending panel	D-40
	2. Manual vane angle	D-41
	3. 3D i-see Sensor setting	D-43
	3.1. 3D i-see Sensor setting	D-43
	3.2. Air distribution	D-44
	3.3. Energy saving option	D-46
	3.4. Seasonal airflow function	D-48
VIII .	Initial setting	D-49
	1. Main / Sub	D-49
	2. Clock	D-50
	3. Main display	D-51
	4. Contrast	D-52
	5. Display detail setting	D-53
	5.1. Clock	D-53
	5.2. Temperature Unit, Room temp, Auto mode	D-54
	6. Auto mode setting	D-55
	7. Administrator password setting	D-56
	8. Language selection	D-57
	9. Daylight saving time	D-58
IX .	Service	D-60
	1. Service menu	D-60
	2. Test run	D-61
	3. Drain pump test run	D-62
	4. Input maintenance Info.	D-63
	5. Function Setting	D-67
	5.1. Mr.Slim	D-67
	5.2. City Multi	D-69
	6. LOSSNAY setting (City Multi)	D-70
	7. Check	D-72
	7.1. Error history	D-72
	7.2. Refrigerant leak check	D-73
	7.3. Smooth maintenance	D-74
	7.4. Request code	D-75
	8. Self check	D-77
	9. Maintenance password	D-78
	10. Remote controller check	D-79
X .	Specifications · Outline Dimensions	D-80
	1. Specifications	D-80
	2. Outline Dimensions	D-80

I . Product Features

Ideal remote controller in pursuit of easy operation, convenience, and energy saving.

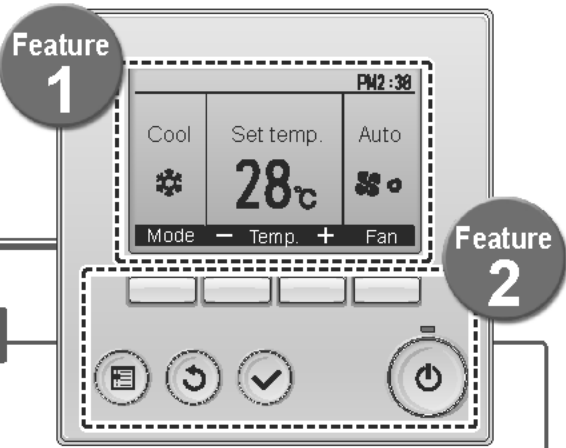

EASY OPERATION

Backlit LCD (Liquid Crystal Display)

Full dot backlit LCD makes it easy to see and control units.

- Feature 1** **Large, easy-to-see display**
Full-dot LCD display with large characters for easy viewing Contrast also adjustable.
- Feature 2** **Simple button arrangement**
Buttons are arranged according to usage to allow for intuitive navigation. Frequently used buttons are larger than other buttons to prevent unintended.

CONVENIENCE

Night Setback

To prevent indoor dew or excessive temperature rise, this control starts heating operation when the control object group is stopped and the room temperature drops below the preset lower limit temperature. Also, this control starts cooling operation when the control object group is stopped and the room temperature rises above the preset upper limit temperature.

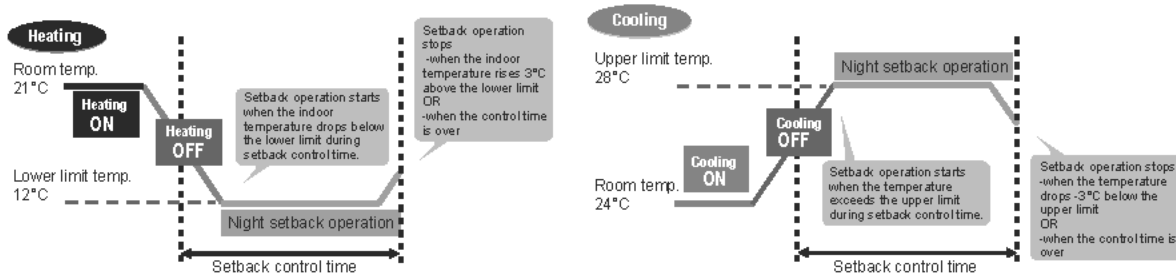

ENERGY SAVING

Auto Return

This function helps to maintain the indoor temperature at the required level. Even if the temperature setting is changed during operation, the set temperature automatically returns to the originally preset temperature after certain amount of time. It is possible to set the required temperature for limited time (30-120 min. in 10-minute increments).

<Sample screens when the Auto return function is enabled>

Example: Lower the Set temp. to 24°C. 60 minutes later, the Set temp. will be back to 28°C.

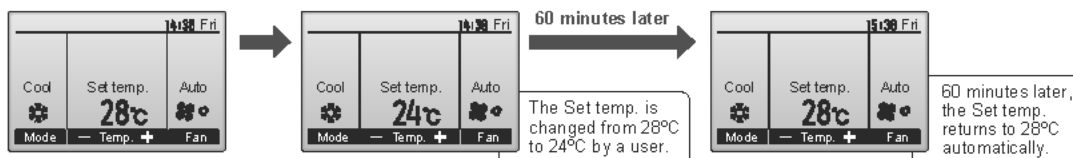

1. PRODUCT FEATURES (PAR-33MAA)

MA REMOTE CONTROLLER

Functions

Basic Functions

- ON/OFF - Operation mode switching - Room temperature setting/display - Fan speed setting
- Vane setting - Louver setting - Clock setting/display - Filter information display

Advanced Functions

Display mode switching	The main display can be displayed in two different modes: "Full" and "Basic".
Error information	Error code, error unit, unit address, unit model, serial number, contact information (dealer's phone number) can be displayed. * The unit model, serial number, and contact information need to be registered in advance to be displayed. * The unit address may not be displayed depending on the error type.
Ventilation equipment control	Interlock settings and interlock operation settings for Lossnay units can be made. OFF/High/Low can be switched.
High power	The units operate at higher-than-normal capacity for up to 30 minutes.
Auto descending panel	The automatic descending panel can be operated. * Valid only for the indoor units that are compatible with this function.
Timer	On/Off timer: The unit automatically turns on or off at the preset time. • Time can be set in 5-minute increments. • It is possible to set only the time when the unit turns on or when the unit turns off. Auto-Off timer: The unit automatically stops after the preset time has elapsed. • Time can be set to a value from 30 to 240 in 10-minute increments.
Weekly timer	ON/OFF and temperature setting can be scheduled for each day. • Up to eight operation patterns can be set for each day. • Time can be set in 5-minute increments. * Not valid when the On/Off timer is enabled.
Energy saving	The start/stop times to operate the units in the energy-save mode for each day of the week, and the energy-saving rate can be set. • Up to four energy-save operation patterns can be set for each day. • Time can be set in 5-minute increments. • Energy-saving rate can be set to a value from 0% and 50 to 90% in 10% increments.
Operation lock	Settings including ON/OFF, Operation mode, Set temp. and Vane can be locked.
Temperature range restriction	The lower limit and the upper limit of the settable temperature in each operation mode can be limited.
Password	Administrator password (required for schedule setting) and Maintenance password (required for test run and function setting) can be set.
Language selection	Language to be displayed on the screen can be selected from eight languages: English, French, German, Spanish, Italian, Portuguese, Swedish, and Russian.
Contrast	Screen contrast can be adjusted.
Manual vane angle	The vane angle can be set to a fixed position. * Valid only for the indoor units that are compatible with this function.

I . Safety precautions

- Thoroughly read the following safety precautions before using the unit.
- Observe these precautions carefully to ensure safety.

⚠ WARNING	Indicates a risk of death or serious injury.
⚠ CAUTION	Indicates a risk of serious injury or structural damage.

- After reading this manual, pass it on to the end user to retain for future reference.
- Keep this manual for future reference and refer to it as necessary. This manual should be made available to those who repair or relocate the controller. Make sure that the manual is passed on to any future users.

General precautions

⚠ WARNING

Do not install the unit in a place where large amounts of oil, steam, organic solvents, or corrosive gases, such as sulfuric gas, are present or where acidic/alkaline solutions or sprays are used frequently. These substances can compromise the performance of the unit or cause certain components of the unit to corrode, which can result in electric shock, malfunctions, smoke, or fire.

To reduce the risk of injury or electric shock, before spraying a chemical around the controller, stop the operation and cover the controller.

To reduce the risk of shorting, current leakage, electric shock, malfunctions, smoke, or fire, do not wash the controller with water or any other liquid.

To reduce the risk of injury or electric shock, stop the operation and switch off the power supply before cleaning, maintaining, or inspecting the controller.

To reduce the risk of electric shock, malfunctions, smoke or fire, do not operate the switches/buttons or touch other electrical parts with wet hands.

If any abnormality (e.g., burning smell) is noticed, stop the operation, turn off the power switch, and consult your dealer. Continued use of the product may result in electric shock, malfunctions, or fire.

When disinfecting the unit using alcohol, ventilate the room adequately. The fumes of the alcohol around the unit may cause a fire or explosion when the unit is turned on.

Properly install all required covers to keep moisture and dust out of the controller. Dust accumulation and water can cause electric shock, smoke, or fire.

⚠ CAUTION

To reduce the risk of fire or explosion, do not place flammable materials or use flammable sprays around the controller.

To reduce the risk of environmental pollution, consult an authorized agency for proper disposal of remote controller.

To reduce the risk of damage to the controller, do not directly spray insecticide or other flammable sprays on the controller.

To reduce the risk of electric shock or malfunctions, do not touch the touch panel, switches, or buttons with a pointy or sharp object.

To reduce the risk of injury and electric shock, avoid contact with sharp edges of certain parts.

To reduce the risk of injury, wear protective gear when working on the controller.

To avoid injury from broken glass, do not apply excessive force on the glass parts.

Precautions for moving or repairing the controller

⚠ WARNING

The controller should be repaired or moved only by qualified personnel. Do not disassemble or modify the controller. Improper installation or repair may cause injury, electric shock, or fire.

⚠ CAUTION

To reduce the risk of shorting, electric shock, fire, or malfunction, do not touch the circuit board with tools or with your hands, and do not allow dust to accumulate on the circuit board.

Additional precautions

To avoid damage to the controller, use appropriate tools to install, inspect, or repair the controller.

To avoid discoloration, do not use benzene, thinner, or chemical rag to clean the controller. To clean the controller, wipe with a soft cloth soaked in water with mild detergent, wipe off the detergent with a wet cloth, and wipe off water with a dry cloth.

This controller is designed for exclusive use with the Building Management System by Mitsubishi Electric. The use of this controller for with other systems or for other purposes may cause malfunctions.

To avoid damage to the controller, provide protection against static electricity.

I . SAFETY PRECAUTIONS [PAR-33MAA]

MA REMOTE CONTROLLER

III. Names and functions of controller components

Display

The main display can be displayed in two different modes: "Full" and "Basic".

The factory setting is "Full". To switch to the "Basic" mode, change the setting on the Main display setting. (Refer to D-51)

<Full mode>

* All icons are displayed for explanation.

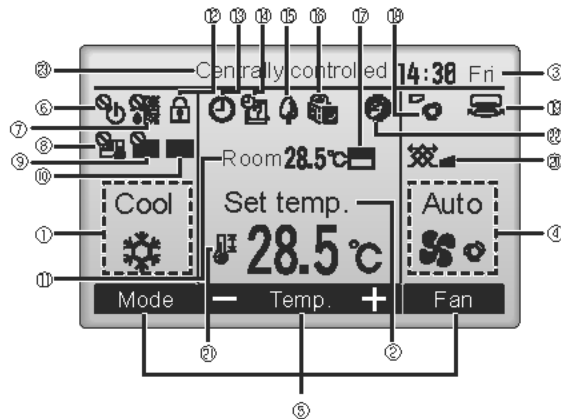

① Operation mode

Indoor unit operation mode appears here.

② Preset temperature

Preset temperature appears here.

③ Clock

(See the Installation Manual.)

Current time appears here.

④ Fan speed

Fan speed setting appears here.

⑤ Button function guide

Functions of the corresponding buttons appear here.



Appears when the ON/OFF operation is centrally controlled.



Appears when the operation mode is centrally controlled.



Appears when the preset temperature is centrally controlled.



Appears when the filter reset function is centrally controlled.



Indicates when filter needs maintenance.

⑪ Room temperature

(See the Installation Manual.)

Current room temperature appears here.



Appears when the buttons are locked.

Most settings (except ON/OFF, mode, fan speed, temperature) can be made from the Main menu. (Refer to D-15.)

<Basic mode>

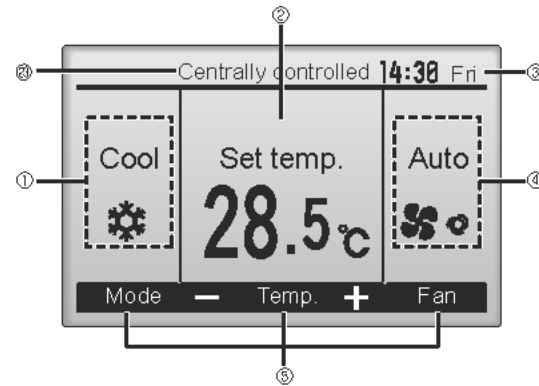

Appears when the On/Off timer (D-19), Night setback (D-35), or Auto-off timer (D-21) function is enabled.



Appears when the timer is disabled by the centralized control system.



Appears when the Weekly timer is enabled.



Appears while the units are operated in the energy-save mode. (Will not appear on some models of indoor units)



Appears while the outdoor units are operated in the silent mode.



Appears when the built-in thermistor on the remote controller is activated to monitor the room temperature (⑪).



Appears when the thermistor on the indoor unit is activated to monitor the room temperature.



Indicates the vane setting.



Indicates the louver setting.



Indicates the ventilation setting.



Appears when the preset temperature range is restricted.



Appears when an energy-saving operation is performed using a "3D i-See sensor" function.

⑫ Centrally controlled

Appears for a certain period of time when a centrally-controlled item is operated.

Controller interface

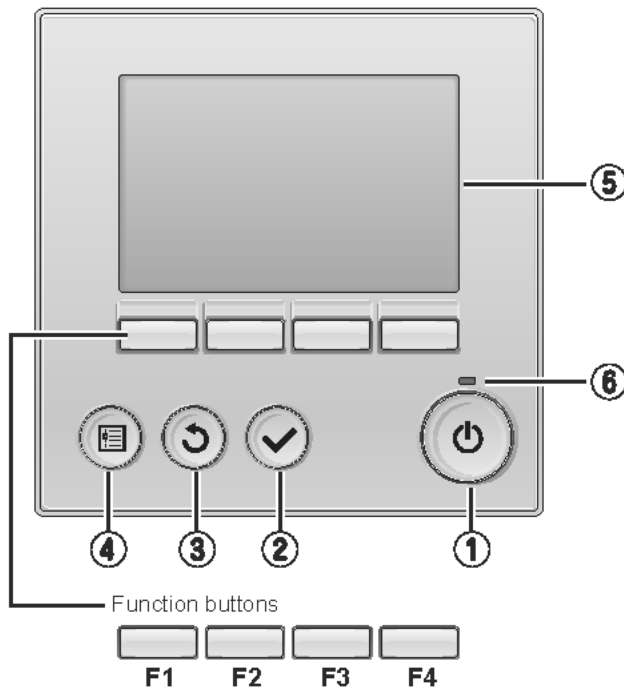

The functions of the function buttons change depending on the screen. Refer to the button function guide that appears at the bottom of the LCD for the functions they serve on a given screen.

When the system is centrally controlled, the button function guide that corresponds to the locked button will not appear.

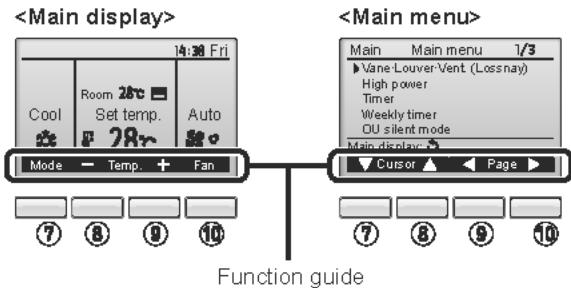

III. NAMES AND FUNCTIONS OF CONTROLLER COMPONENTS (PAR-33MAA)

MA REMOTE CONTROLLER

① ON / OFF button

Press to turn ON/OFF the indoor unit.

② SELECT button

Press to save the setting.

③ RETURN button

Press to return to the previous screen.

④ MENU button

Press to bring up the Main menu.

⑤ Backlit LCD

Operation settings will appear. When the backlight is off, pressing any button turns the backlight on and it will stay lit for a certain period of time depending on the screen.

When the backlight is off, pressing any button turns the backlight on and does not perform its function. (except for the ① (ON / OFF) button)

⑥ ON / OFF lamp

This lamp lights up in green while the unit is in operation. It blinks while the remote controller is starting up or when there is an error.

⑦ Function button F1

Main display : Press to change the operation mode.
Main menu : Press to move the cursor down.

⑧ Function button F2

Main display : Press to decrease temperature.
Main menu : Press to move the cursor up.

⑨ Function button F3

Main display : Press to increase temperature.
Main menu : Press to go to the previous page.

⑩ Function button F4

Main display : Press to change the fan speed.
Main menu : Press to go to the next page.

IV. Read before operating the controller

1. Menu structure

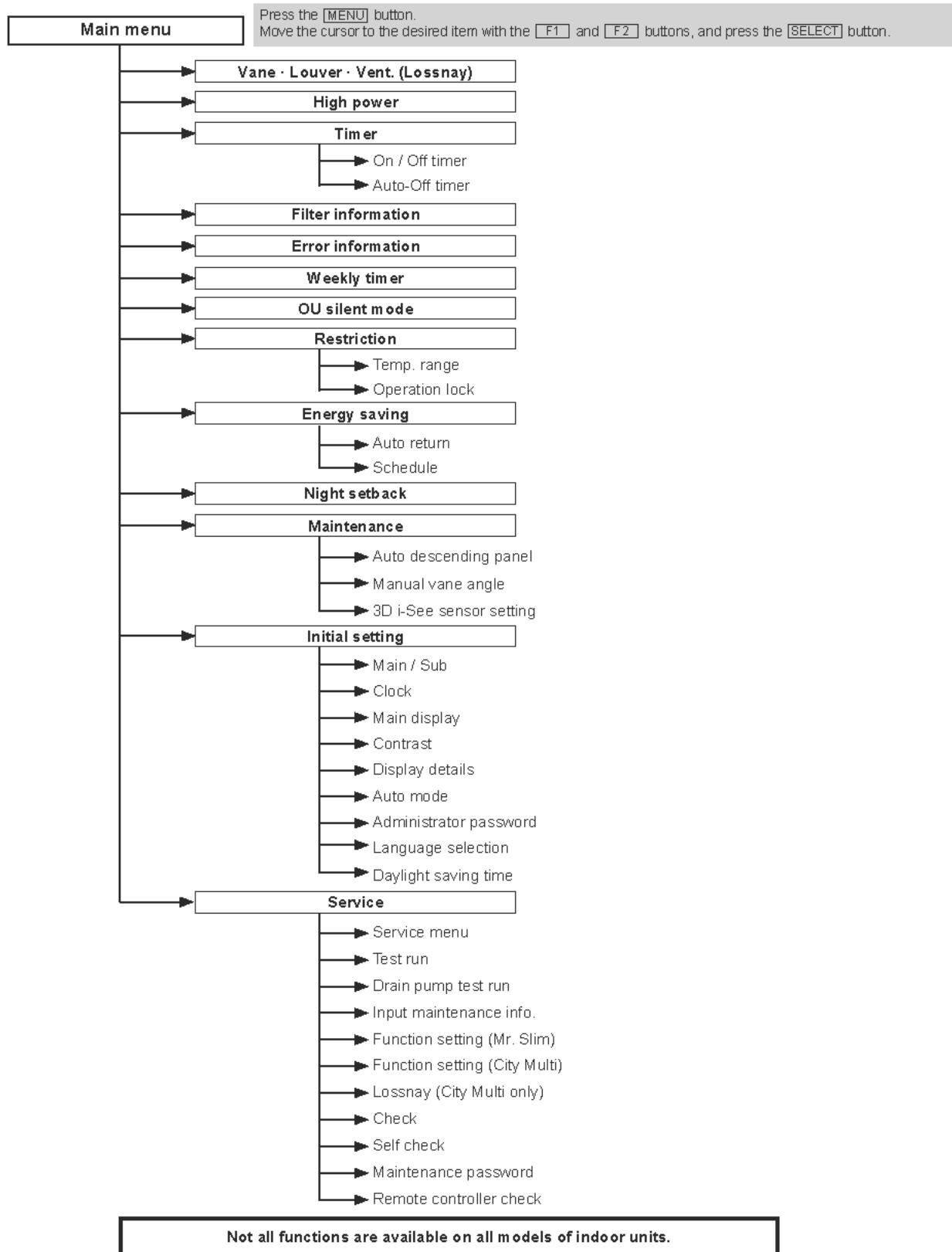

2. Main menu list

Setting and display items		Setting details
Vane · Louver · Vent. (Lossnay)		<p>Use to set the vane angle.</p> <ul style="list-style-type: none"> • Select a desired vane setting from five different settings. <p>Use to turn ON / OFF the louver.</p> <ul style="list-style-type: none"> • Select a desired setting from "ON" and "OFF." <p>Use to set the amount of ventilation.</p> <ul style="list-style-type: none"> • Select a desired setting from "Off," "Low," and "High."
High power		<p>Use to reach the comfortable room temperature quickly.</p> <ul style="list-style-type: none"> • Units can be operated in the High-power mode for up to 30 minutes.
Timer	On/Off timer	<p>Use to set the operation On/Off times.</p> <ul style="list-style-type: none"> • Time can be set in 5-minute increments. * Clock setting is required.
	Auto-Off timer	<p>Use to set the Auto-Off time.</p> <ul style="list-style-type: none"> • Time can be set to a value from 30 to 240 in 10-minute increments.
Filter information		<p>Use to check the filter status.</p> <ul style="list-style-type: none"> • The filter sign can be reset.
Error information		<p>Use to check error information when an error occurs.</p> <ul style="list-style-type: none"> • Error code, error source, refrigerant address, unit model, manufacturing number, contact information (dealer's phone number) can be displayed. * The unit model, manufacturing number, and contact information need to be registered in advance to be displayed.
Weekly timer		<p>Use to set the weekly operation On / Off times.</p> <ul style="list-style-type: none"> • Up to eight operation patterns can be set for each day. * Clock setting is required. * Not valid when the On/Off timer is enabled.
Energy saving	Auto return	<p>Use to get the units to operate at the preset temperature after performing energy-save operation for a specified time period.</p> <ul style="list-style-type: none"> • Time can be set to a value from 30 and 120 in 10-minute increments. * This function will not be valid when the preset temperature ranges are restricted. * 1°C increments
	Schedule	<p>Set the start/stop times to operate the units in the energy-save mode for each day of the week, and set the energy-saving rate.</p> <ul style="list-style-type: none"> • Up to four energy-save operation patterns can be set for each day. • Time can be set in 5-minute increments. • Energy-saving rate can be set to a value from 0% and 50 to 90% in 10% increments. * Clock setting is required.
OU silent mode		<p>Use to set the time periods in which priority is given to quiet operation of outdoor units over temperature control. Set the Start/Stop times for each day of the week.</p> <ul style="list-style-type: none"> • Select the desired silent level from "Normal," "Middle," and "Quiet." * Clock setting is required.
Night setback		<p>Use to make Night setback settings.</p> <ul style="list-style-type: none"> • Select "Yes" to enable the setting, and "No" to disable the setting. The temperature range and the start/stop times can be set. * Clock setting is required. * 1°C increments
Restriction	Temp. range	<p>Use to restrict the preset temperature range.</p> <ul style="list-style-type: none"> • Different temperature ranges can be set for different operation modes. * 1°C increments
	Operation lock	<p>Use to lock selected functions.</p> <ul style="list-style-type: none"> • The locked functions cannot be operated.
Maintenance	Auto descending panel	Auto descending panel (Optional parts) Up / Down you can do.
	Manual vane angle	Use to set the vane angle for each vane to a fixed position.
	3D i-See sensor setting	Appears with the units are operated in the energy-save mode with 3D i-see Sensor.
Initial setting	Main/Sub	When connecting two remote controllers, one of them needs to be designated as a sub controller.
	Clock	Use to set the current time.
	Main display	Use to switch between "Full" and "Basic" modes for the Main display. • The default setting is "Full."

Setting and display items		Setting details
Initial setting	Contrast	Use to adjust screen contrast.
	Display details	<p>Make the settings for the remote controller related items as necessary.</p> <p>Clock: The factory settings are "Yes" and "24h" format.</p> <p>Temperature: Set either Celsius (°C) or Fahrenheit (°F).</p> <p>Room temp. : Set Show or Hide.</p> <p>Auto mode: Set the Auto mode display or Only Auto display.</p>
	Auto mode	Whether or not to use the AUTO mode can be selected by using the button. This setting is valid only when indoor units with the AUTO mode function are connected.
	Administrator password	<p>The administrator password is required to make the settings for the following items.</p> <ul style="list-style-type: none"> • Timer setting • Energy-save setting • Weekly timer setting • Restriction setting • Outdoor unit silent mode setting • Night set back
	Language selection	Use to select the desired language.
Service	Test run	<p>Select "Test run" from the Service menu to bring up the Test run menu.</p> <ul style="list-style-type: none"> • Test run • Drain pump test run
	Input maintenance	<p>Select "Input maintenance Info." from the Service menu to bring up the Maintenance information screen.</p> <p>The following settings can be made from the Maintenance Information screen.</p> <ul style="list-style-type: none"> • Model name input • Serial No. input • Dealer information input
	Function setting(Mr.slim)	Make the settings for the indoor unit functions via the remote controller as necessary.
	Function setting (City Multi)	Use to make settings to for indoor unit's function.
	LOSSNAY setting (City Multi only)	This setting is required only when the operation of City Multi units is interlocked with LOSSNAY units.
	Check	<p>Error history: Display the error history and execute delete error history.</p> <p>Refrigerant leak check: Refrigerant leaks can be judged.</p> <p>Smooth maintenance: The indoor and outdoor maintenance data can be displayed.</p> <p>Request cord: Details of the operation data including each thermistor temperature and error history can be checked.</p>
	Self check	Error history of each unit can be checked via the remote controller.
	Maintenance password	Take the following steps to change the maintenance password.
Remote controller check	When the remote controller does not work properly, use the remote controller checking function to troubleshoot the problem.	

3. Remote controller function

* The functions which can be used are restricted according to the model.

○ : Supported ✕ : Unsupported

	Function	PAR-33MAA	
		Slim	City multi
Body	Product size H × W × D (mm)	120 × 120 × 19	
	LCD	Full Dot LCD	
	Backlight	○	
Energy-saving	Energy-saving operation schedule	○	✕
	Automatic return to the preset temperature	○	
Restriction	Setting the temperature range restriction	○	
Function	Operation lock function	○	
	Weekly timer	○	
	On / Off timer	○	
	High Power	○	✕
	Manual vane angle	○	
	Auto (dual set point) mode	✕	○

MA REMOTE CONTROLLER
IV. READ BEFORE OPERATING THE CONTROLLER [PAR-33MAA]

	Function	PAR-33MAA	
		Slim	City multi
Maintenance	Auto descending panel operation		○
	Clock		○
	Language selection		○
	Night setback		○
	Smooth maintenance	○	×
	Refrigerant leak check	○	×
Support	Contact information (Manual entry)		○
	Model name Serial No (Manual entry)		○

4. Icon explanations

Controller operation

Timer

The table below summarizes the square icons used in this manual.

	<p>The administrator password must be entered on the password input screen to change settings. There is no settings that can skip this process.</p> <div style="border: 1px solid gray; padding: 5px; width: fit-content; margin: 10px auto;"> <p style="text-align: center;">Timer</p> <p style="text-align: center;">Enter administrator password</p> <p style="text-align: center;">■■■■</p> <p>Select: ▾</p> <p style="text-align: center;">◀ Cursor ▶ - +</p> </div> <div style="display: flex; justify-content: center; gap: 10px; margin-top: 5px;"> <div style="border: 1px solid gray; padding: 2px 5px;">F1</div> <div style="border: 1px solid gray; padding: 2px 5px;">F2</div> <div style="border: 1px solid gray; padding: 2px 5px;">F3</div> <div style="border: 1px solid gray; padding: 2px 5px;">F4</div> </div> <p style="font-size: small; margin-top: 5px;">*Changes cannot be made unless the correct password is entered.</p>		<p>Indicates settings that can be made only from the main remote controller.</p>
	Indicates settings that can be changed only while the units are in operation.		Indicates settings that can be changed only while the units are not in operation.
	Indicates settings that can be changed only while the units are operated in the Cool, Heat, or Auto mode.		Indicates functions that are not available when the buttons are locked or the system is centrally controlled.

5. Restrictions for the sub remote controller

Main Main menu 1/3

- ▶ Vane-Louver-Vent. (Lossnay)
- High power
- Timer
- Weekly timer
- OU silent mode

Main display: ↻

▼ Cursor ▲ ◀ Page ▶

The following settings cannot be made from the sub remote controller. Make these settings from the main remote controller. "Main" is displayed in the title of the Main menu on the main remote controller.

- Timer (On / Off timer, Auto-Off timer)
- Weekly timer
- OU silent mode
- Energy saving (Auto return, Schedule)
- Night setback
- Maintenance (Manual vane angle)

READ BEFORE OPERATING THE CONTROLLER (PAR-33MAA)

MA REMOTE CONTROLLER

V. Controller operation - Basic operations

1. Power ON / OFF



Button operation

[ON]



Press the **[ON/OFF]** button.
The ON / OFF lamp will light up in green, and the operation will start.

[OFF]



Press the **[ON/OFF]** button again.
The ON / OFF lamp will come off, and the operation will stop.

Operation status memory

	Remote controller setting
Operation mode	Operation mode before the power was turned off
Preset temperature	Preset temperature before the power was turned off
Fan speed	Fan speed before the power was turned off

Settable preset temperature range

Operation mode	Preset temperature range
Cool/Dry	19 – 30 °C (67 – 87 °F)
Heat	17 – 28 °C (63 – 83 °F)
Auto(Single set point)	19 – 28 °C (67 – 83 °F)
Auto(Dual set point)	[Cool] Preset temperature range for the Cool mode [Heat] Preset temperature range for the Heat mode
Fan / Ventilation	Not settable

The settable temperature range varies with the model of indoor units.

2. Operation mode, temperature, and fan speed settings



Button operation

[Operation mode]

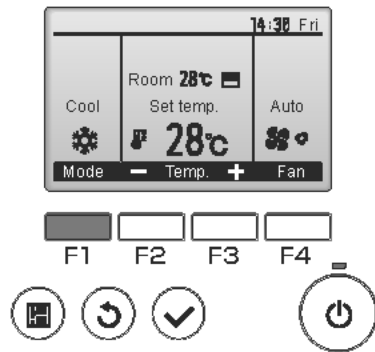

Press the **F1** button to go through the operation modes in the order of "Cool, Dry, Fan, Auto, and Heat." Select the desired operation mode.

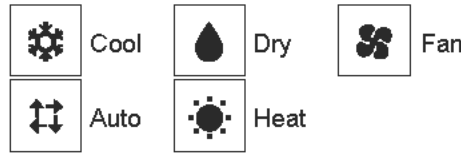

• Operation modes that are not available to the connected indoor unit models will not appear on the display.

<What the blinking mode icon means>

The mode icon will blink when other indoor units in the same refrigerant system (connected to the same outdoor unit) are already operated in a different mode. In this case, the rest of the unit in the same group can only be operated in the same mode.

<AUTO (dual set point) mode>

When the operation mode is set to the Auto (dual set point) mode, two preset temperatures (one each for cooling and heating) can be set. Depending on the room temperature, indoor unit will automatically operate in either the Cool or Heat mode and keep the room temperature within the preset range.

The graph below shows the operation pattern of indoor unit operated in the Auto (dual set point) mode.

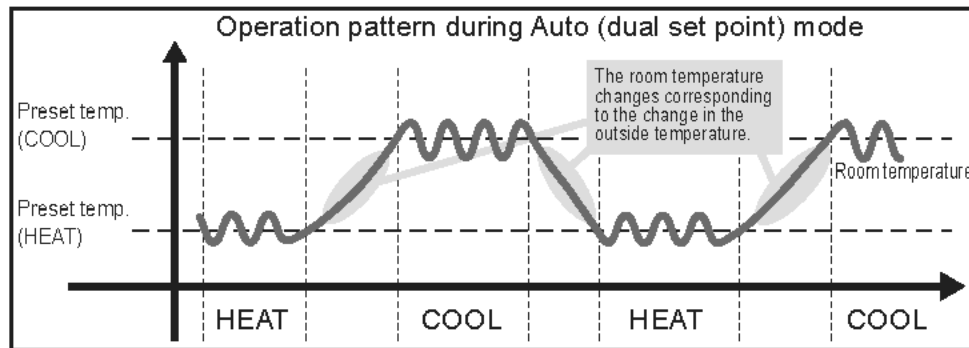

[Preset temperature]

<Cool, Dry, Heat, and Auto (single set point)>

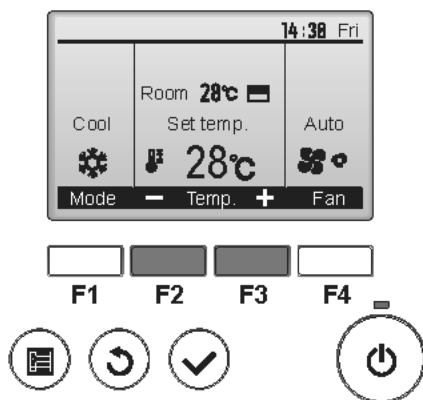

Press the **F2** button to decrease the preset temperature, and press the **F3** button to increase.

- Refer to the table on page D-11 for the settable temperature range for different operation modes.
- Preset temperature range cannot be set for Fan/Ventilation operation.
- Preset temperature will be displayed either in Centigrade in 0.5- or 1-degree increments, or in Fahrenheit, depending on the indoor unit model and the display mode setting on the remote controller.

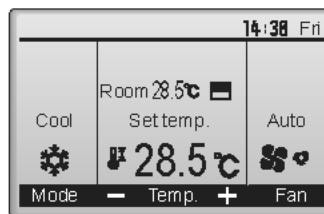

Example display
(Centigrade in 0.5-degree increments)

<Auto (dual set point) mode>

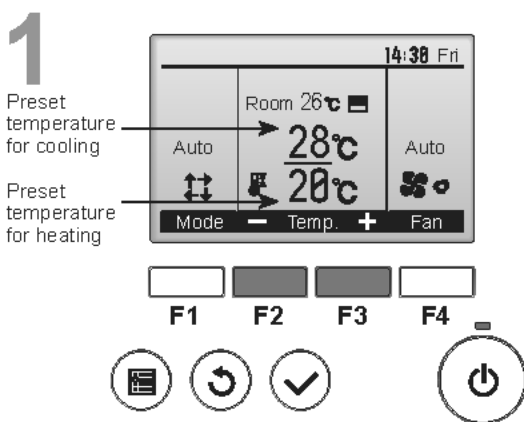

The current preset temperatures will appear. Press the **F2** or **F3** button to display the Settings screen.

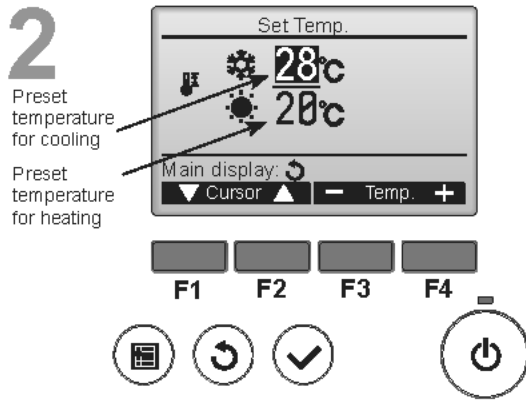

Press the **F1** or **F2** button to move the cursor to the desired temperature setting (cooling or heating).

Press the **F3** button to decrease the selected temperature, and **F4** to increase.

- Refer to the table on page D-11 for the settable temperature range for different operation modes.
- The preset temperature settings for cooling and heating in the Auto (dual set point) mode are also used by the Cool/Dry and Heat modes.
- The preset temperatures for cooling and heating in the Auto (dual set point) mode must meet the conditions below:
 - Preset cooling temperature is higher than preset heating temperature.
 - The minimum temperature difference requirement between cooling and heating preset temperatures (varies with the models of indoor units connected) is met.
 - * If preset temperatures are set in a way that does not meet the minimum temperature difference requirement, both preset temperatures will automatically be changed within the allowable setting ranges.

Navigating through the screens

- To return to the Main screen **RETURN** button

[Fan speed]

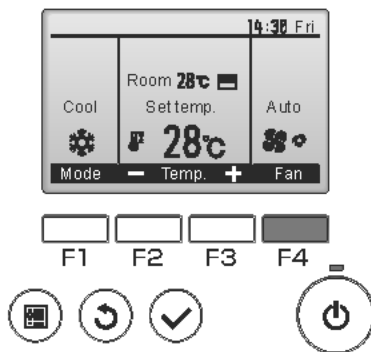

Press the **F4** button to go through the fan speeds in the following order.

- The available fan speeds depend on the models of connected indoor units.



3. Navigating through the Main menu

Button operation

[Accessing the Main menu]

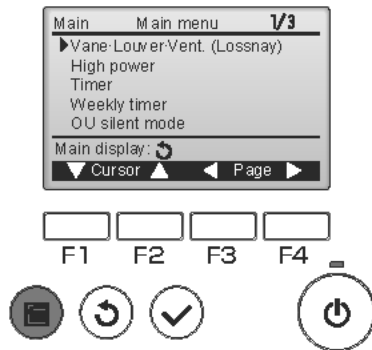

Press the  button.

The Main menu will appear.

[Item selection]

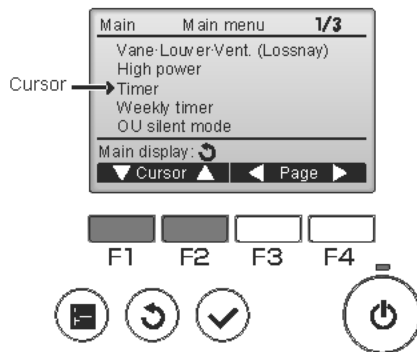

Press  to move the cursor down.

Press  to move the cursor up.

[Navigating through the pages]

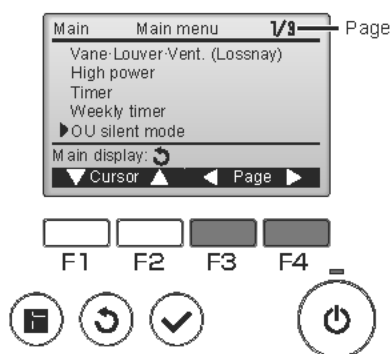

Press  to go to the previous page.

Press  to go to the next page.

[Saving the settings]

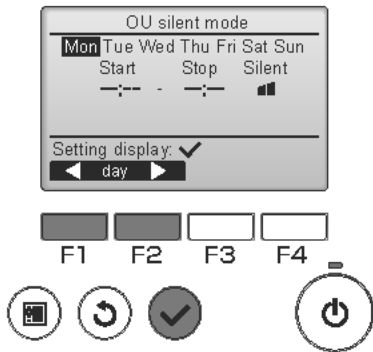

Select the desired item, and press the button.

The screen to set the selected item will appear.

[Exiting the Main menu screen]

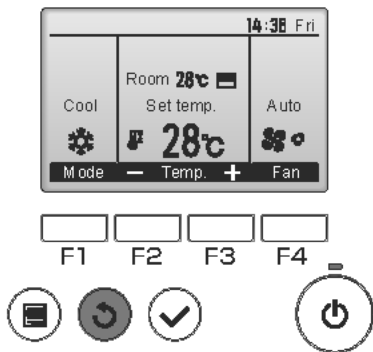

Press the button to exit the Main menu and return to the Main display.

If no buttons are touched for 10 minutes, the screen will automatically return to the Main display. Any settings that have not been saved will be lost.

[Display of unsupported functions]

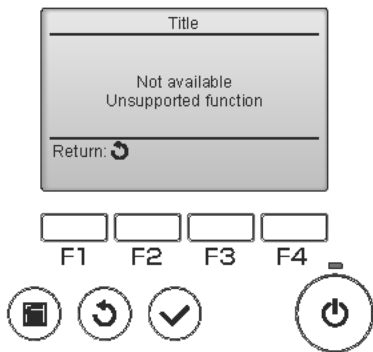

The message at left will appear if the user selects a function not supported by the corresponding indoor unit model.

4. Vane · Louver · Vent. (Lossnay)



Button operation

[Accessing the menu]

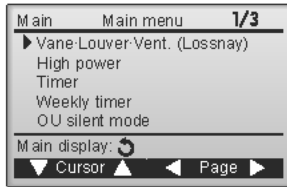

Select "Vane · Louver · Vent. (Lossnay)" from the Main menu (refer to D-15), and press the button.

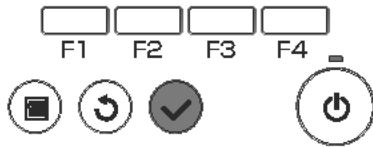

[Vane setting]

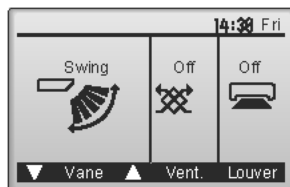

Press the **F1** or **F2** button to go through the vane setting options: "AUTO", "Step 1", "Step 2", "Step 3", "Step 4", "Step 5" and "Swing."

Select the desired setting.

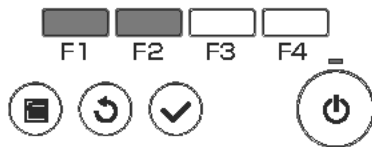

(Sample screen on City Multi)

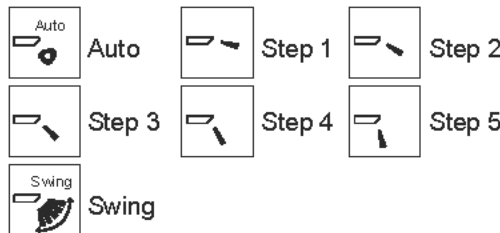

Select "Swing" to move the vanes up and down automatically. When set to "Step 1" through "Step 5", the vane will be fixed at the selected angle.

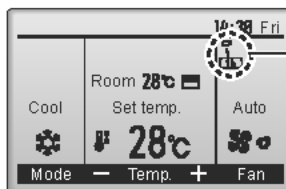

1h under the vane setting icon

This icon will appear when the vane is set to "Step 5" and the fan operates at low speed during cooling or dry operation (depends on the model). The icon will go off in an hour, and the vane setting will automatically change.

[Louver setting]

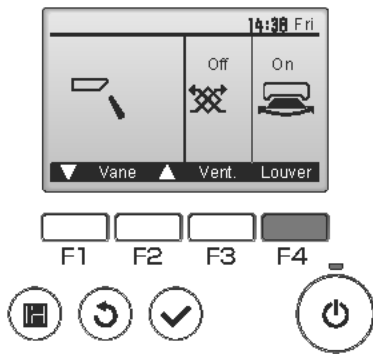

(Sample screen on City Multi)

Press the **[F4]** button to turn the louver swing ON and OFF.



[Vent. setting]

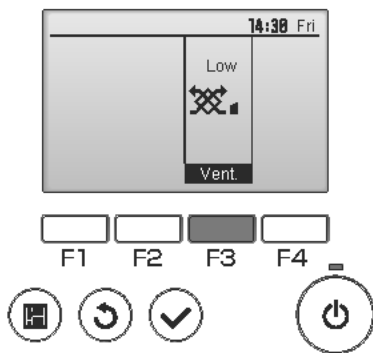

(Sample screen on Mr. Slim)

Press the **[F3]** button to go through the ventilation setting options in the order of "Off," "Low," and "High."

* Settable only when LOSSNAY unit is connected.

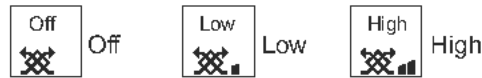

• The fan on some models of indoor units may be interlocked with certain models of ventilation units.

[Returning to the Main menu]

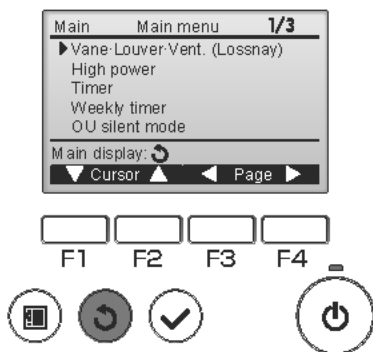

Press the **[F2]** button to go back to the Main menu.

5. Timer



5.1. ON / OFF timer

The unit automatically turns on or off at the preset time.

(ex. Operation start time PM 2:30/ Operation stop time AM 12:50/ only one)

Button operation

[1]

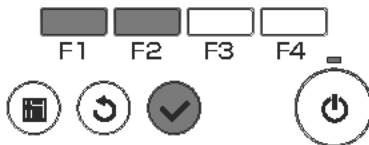
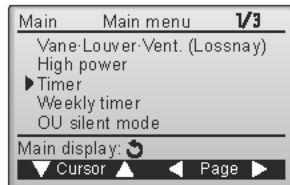

Select "Timer" from the Main menu (refer to D-15), and press the button.

The On/Off timer will not work in the following cases:

when On/Off timer is disabled, during an error, during check (in the service menu), during test run, during remote controller diagnosis, when the clock is not set, during Function setting, when the system is centrally controlled (when On/Off operation from local controller is prohibited).

[2]

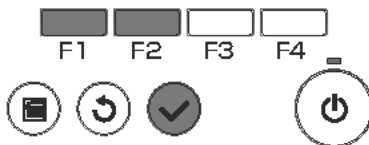
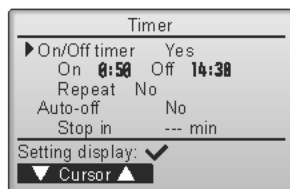

The current settings will appear.

Move the cursor to the On / Off timer, and press the button.

[3]

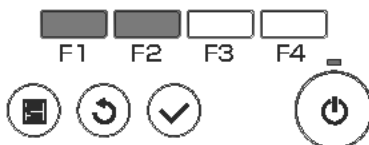
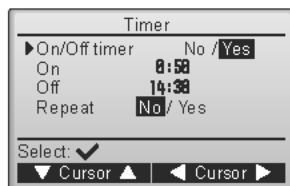

The screen to set the timer will appear.

Select the desired item with the **F1** or **F2** button out of "On / Off timer", "On", "Off" or "Repeat".

[4]

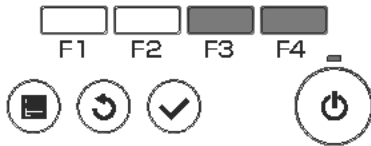
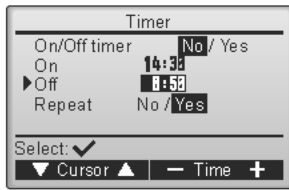

Change the setting with the [F3] or [F4] button.

- **On / Off timer:** No (disable) / Yes (enable)
- **On:** Operation start time (settable in 5-minute increments)
* Press and hold the button to rapidly advance the numbers.
- **Off:** Operation stop time (settable in 5-minute increments)
* Press and hold the button to rapidly advance the numbers.
- **Repeat:** No (once) / Yes (repeat)

[5]

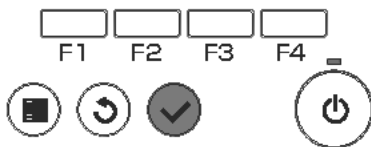
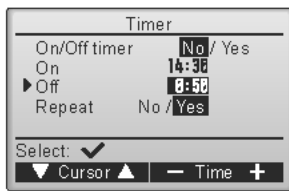

Press the [Checkmark] button to save the settings.

A confirmation screen will appear.

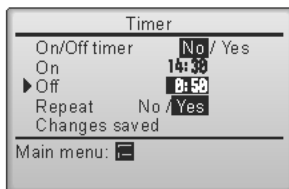

Navigating through the screens

- To go back to the Main menu [Square] button
- To return to the previous screen..... [Circular Arrow] button

V. CONTROLLER OPERATION-BASIC OPERATIONS (PAR-33M(A))

MA REMOTE CONTROLLER

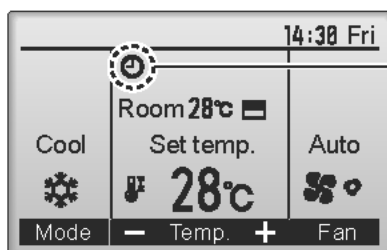

The clock icon will appear on the Main display in the Full mode when the On/Off timer is enabled.

5. Timer



5.2. Auto-OFF timer

Button operation

[1]

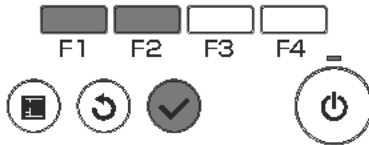
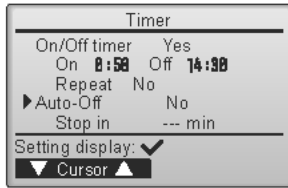

Bring up the Timer setting screen. (Refer to D-19)

Select "Auto-Off", and press the button.

The Auto-Off timer will not work in the following cases:

when Auto-Off timer is disabled, during an error, during check (in the service menu), during test run, during remote controller diagnosis, when the clock is not set, during Function setting, when the system is centrally controlled (when On/Off operation from local controller is prohibited).

[2]

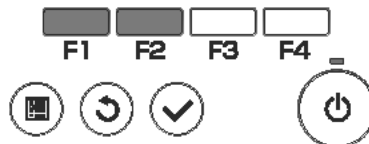
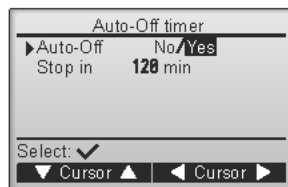

The current settings will appear.

Move the cursor to the "Auto-Off" or "Stop in --- min" with the or button.

[3]

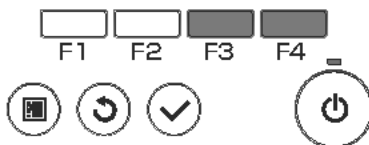
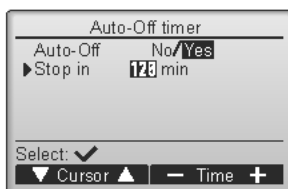

Change the setting with the or button.

- **Auto-Off** : No (disable) / Yes (enable)
- **Stop in --- min** : Timer setting
(The settable range is 30 to 240 minutes in 10-minute increments.)

[4]

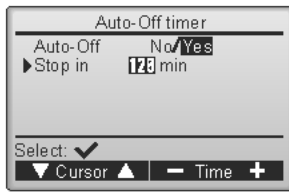

Press the button to save the settings.

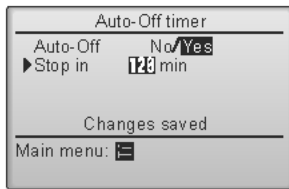
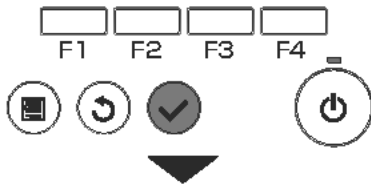

A confirmation screen will appear.

Navigating through the screens

- To go back to the Main menu button
- To return to the previous screen..... button

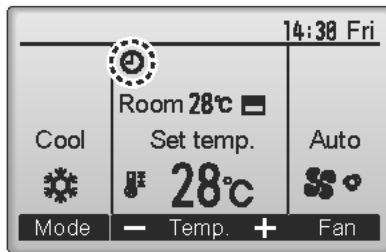

will appear on the Main display in the Full mode when the On/Off timer is enabled.

appears when the timer is disabled by the centralized control system.

6. Filter information

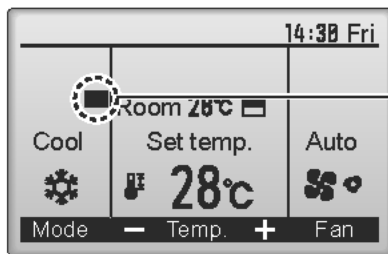

Filter icon will appear on the Main display in the Full mode when it is time to clean the filters.
Wash, clean, or replace the filters when this sign appears.
 Refer to the indoor unit Instructions Manual for details.

Button operation

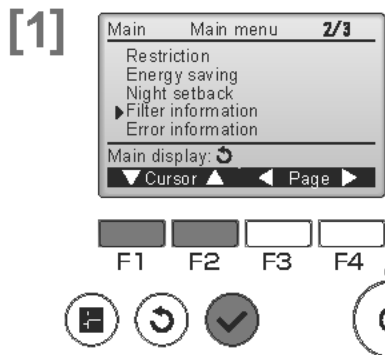

Select "Filter information" from the Main menu (refer to D-15), and press the button.

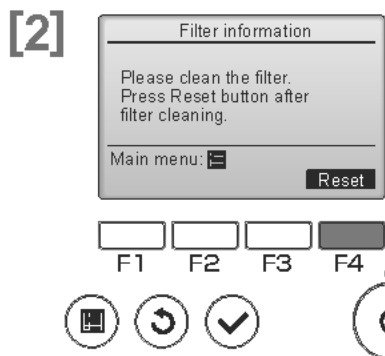

Press the **F4** button to reset filter sign.
 Refer to the indoor unit Instructions Manual for how to clean the filter.

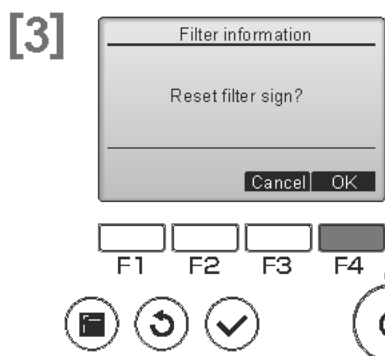

Select "OK" with the **F4** button.

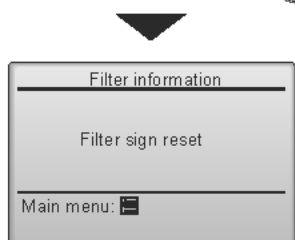

A confirmation screen will appear.

- Navigating through the screens**
- To go back to the Main menu button
 - To return to the previous screen button

MA REMOTE CONTROLLER V. CONTROLLER OPERATION-BASIC OPERATIONS [PAR-33MAA]

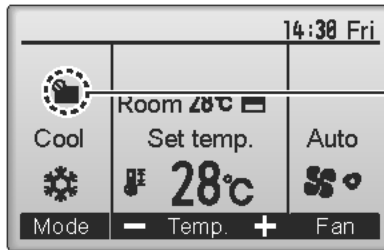

When the  is displayed on the Main display in the Full mode, the system is centrally controlled and the filter sign cannot be reset.

If two or more indoor units are connected, filter cleaning timing for each unit may be different, depending on the filter type.

The icon  will appear when the filter on the main unit is due for cleaning.

When the filter sign is reset, the cumulative operation time of all units will be reset.

The icon  is scheduled to appear after a certain duration of operation, based on the premise that the indoor units are installed in a space with ordinary air quality. Depending on the air quality, the filter may require more frequent cleaning.

The cumulative time at which filter needs cleaning depends on the model.

7. Error information

When an error occurs, the following screen will appear.
Check the error status, stop the operation, and consult your dealer.

Button operation

[1]

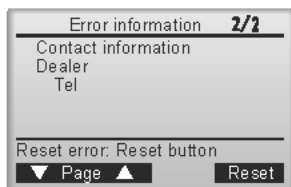
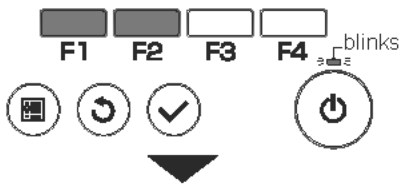
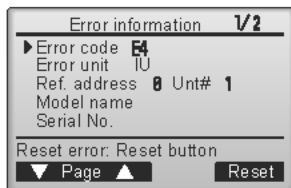

Error code, error unit, refrigerant address, unit model name, and serial number will appear.
The model name and serial number will appear only if the information have been registered.

Press the **F1** or **F2** button to go to the next page.

Contact information (dealer's phone number) will appear if the information have been registered.

[2]

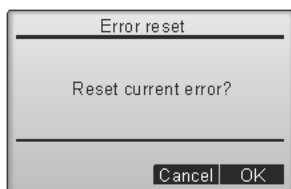
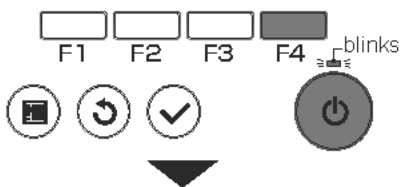
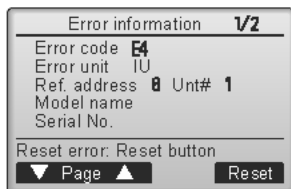

Press the **F4** button or the  button to reset the error that is occurring.

Errors cannot be reset while the ON/OFF operation is prohibited.

Select "OK" with the **F4** button.

Navigating through the screens

- To go back to the Main menu  button

Checking the error information

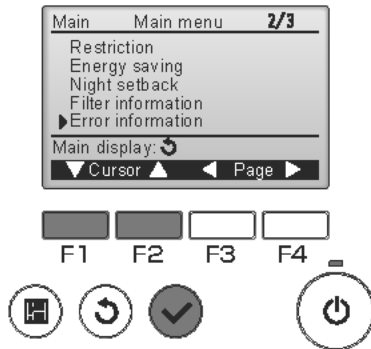

While no errors are occurring, page 2/2 of the error information (refer to D-25) can be viewed by selecting "Error information" from the Main menu (refer to D-15). Errors cannot be reset from this screen.

8. High power



High-power operation function allows the units to operate at higher-than-normal capacity so that the room air can be conditioned to an optimum temperature quickly. This operation will last for up to 30 minutes, and the unit will return to the normal operation mode at the end of the 30 minutes or when the room temperature reaches the preset temperature, whichever is earlier. The units will return to the normal operation when the operation mode or fan speed is changed.

Button operation

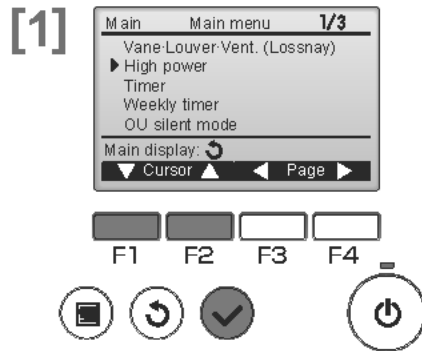

Select "High power" from the Main menu during Cooling, Heating, or AUTO operation (refer to D-15), and press the button.

"High power" function is available only on the models that support the function.

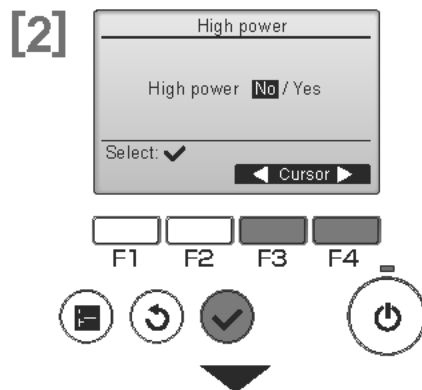

Move the cursor to "YES" with the or button, and press the .

A confirmation screen will appear.

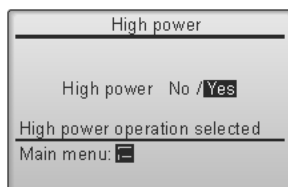

Navigating through the screens

- To go back to the Main menu
- To return to the previous screen.....

VI. Controller operation - Function settings

1. Weekly timer



- ON / OFF and temperature setting can be scheduled for each day.
- "Weekly timer" is not executed when the On / Off timer is enabled.

Button operation

[1]

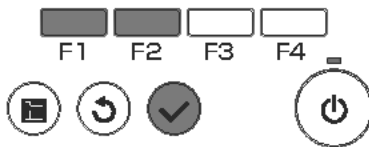
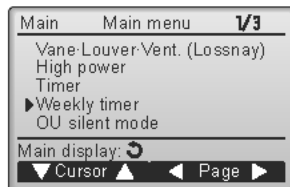

Select "Weekly timer" from the Main menu (refer to D-15), and press the button.

The Weekly timer will not work in the following cases:

when the On / Off timer is enabled, when the weekly timer is disabled, during an error, during check (in the service menu), during test run, during remote controller diagnosis, when the clock is not set, during Function setting, when the system is centrally controlled (On / Off operation or temperature setting from local controller is prohibited).

[2]

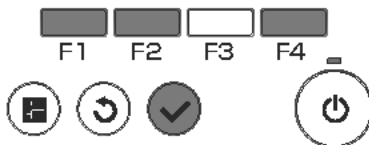
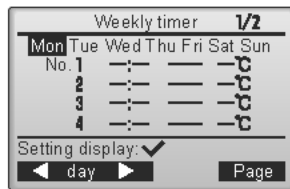

The current settings will appear.

Press the or button to see the settings for each day of the week.

Press the button to see patterns 5 through 8.



Press the button to go to the setting screen.

[3]

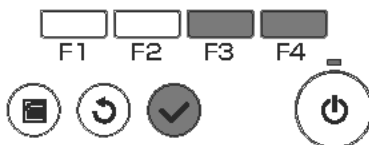
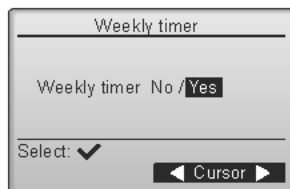

The screen to enable (Yes) and disable (No) the weekly timer will appear.

To enable the setting, move the cursor to "Yes" with the or button, and press the button.

[4]

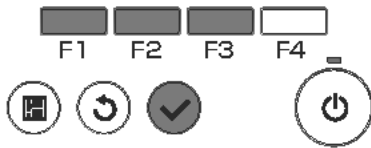
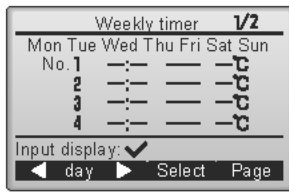

The weekly timer setting screen will appear and the current settings will be displayed.
Up to eight operation patterns can be set for each day.

Move the cursor to the desired day of the week with the **[F1]** or **[F2]** button, and press the **[F3]** button to select it. (Multiple days can be selected.)

Press the **✓** button.

[5]

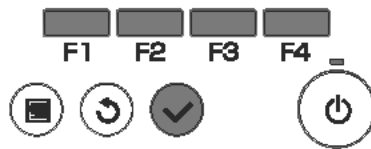
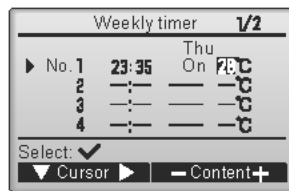

Operation pattern setting screen will appear.

Press the **[F1]** button to move the cursor to the desired pattern number. Move the cursor to the time, On / Off, or temperature with the **[F2]** button. Change the settings with the **[F3]** or **[F4]** button.

- **Time:** settable in 5-minute increments
* Press and hold the button to rapidly advance the numbers.
- **On / Off:**
- **Temperature:** The settable temperature range depends on the connected indoor units. (1°C increments)
When the Auto (dual set point) mode is selected, two preset temperatures can be set. If an operation pattern with a single preset temperature setting is executed during the Auto (dual set point) mode, its setting will be used as the cooling temperature setting in the Cool mode.

Press the **✓** button to save the settings.

A confirmation screen will appear.

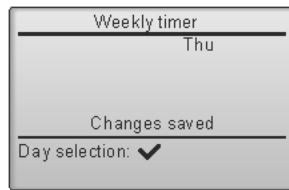

Navigating through the screens

- To go back to the setting change/day of the week selection screen **✓** button
- To go back to the Main menu **☐** button
- To return to the previous screen **↶** button

VI. CONTROLLER OPERATION-FUNCTION SETTINGS (PAR-33MAA)

M/A REMOTE CONTROLLER

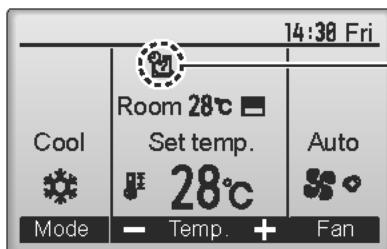

🕒 will appear on the Main display in the Full mode when the weekly timer setting for the current day exists.
The icon will not appear while the On/Off timer is enabled or the system is under centralized control (Timer operation from local remote controller is prohibited).

2. OU silent mode



This function allows the user to set the time periods in which priority is given to quiet operation of outdoor units over temperature control. Set the start and stop times each day of the week for the quiet operation. Select the desired silent level from "Middle" and "Quiet".

Button operation

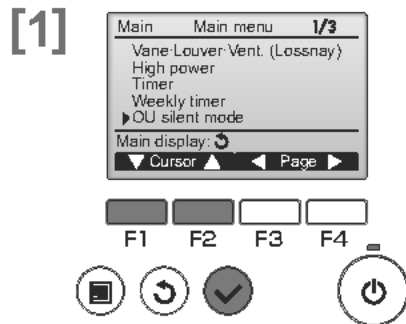

Select "OU silent mode" from the Main menu (refer to D-15), and press the button.

"OU silent mode" function is available only on the models that support the function.

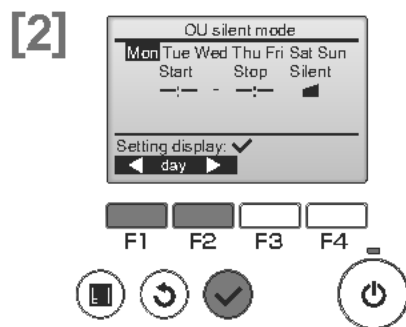

The current settings will appear.

Press the or button to see the settings for each day of the week.

Press the button to go to the setting screen.

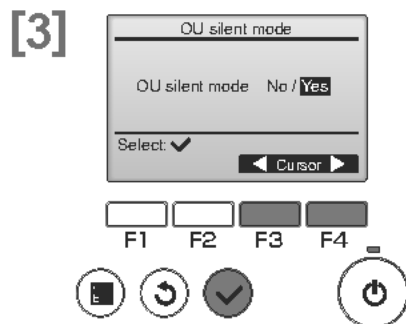

The screen to enable (Yes) and disable (No) the silent mode will appear.

To enable this setting, move the cursor to "Yes" with the or button, and press the button.

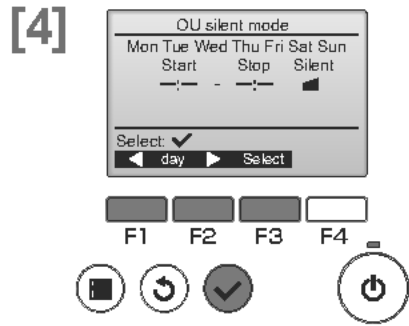

The OU silent mode setting screen will appear.

To make or change the setting, move the cursor to the desired day of the week with the [F1] or [F2] button, and press the [F3] button to select it. (Multiple days can be selected.)

Press the button.

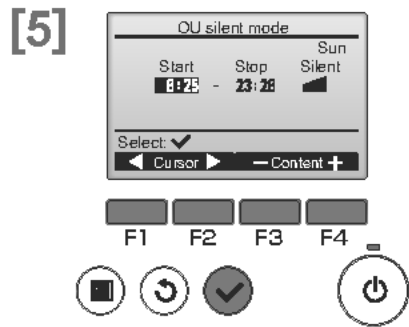

The setting screen will appear.

Move the cursor to the desired item with the [F1] or [F2] button out of Start time, Stop time, or Silent level.

Change the settings with the [F3] or [F4] button.

- Start/Stop time: settable in 5-minute increments
* Press and hold the button to rapidly advance the numbers.
- Silent level: Normal, Middle, Quiet



Press the button to save the settings. A confirmation screen will appear.

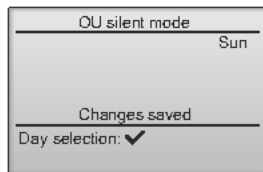

Navigating through the screens

- To go back to the setting change/day of the week selection screen button
- To go back to the Main menu button
- To return to the previous screen button

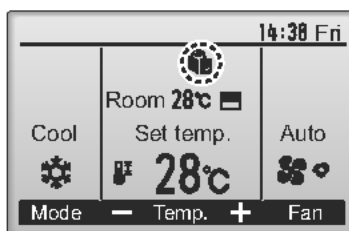

will appear on the Main display in the Full mode during the OU silent mode.

3. Energy saving



3.1. Automatic return to the preset temperature

After the Auto return function is enabled, when the operation mode change or ON/OFF operation is performed from this remote controller, the set temperature automatically returns to the required temperature regardless of the set time.

Button operation

[1]

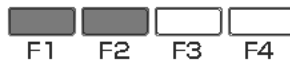
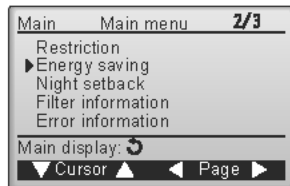

Select "Energy saving" from the Main menu (refer to D-15), and press the button.

[2]

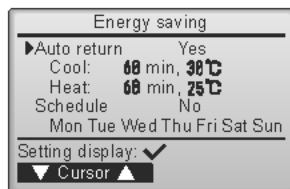

The current settings will appear.

Move the cursor to "Auto return" with the or button, and press the button.

[3]

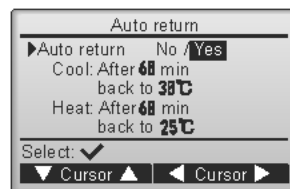

The screen to make the settings for the automatic return to the preset temperature will appear.

Move the cursor to the desired item with the or button out of "Auto return", "Cool" or "Heat".

[4]

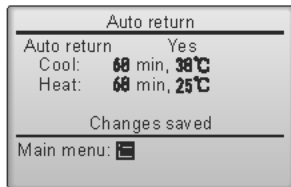
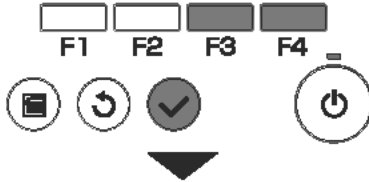
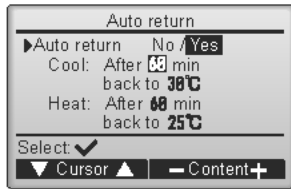

Change the settings with the **F3** or **F4** button.

- **Auto return:** No (disable) / Yes (enable)
- **Cool:** Timer setting range is 30 to 120 minutes in 10-minute increments. Temperature setting range is 19 to 30°C (67 to 87°F).
- **Heat:** Timer setting range is 30 to 120 minutes in 10-minute increments. Temperature setting range is 17 to 28°C (63 to 83°F).

Press the button to save the settings.

The screen to set the selected item will appear.

Navigating through the screens

- To go back to the Main menu button
- To return to the previous screen button

The above settings will not be effective when the Temp. range is restricted and when the system is centrally controlled (when the Temp. range setting from local controller is prohibited). When the system is centrally controlled (When timer operation from local remote controller is prohibited), only the Timer setting will be ineffective.

<Sample screens when the Auto return function is enabled>

Example: Lower the Set temp. to 24°C (75°F). 60 minutes later, the Set temp. will be back to 28°C (83°F).

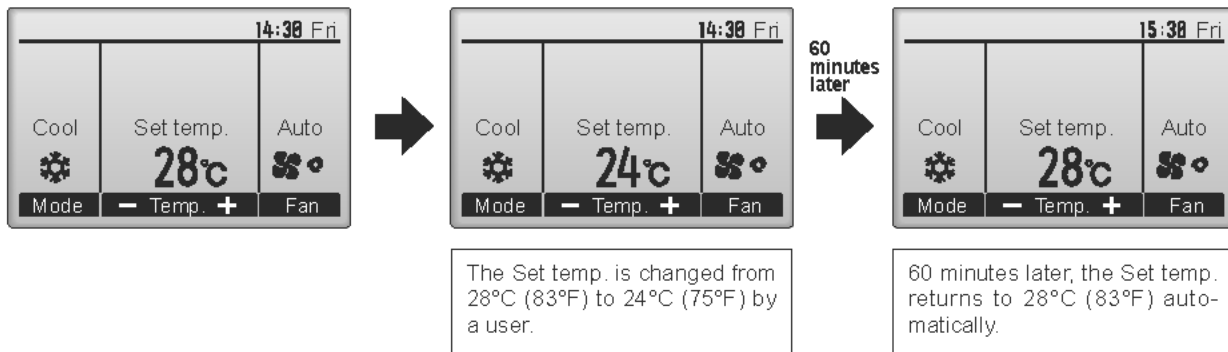

VI. CONTROLLER OPERATION-FUNCTION SETTINGS (PAR-33MAA)

MA REMOTE CONTROLLER

3. Energy saving



3.2. Setting the energy-saving operation schedule

Set the Energy-saving operation start time, end time and performance save value for one week.

Button operation

[1]

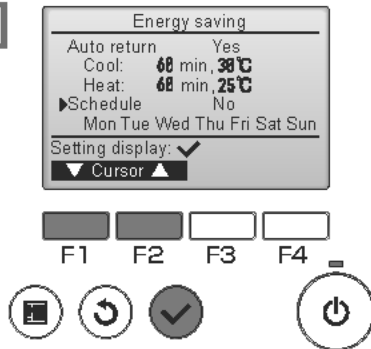

Bring up the "Energy saving" screen. (refer to D-31)

Move the cursor to the "Schedule," and press the button.

[2]

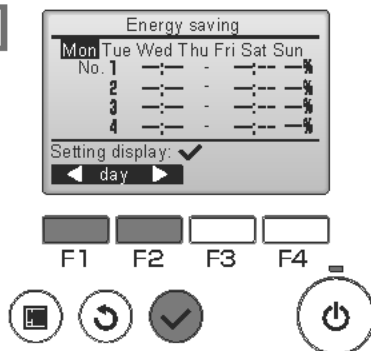

The screen to see the schedule will appear.

Press the or button to see the settings for each day of the week.

Press the button to go to the setting screen.

[3]

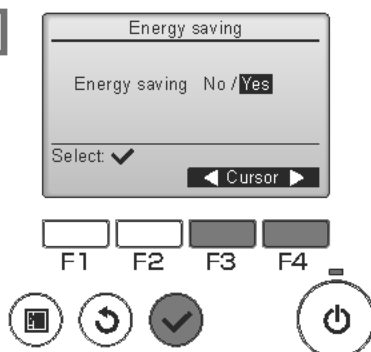

The screen to enable (Yes)/disable (No) the energy-saving operation schedule will appear.

Select "No" or "Yes" with the or button.

Press the button to go to the setting change/day of the week selection screen.

[4]

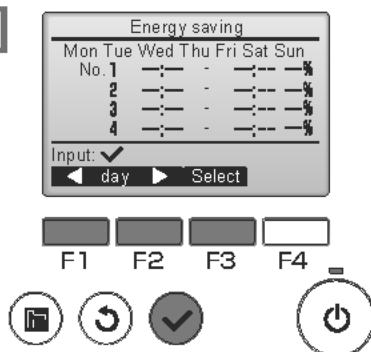

The setting change / day of the week selection screen will appear.

* Up to four operation patterns can be set for each day.

Move the cursor to the desired day of the week with the or button, and press the button to select it. (Multiple days can be selected.)

Press the button to go to the pattern setting screen.

[5]

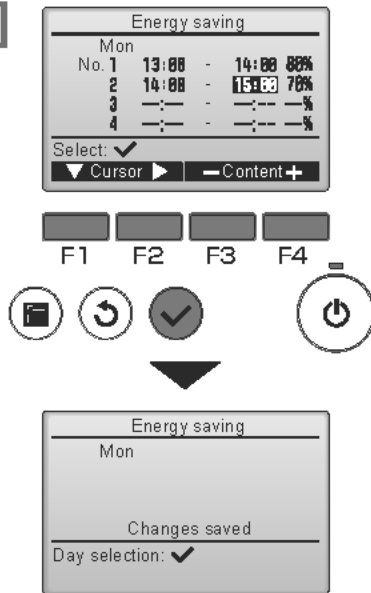

The pattern setting screen will appear.

Press the **[F1]** button to move the cursor to the desired pattern number.



Move the cursor to the desired item with the **[F2]** button out of the start time, stop time, and energy-saving rate (arranged in this order from the left).



Change the settings with the **[F3]** or **[F4]** button.

- **Start/Stop time:** settable in 5-minute increments
* Press and hold the button to rapidly advance the numbers.
- **Energy-saving rate:** The setting range is 0%, 50%, 60%, 70%, 80%, 90%.

Press the button to save the settings.

A confirmation screen will appear.

- The lower the value, the greater the energy-saving effect.

Navigating through the screens

- To go back to the setting change/day of the week selection screen button
- To go back to the Main menu button
- To return to the previous screen button

♦ Overlapping times can be set. Refer to <Example 2> for details on the operation methods.

<Example 1>

- pattern1/ 8:15~12:00/ 90%
- pattern2/ 12:00~17:00/ 80%
- pattern3/ 18:00~21:00/ 90%
- pattern4/ 8:15~12:00/ 90%

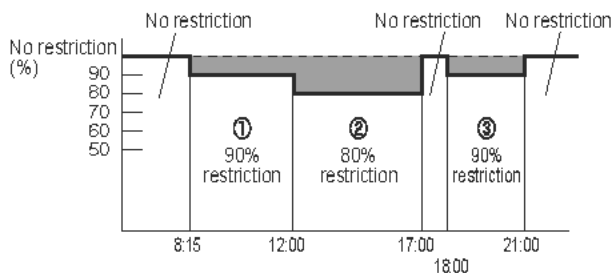

<Example 2>

- pattern1/ 8:15~21:00/ 90%
- pattern2/ 12:00~16:00/ 70%
- pattern3/ 16:00~19:00/ 90%
- pattern4/ 8:15~12:00/ 90%

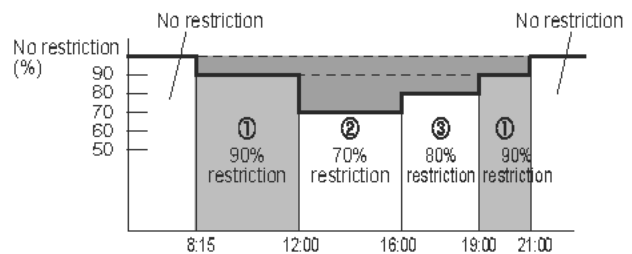

VI. CONTROLLER OPERATION-FUNCTION SETTINGS (PAR-33MAA)

MA REMOTE CONTROLLER

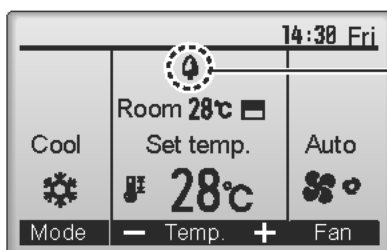

will appear on the Main display in the Full mode when the unit is operated in the energy saving mode.

Settings can be made with external inputs to the outdoor unit.

4. Night setback



This control starts heating operation when the control object group is stopped and the room temperature drops below the preset lower limit temperature. Also, this control starts cooling operation when the control object group is stopped and the room temperature rises above the preset upper limit temperature.

The Night setback function is not available if the operation and the temperature setting are performed from the remote controller.

If the room temperature is measured by the air-conditioner's suction temperature sensor, the accurate temperature may not be obtained when the air-conditioner is inactive or when the air is not clean. In this case, switch the sensor to a remote sensor (PAC-SE40TSA/PAC-SE41TS-E) or a remote control sensor.

Button operation

[1]

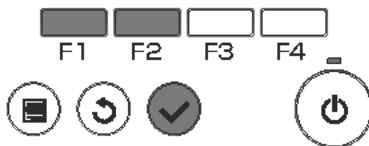
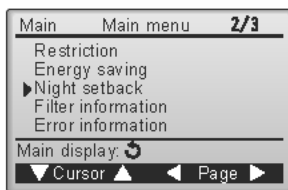

Select "Night setback" from the Main menu (refer to D-15), and press the button.

[2]

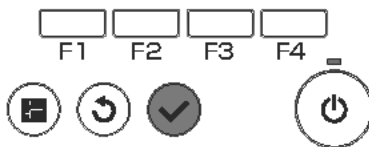
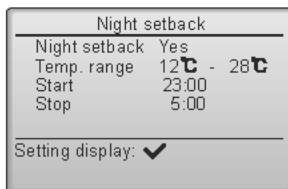

The current settings will appear.

Press the button to go to the setting screen.

[3]

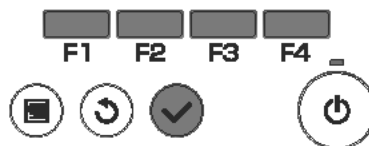
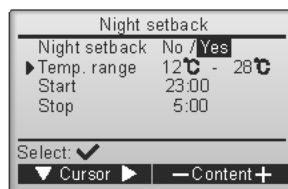

Move the cursor to the desired item with the **F1** or **F2** button out of Night setback No (disable)/Yes (enable), Temp. range, Start time, or Stop time.

Change the settings with the **F3** or **F4** button.

- **Temp. range:** The lower limit temperature (for heating operation) and the upper limit temperature (for cooling operation) can be set. The temperature difference between the lower and upper limits must be 4°C (8°F) or more. The settable temperature range varies depending on the connected indoor units.
* 1°C increments
- **Start/Stop time:** settable in 5-minute increments
* Press and hold the button to rapidly advance the numbers.

Press the button to save the settings.

A confirmation screen will appear.

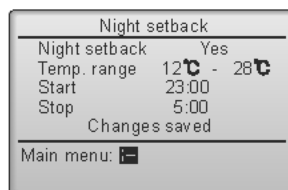

Navigating through the screens

- To go back to the Main menu button
- To return to the previous screen..... button

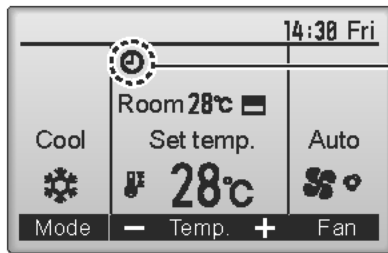

 will appear on the Main display in the Full mode when the Night setback function is enabled.

 appears when the timer is disabled by the centralized control system.

The Night setback will not work in the following cases:

when the unit is in operation, when the Night setback function is disabled, during an error, during check (in the service menu), during test run, during remote controller diagnosis, when the clock is not set, during Function setting, when the system is centrally controlled (On/Off operation or temperature setting from local controller is prohibited).

5. Restriction



5.1. Setting the temperature range restriction

Use to restrict the preset temperature range.

Button operation

[1]

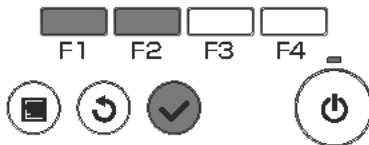
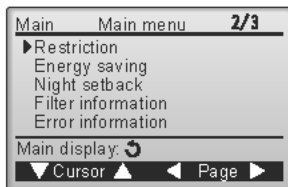

Select "Restriction" from the Main menu (refer to D-15), and press the button.

[2]

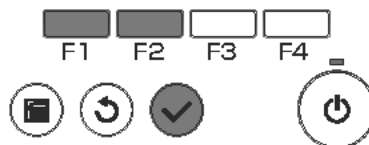
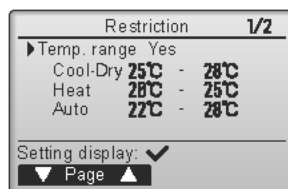

The current settings will appear.

Move the cursor to "Temp. range" with the **F1** or **F2** button, and press the button.

[3]

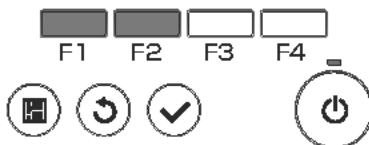
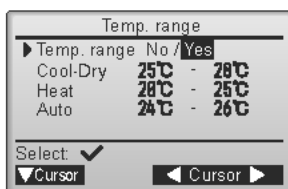

The screen to set the temperature range will appear.

Move the cursor to the desired item with the **F1** button out of "Temp. range", "Cool · Dry", "Heat" or "Auto."

[4]

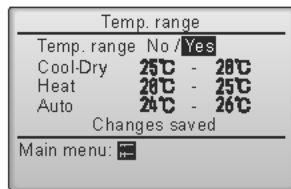
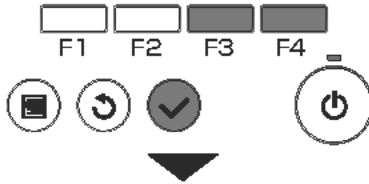
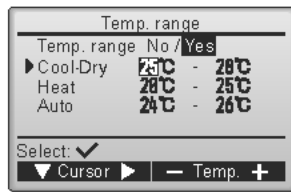

Change the settings with the **F3** or **F4** button.

- **Temp. range:** No (unrestricted) or Yes (restricted)
- **Cool · Dry:** Upper and lower limit temperature (1°C increments)
- **Heat:** Upper and lower limit temperature (1°C increments)
- **Auto:** Upper and lower limit temperature (1°C increments)

<Temperature setting ranges>

Mode	Lower limit	Upper limit
Cool·Dry *1 *3	19 ~ 30°C (67 ~ 87°F)	30 ~ 19°C (87 ~ 67°F)
Heat *2 *3	17 ~ 28°C (63 ~ 83°F)	28 ~ 17°C (83 ~ 63°F)
Auto *4	19 ~ 28°C (67 ~ 83°F)	28 ~ 19°C (83 ~ 67°F)

- * The settable range varies depending on the connected unit.
- *1 Temperature ranges for the Cool, Dry, and Auto (dual set point) modes can be set.
- *2 Temperature ranges for the Heat and Auto (dual set point) modes can be set.
- *3 Temperature ranges for the Heat, Cool, and Dry modes must meet the conditions below:
 - Upper limit for cooling - upper limit for heating ≥ Minimum temperature difference (varies with indoor unit model)
 - Lower limit for cooling - lower limit for heating ≥ Minimum temperature difference (varies with indoor unit model)
- *4 Temperature range for the Auto (single set point) mode can be set.

Press the button to save the settings.

A confirmation screen will appear.

Navigating through the screens

- To go back to the Main menu button
- To return to the previous screen button

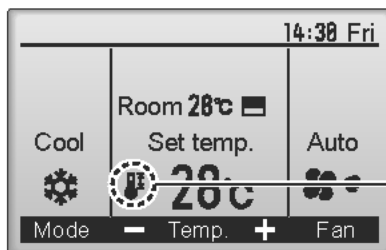

will appear on the Main display in the Full mode when the temperature range is restricted.



5. Restriction

5.2. Operation lock function

- To enable the operation lock function, set the item "Operation locked" to "Yes".
- The On / Off operation, Operation mode setting, Preset temp., Setting and Vane Setting operations can all be restricted.

Button operation

[1]

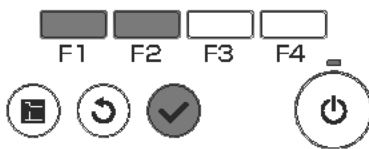
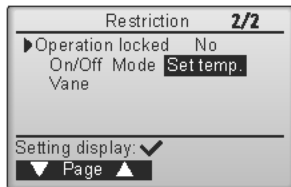

Bring up the Restriction setting screen. (refer to D-37)

Move the cursor to "Operation locked" and press the button.

[2]

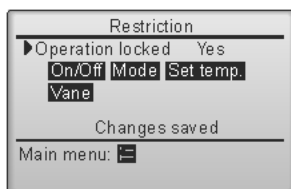
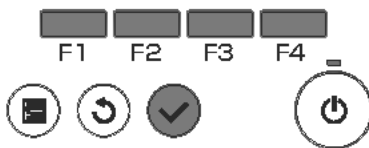
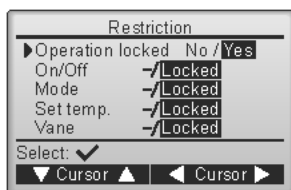

The screen to make the settings for the operation lock function will appear.

Move the cursor to the desired item with the [F1] or [F2] button out of "Operation locked", "On / Off", "Mode", "Set temp.", or "Vane".

Change the settings with the [F3] or [F4] button.

- **Operation locked:** No (disable) / Yes (enable)
- **On / Off:** On/Off operation
- **Mode:** Operation mode setting
- **Set temp.:** Preset temp. setting
- **Vane:** Vane setting

Press the button to save the settings.

A confirmation screen will appear.

Navigating through the screens

- To go back to the Main menu button
- To return to the previous screen button

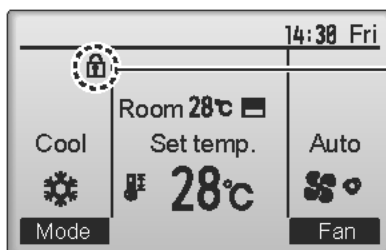

(When Set temp. is locked)

will appear on the Main display in the Full mode when the operation lock function setting is enabled.

Operation guide that corresponds to the locked function will be suppressed.

"Operation locked" will appear if operation is attempted in the "Operation locked" state.

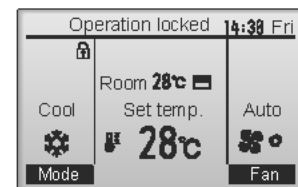

VII. Maintenance

1. Auto descending panel



Button operation

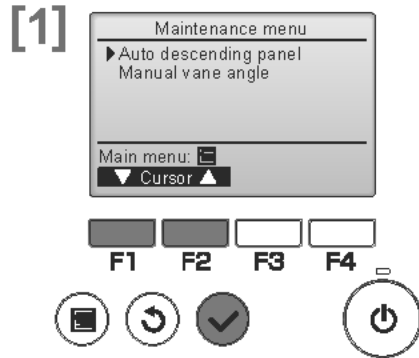

Select "Maintenance" from the Main menu (refer to D-15), and press the button.

Select "Auto descending panel" with the **F1** or **F2** button, and press the button.

* When using the auto descending panel, always set the "Address" and "Unit No." with "Service" – "Function setting".

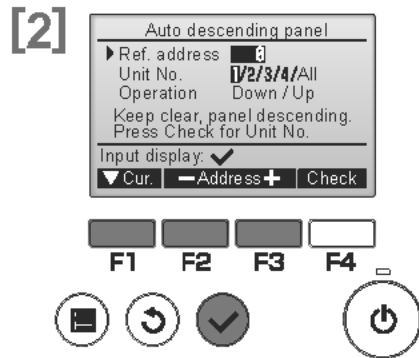

Move the cursor to "Ref. address", "Unit No." or "Operation" with the **F1** button to select.

Select the refrigerant address and the unit number for the units to whose falls panel, with the **F2** or **F3** button, and press the button.

- Ref. address: Refrigerant address
- Unit No.: 1, 2, 3, 4
- Operation: Down / Up

Press the **F4** button to confirm the unit.

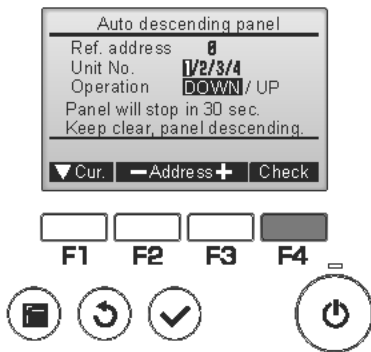

<Confirmation of target unit>
 If the unit being set is unknown, make the setting and then press the **F4** button to confirm.
 The air conditioner which is blowing downward is the target air conditioner.

Navigating through the screens
 • To return to the previous screen..... button

VII. MAINTENANCE (PAR-33MAA)

M/A REMOTE CONTROLLER

2. Manual vane angle



Applies to the of Ceiling cassette type.
Use to set the vane angle for each vane to a fixed position.

Button operation

[1]

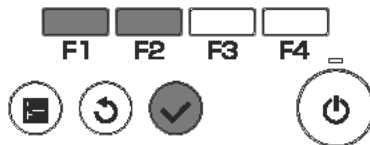
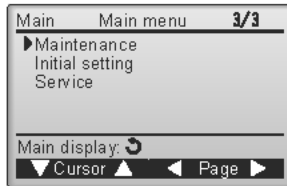

Select "Maintenance" from the Main menu (refer to D-15), and press the button.

[2]

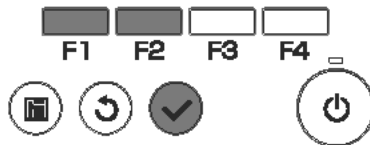

Select "Manual vane angle" with the **[F1]** or **[F2]** button, and press the button.

[3]

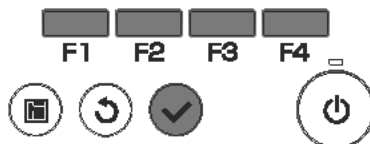
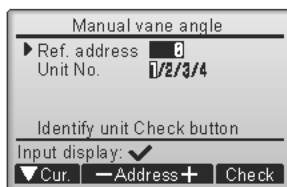

Move the cursor to "Ref. address", "Unit No." or "Operation" with the **[F1]** button to select.



Select the refrigerant address and the unit number for the units to whose vanes are to be fixed, with the **[F2]** or **[F3]** button, and press the button.

- Ref. address: Refrigerant address
- Unit No.: 1, 2, 3, 4



Press the **[F4]** button to confirm the unit.

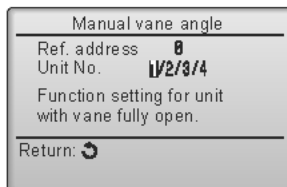

<Confirmation of target unit>

If the unit being set is unknown, make the setting and then press the **[F4]** button to confirm.

The air conditioner which is blowing downward is the target air conditioner.

The screen at left shows a sample display on Mr. Slim. On City Multi units, "M-NET address," is displayed instead of "Ref. address", and the "Unit No." will not be displayed.

[4]

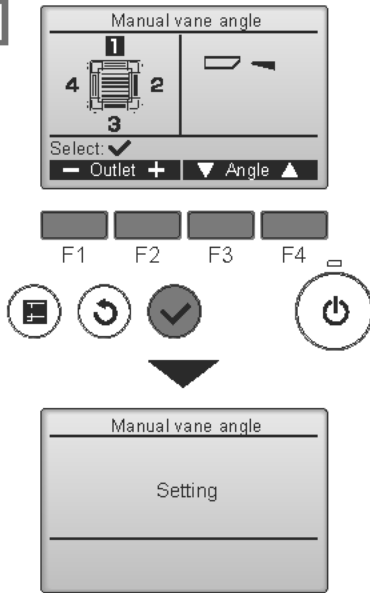

The current vane setting will appear.

Select the desired outlets from 1 through 4 with the **F1** or **F2** button.

- Outlet: "1," "2," "3," "4," and "1, 2, 3, 4, (all outlets)"

Press the **F3** or **F4** button to go through the option in the order of "No setting (reset)," "Step 1," "Step 2," "Step 3," "Step 4," "Step 5," and "Step 6."

Select the desired setting.

*Step 6 can only be set for one outlet.

<Vane setting>

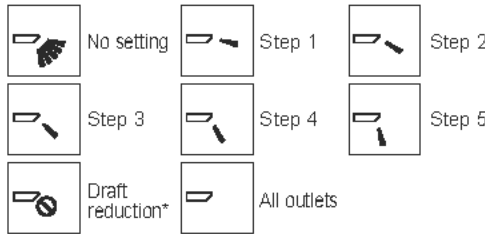

* Draft reduction
The airflow direction for this setting is more horizontal than the airflow direction for the "Step 1" setting in order to reduce a drafty feeling. The draft reduction can be set for only 1 vane.

Press the button to save the settings.

A screen will appear that indicates the setting information is being transmitted.

The setting changes will be made to the selected outlet.

The screen will automatically return to the one shown above (step 4) when the transmission is completed.

Make the settings for other outlets, following the same procedures.

If all outlets are selected, will be displayed the next time the unit goes into operation.

Navigating through the screens
• To return to the previous screen button

***Draft reduction**
The [Draft reduction] mode keeps the vane angle more horizontal than the angle of Step 1 so that the airflow will not be directed toward the people.
This function can be set only for one outlet.
This function cannot be set for models with two or three outlets.
In the Draft reduction mode, the airflow may cause the ceiling discoloration.

VI. MAINTENANCE (PAR-33MAA)

MA REMOTE CONTROLLER

3. 3D i-see Sensor setting



3.1. 3D i-see Sensor setting

Button operation

[1]

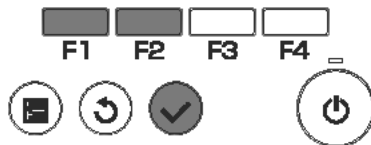
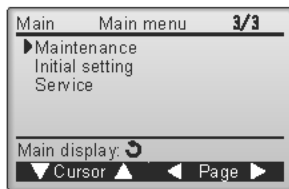

Select "Maintenance" from the Main menu (refer to D-15), and press the button.

[2]

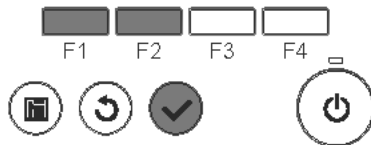

Select "3D i-See sensor" with the **F1** or **F2** button, and press the button.

[3]

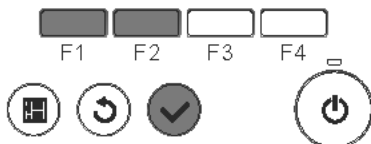
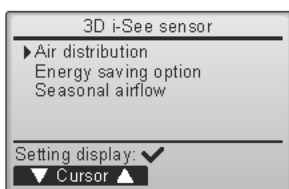

Select the desired menu with the **F1** or **F2** button, and press the button.

- **Air distribution**
Select the airflow direction control method when the airflow direction is set to "Auto".
- **Energy saving option**
Operates the energy-save mode according to whether persons are detected in the room by the 3D i-see Sensor.
- **Seasonal airflow**
When the thermostat turns off, the fan and the vanes operate according to the control settings.

3.2. Air distribution

Button operation

[1]

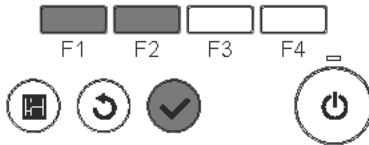
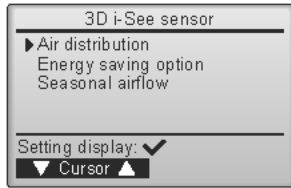

Select "Maintenance" from the Main menu (refer to D-15), and press the button.



Select "3D i-See sensor" with the **[F1]** or **[F2]** button, and press the button.



Select "Air distribution" with the **[F1]** or **[F2]** button, and press the button.

[2]

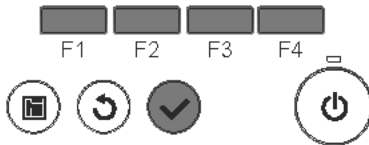
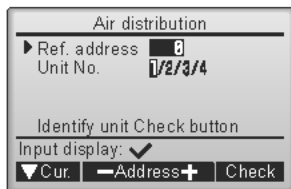

Move the cursor to "Ref. address", "Unit No." or "Operation" with the **[F1]** button to select.



Select the refrigerant address and the unit number for the units to whose vanes are to be fixed, with the **[F2]** or **[F3]** button, and press the button.

- Ref. address: Refrigerant address
- Unit No.: 1, 2, 3, 4



Press the **[F4]** button to confirm the unit.

<Confirmation of target unit>
 If the unit being set is unknown, make the setting and then press the **[F4]** button to confirm.
 The air conditioner which is blowing downward is the target air conditioner.

The vane of only the target indoor unit is pointing downward.

[3]



Select the menu with the **[F4]** button.

Default → Area → Direct/Indirect → Default...



Default: The vanes move the same as during normal operation.

During cooling mode, all of the vanes move to the horizontal airflow direction.

During heating mode, all of the vanes move to the down airflow direction.

Area: The vanes move to the down airflow direction toward areas with a high floor temperature during cooling mode and toward areas with a low floor temperature during heating mode. Otherwise, the vanes move to the horizontal airflow direction.

Direct/Indirect: The vanes automatically move relative to the areas where persons are detected.

The vanes operate as indicated in the following table.

	Vane setting	
	Direct	Indirect
Cooling	horizontal → swing	keep horizontal
Heating	keep downward	downward → horizontal

[4]

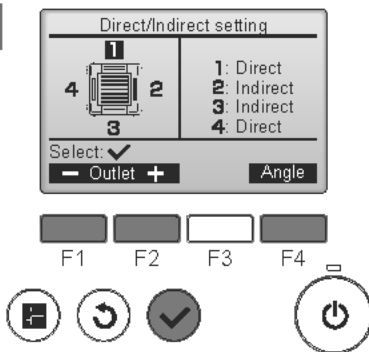

When Direct/Indirect is selected, set each air outlet.

Select the air outlet with the **[F1]** or **[F2]** button, and change the setting with the **[F4]** button.



After changing the settings for all of the air outlets, press the **[✓]** button to save the settings.

* In order to enable this function, the airflow direction must be set to "Auto".

3.3. Energy saving option

Button operation

[1]

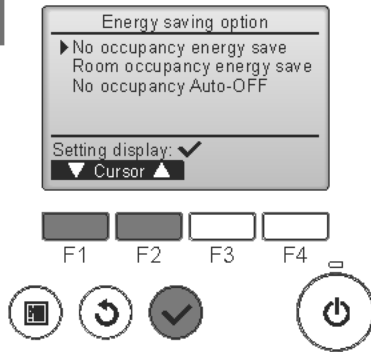

Select "Maintenance" from the Main menu (refer to D-15), and press the button.



Select "3D i-See sensor" with the **[F1]** or **[F2]** button, and press the button.



Select "Energy saving option" with the **[F1]** or **[F2]** button, and press the button.



Select the desired menu with the **[F1]** or **[F2]** button.

- **No occupancy energy save**
If there are no persons in the room for 60 minutes or more, energy-saving operation equal to 2 °C is performed.
- **Room occupancy energy save**
If the occupancy rate decreases to approximately 30% of the maximum occupancy rate, energy-saving operation equal to 1 °C is performed.
- **No occupancy Auto-OFF**
If there are no persons in the room for the set amount of time (60–180 minutes), the operation is automatically stopped.

[2]

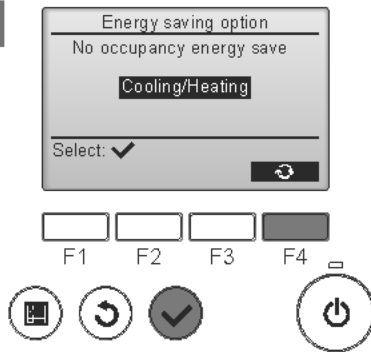

When No occupancy energy save or Room occupancy energy save is selected.

Select the setting with the **[F4]** button.
OFF → Cooling only → Heating only → Cooling/Heating → OFF...

After changing the setting, press the button to save the setting.

[3]

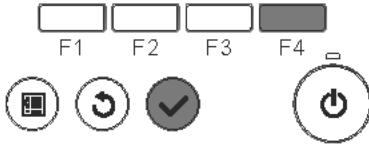
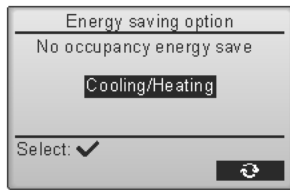

OFF: The function is disabled.
 Cooling only: The function is enabled only during cooling mode.
 Heating only: The function is enabled only during heating mode.
 Cooling/Heating: The function is enabled during both cooling mode and heating mode.

[4]

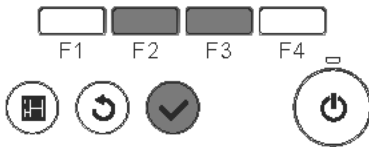
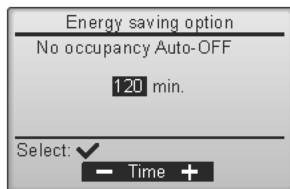

When No occupancy Auto-OFF is selected
 Set the time with the [F3] or [F4] button.
 ---: The setting is disabled (the operation will not stop automatically).
 60-180: The time can be set in 10-minute increments.

[5]

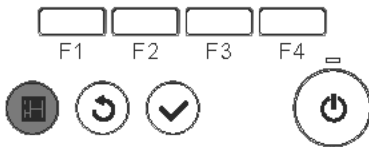
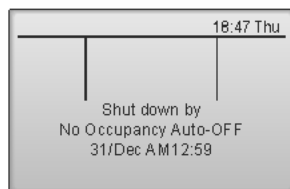

The message at left will appear if the operation was stopped automatically by the No occupancy Auto-OFF setting.

3.4. Seasonal airflow function

Button operation

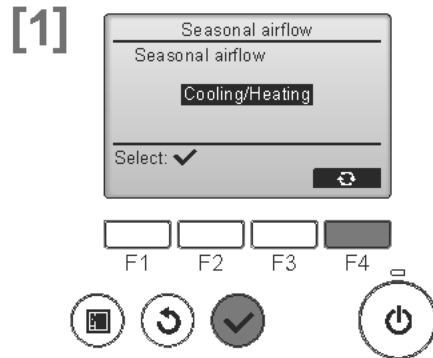

Select "Maintenance" from the Main menu (refer to D-15), and press the button.



Select "3D i-See sensor" with the **F1** or **F2** button, and press the button.



Select "Seasonal airflow" with the **F1** or **F2** button, and press the button.

Select the setting with the **F4** button.

OFF → Cooling only → Heating only → Cooling/Heating → OFF...

After changing the setting, press the button to save the setting.

OFF: The function is disabled.

Cooling only: When the thermostat turns off during cooling mode, the vanes move up and down.

Heating only: When the thermostat turns off during heating mode, the vanes move to the horizontal airflow direction to circulate the air.

Cooling/Heating: The function is enabled during both cooling mode and heating mode.

* In order to enable this function, the airflow direction must be set to "Auto".

VIII. Initial setting

1. Main / Sub



When connecting two remote controllers, one of them needs to be designated as a sub controller.

Button operation

[1]

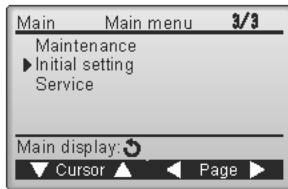

Select "Initial setting" from the Main menu (refer to D-15), and press the button.

[2]

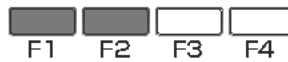
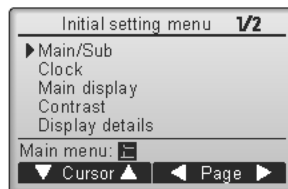

Move the cursor to the "Main / Sub" with the or button, and press the button.

[3]

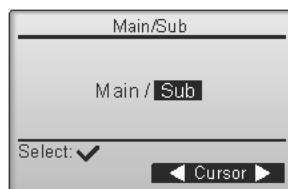

Select "Main" or "Sub" with the or button, and press the button.

If the setting is changed from "Sub remote controller" to "Main remote controller", automatically restart after changing the settings.

Navigating through the screens

- To go back to the Main menu button
- To return to the previous screen button

2. Clock P

Button operation

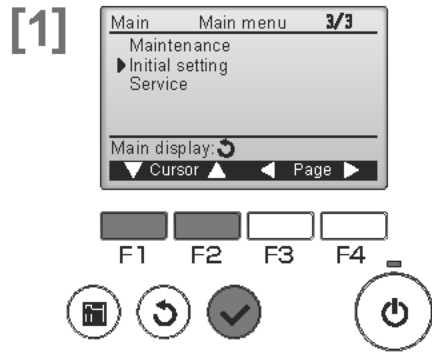

Select "Initial setting" from the Main menu (refer to D-15), and press the button.

Clock setting is required before making the following settings.

- On/Off timer
- Weekly timer
- Energy saving
- OU silent mode
- Night setback

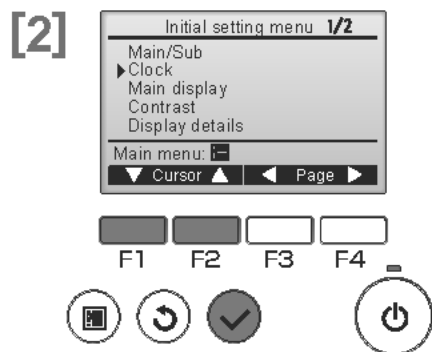

Move the cursor to the "Clock" with the **F1** or **F2** button, and press the button.

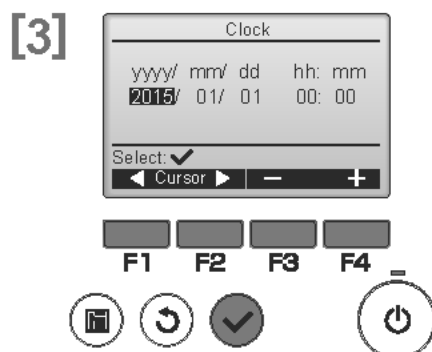

Move the cursor to the desired item with the **F1** or **F2** button out of year, month, date, hour or minute.



Increase or decrease the value for the selected item with the **F3** or **F4** button, and press the button.

A confirmation screen will appear.

Navigating through the screens

- To go back to the Main menu button
- To return to the previous screen..... button

10 INITIAL SETTING (PAR-33MAA)

MA REMOTE CONTROLLER

3. Main display



Button operation

[1]

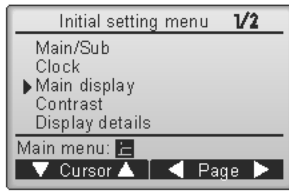

Select "Initial setting" from the Main menu (refer to D-15), and press the button.



Move the cursor to the "Main display" with the **[F1]** or **[F2]** button, and press the button.

[2]

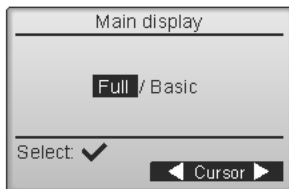

Select "Full" or "Basic" with the **[F3]** or **[F4]** button, and press the button. (The factory setting is "Full")

A confirmation screen will appear.

Navigating through the screens

- To go back to the Main menu button
- To return to the previous screen..... button

This setting is only for the Main Display. In the Basic mode, icons that indicate control status on timer and schedule settings will not appear on the display. Vane, louver, and ventilation settings or room temperature will not appear, either.

4. Contrast



Button operation

[1]

Initial setting menu 1/2
 Main/Sub
 Clock
 Main display
 ▶ Contrast
 Display details
 Main menu: [F1]
 ▼ Cursor ▲ ◀ Page ▶

F1 F2 F3 F4

Home Previous Next Power

Select "Initial setting" from the Main menu (refer to D-15), and press the button.



Move the cursor to the "Contrast" with the [F1] or [F2] button, and press the button.

[2]

Contrast

Main menu: [F1]
 Light Dark

F1 F2 F3 F4

Home Previous Next Power

Adjust the contrast with the [F3] or [F4] button, and press the or button.

Navigating through the screens

- To go back to the Main menu button
- To return to the previous screen..... button

V01 INITIAL SETTING (PAR-33MAA)

MA REMOTE CONTROLLER

5. Display detail setting



5.1. Clock

Button operation

[1]

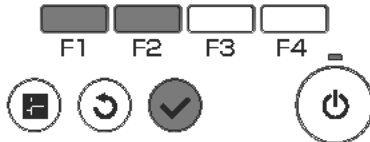
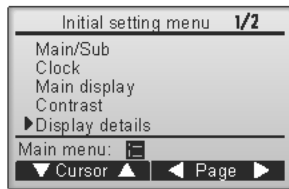

Select "Initial setting" from the Main menu (refer to D-15), and press the button.



Move the cursor to the "Display details" with the **[F1]** or **[F2]** button, and press the button.

[2]

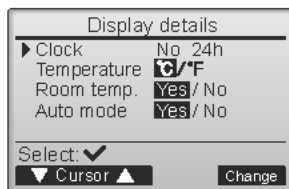

Move the cursor to the "Clock" with the **[F1]** or **[F2]** button, and change the setting with the **[F4]** button.

[3]

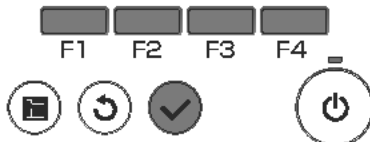
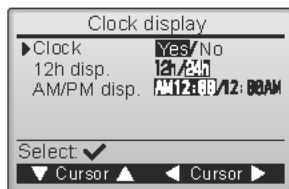

Move the cursor to the "Clock", "12 disp." or "AM / PM disp." with the **[F1]** or **[F2]** button, and change the setting with the **[F3]** or **[F4]** button.

The factory settings are "Yes" (display) and "24h" format.

- **Clock display:** Yes (Time is displayed on the Main display)
No (Time is not displayed on the Main display)
- **Display format:** 24h : 24h format
12h : 12h format
- **AM / PM display (Effective when the display format is 12-hour):**
AM / PM before the time [AM12:00]
AM / PM after the time [12:00AM]

note: Time display format will also be reflected on the time and schedule setting display. The time is displayed as shown below.

12-hour format : AM12:00 – AM1:00 – PM12:00 – PM1:00 – PM11:59
24-hour format : 0:00 – 1:00 – 12:00 – 13:00 – 23:59



Press the button to save the settings.

Navigating through the screens

- To go back to the Main menu button
- To return to the previous screen button

5. Display detail setting P

5.2. Temperature Unit, Room temp, Auto mode

Button operation

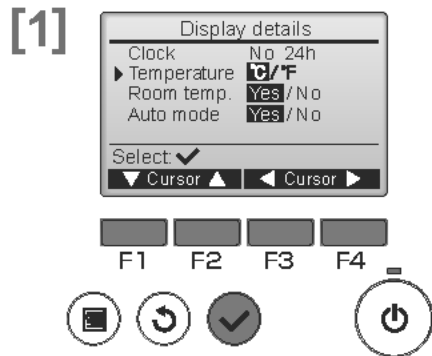

Select "Initial setting" from the Main menu (refer to D-15), and press the button.

Move the cursor to the "Display details" with the **F1** or **F2** button, and press the button.

Move the cursor to the "Temperature", "Room temp." or "Auto mode" with the **F1** or **F2** button, and change the setting with the **F3** or **F4** button.

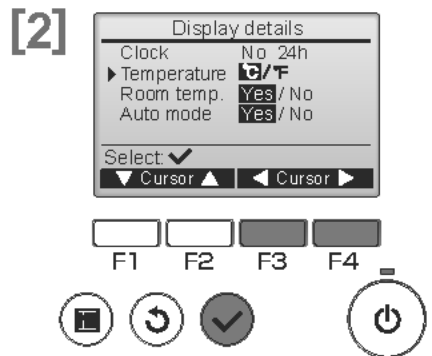

Change the setting with the **F3** or **F4** button.

- [1] Temperature unit setting (The factory default setting is Centigrade (°C))
- °C: Temperature is displayed in Centigrade. Temperature is displayed in 0.5- or 1-degree increments depending on the model of indoor units.
 - °F: Temperature is displayed in Fahrenheit.
 - 1°C: Temperature is displayed in centigrade in 1-degree increments. This item will not appear on a sub remote controller.
- [2] Room temperature display (The factory default setting is "Yes")
- Yes: Room temperature appears on the Main display.
 - No: Room temperature does not appears on the Main display.
- Note:
Even when "Yes" is set, the room temperature is not displayed on the Main display in the "Basic mode".
- [3] Auto mode setting (The factory setting is "Yes")
- Yes: "AUTO COOL" or "AUTO HEAT" is displayed during operation in the AUTO mode.
 - No: Only "AUTO" is displayed during operation in the AUTO mode.

Press the button to save the settings.

Navigating through the screens

- To go back to the Main menu button
- To return to the previous screen..... button

MA INITIAL SETTING (PAR-33MAA)

MA REMOTE CONTROLLER

6. Auto mode setting



Whether or not to use the Auto (single set point) or Auto (dual set points) mode can be selected by using the **[F3]** or **[F4]** button.

Button operation

[1]

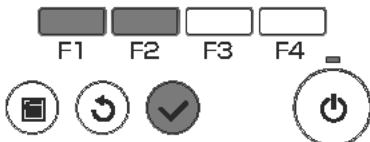
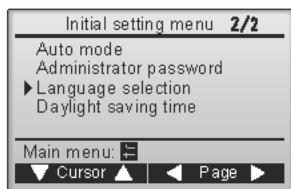

Select "Initial setting" from the Main menu (refer to D-15), and press the **[Confirm]** button.



Move the cursor to the "Auto mode" with the **[F1]** or **[F2]** button, and press the **[Confirm]** button.

[2]

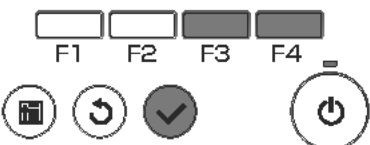
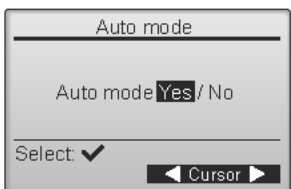

Change the setting with the **[F3]** or **[F4]** button.



Press the **[Confirm]** button to save the changes mode.

Auto mode setting : The factory default setting is "Yes".

- **Yes:** The AUTO mode can be selected in the operation mode setting.
- **No:** The AUTO mode cannot be selected in the operation mode setting.

Navigating through the screens

- To go back to the Main menu **[Home]** button
- To return to the previous screen **[Back]** button

7. Administrator password setting



The administrator password is required to make the settings for the following items.

- Timer setting • Energy-save setting • Weekly timer setting • Restriction setting
- Outdoor unit silent mode setting

Button operation

[1]

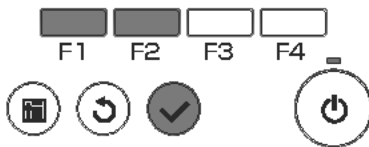
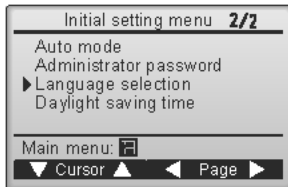

Select "Initial setting" from the Main menu (refer to D-15), and press the button.

Move the cursor to the "Administrator password" with the **F1** or **F2** button, and press the button.

[2]

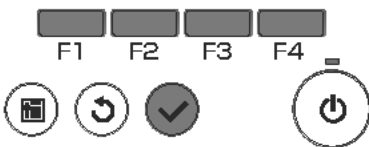
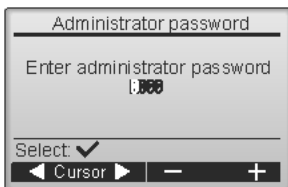

To enter the current Administrator password (4 numerical digits), move the cursor to the digit you want to change with the **F1** or **F2** button.

Set each number(0 through 9) with the **F3** or **F4** button.

Press the button.

note: The initial administrator password is "0000". Change the default password as necessary to prevent unauthorized access. Have the password available for those who need it.

: If you forget your administrator password, you can initialize the password to the default password "0000" by pressing and holding the **F1** and **F2** buttons simultaneously for three seconds on the administrator password setting screen.

[3]

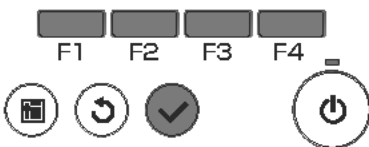
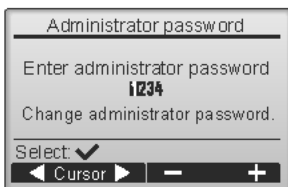

If the password matches, a window to enter a new password will appear.

Enter a new password in the same way as explained above, and press the button.

[4]

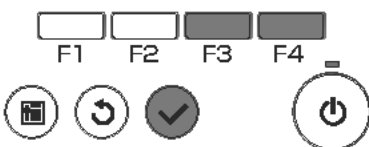
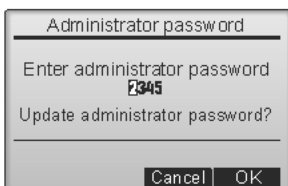

Press the **F4** button (OK) on the password change confirmation screen to save the change.

Press the **F3** button (Cancel) to cancel the change.

note: The administrator password is required to make the settings for the following items.

- Timer setting • Weekly timer setting • Energy-save setting
- Outdoor unit silent mode setting • Restriction setting

Refer to the Instruction Book that came with the remote controller for the detailed information about how to make the settings for these items.

8. Language selection



The desired language can be set. The language options are English, French, German, Spanish, Italian, Portuguese, Swedish, and Russian.

Button operation

[1]

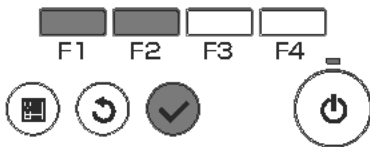
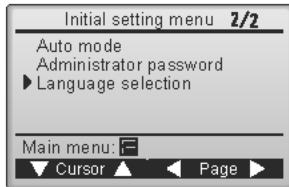

Select "Initial setting" from the Main menu (refer to D-15), and press the button.



Move the cursor to the "Language selection" with the **F1** or **F2** button, and press the button.

[2]

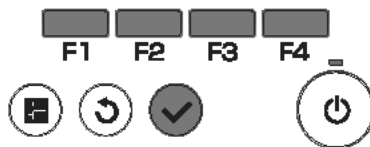
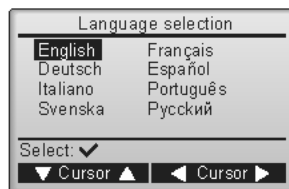

Move the cursor to the language you desire with the **F1** through **F4** buttons, and press the button to save the setting.

When the power is on for the first time, the Language selection screen will be displayed. Select a desired language. The system will not start-up without language selection.



A screen will appear that indicates the setting has been saved.

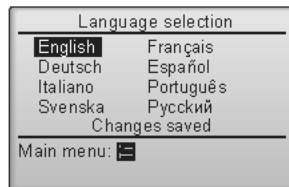

Navigating through the screens

- To go back to the Main menu button
- To return to the previous screen button

9. Daylight saving time



The start/end time for daylight saving time can be set. The daylight saving time function will be activated based on the setting contents.

- If a given system has a system controller, disable this setting to keep the correct time.
- At the beginning and the end of daylight saving time, the timer may go into action twice or not at all.
- This function will not work unless the clock has been set.

Button operation

[1]

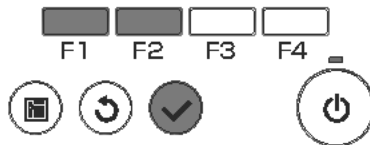
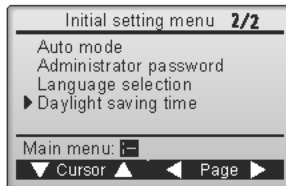

Select "Initial setting" from the Main menu (refer to D-15), and press the button.



Move the cursor to the "Daylight saving time" with the [F1] or [F2] button, and press the button.

[2]

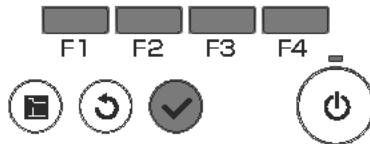
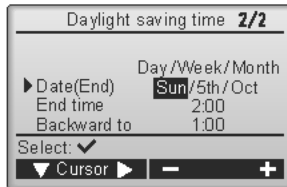
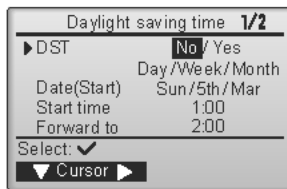

Move the cursor to the following items with the **[F1]** button to make the settings.

- DST
Select "No" (disable) or "Yes" (enable) with the **[F2]** button. The default setting is "No."
- Date(Start)*1
Set the day of the week, week number, and month with the **[F3]** or **[F4]** button. The default setting is "Sun/5th/Mar."
- Start time
Set the start time for daylight saving time with the **[F3]** or **[F4]** button.
- Forward to
Set the time when the clock is to be set forward to at the start time above with the **[F3]** or **[F4]** button.
- Date(End)*1 (2nd page)
Set the day of the week, week number, and month with the **[F3]** or **[F4]** button. The default setting is "Sun/5th/Oct."
- End time (2nd page)
Set the end time for daylight saving time with the **[F3]** or **[F4]** button.
- Backward to (2nd page)
Set the time when the clock is to be set backward to at the end time above with the **[F3]** or **[F4]** button.

*1 If "5th" is selected for the week number and the 5th week does not exist in the selected month of the year, the setting is considered to be "4th."

Press the **[SELECT]** button to save the settings.
A confirmation screen will appear.

Navigating through the screens

- To go back to the Main menu **[MENU]** button
- To return to the previous screen **[RETURN]** button

IX. Service

1. Service menu



Maintenance password is required

Button operation

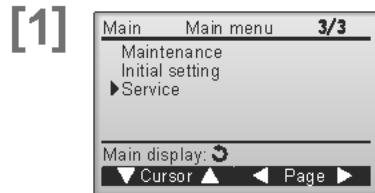

Select "Service" from the Main menu (refer to D-15), and press the button.

*At the main display, the menu button and select "Service" to make the maintenance setting.



When the Service menu is selected, a window will appear asking for the password.

To enter the current maintenance password (4 numerical digits), move the cursor to the digit you want to change with the **[F1]** or **[F2]** button.

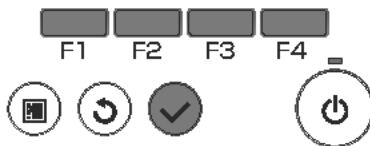

Set each number (0 through 9) with the **[F3]** or **[F4]** button.

Then, press the button.

note: The initial maintenance password is "9999." Change the default password as necessary to prevent unauthorized access. Have the password available for those who need it.

: If you forget your maintenance password, you can initialize the password to the default password "9999" by pressing and holding the **[F1]** and **[F2]** buttons simultaneously for three seconds on the maintenance password setting screen.

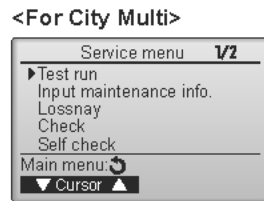
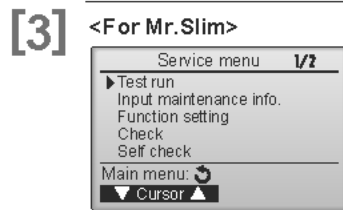

If the password matches, the Service menu will appear.

The type of menu that appears depends on the connected indoor units' type (City Multi or Mr. Slim).

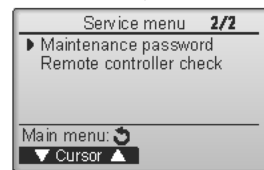
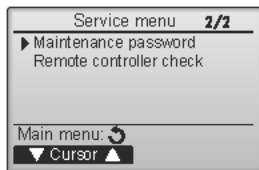

note: Air conditioning units may need to be stopped to make certain settings. There may be some settings that cannot be made when the system is centrally controlled.



A screen will appear that indicates the setting has been saved.

Navigating through the screens

- To go back to the Service menu button
- To return to the previous screen..... button

IX. SERVICE (PAR-33MAA) M/A REMOTE CONTROLLER

2. Test run



Refer to the indoor unit Installation Manual for how to make the settings.

Button operation

[1]

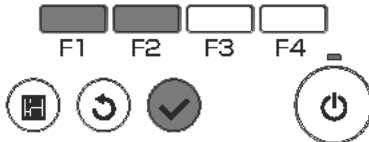

Select "Service" from the Main menu (refer to D-15), and press the button.



Select "Test run" with the or button, and press the button.

[2]

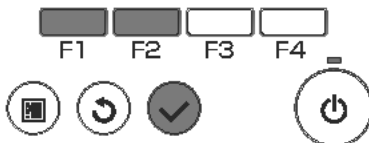
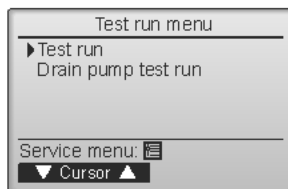

Select "Test run" with the or button, and press the button.

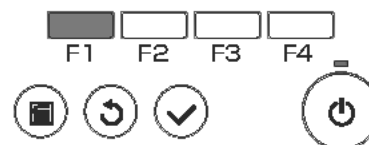
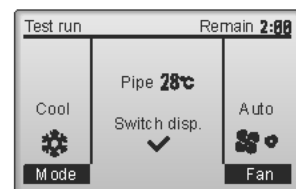

Test run operation

Press the button to go through the operation modes in the order of "Cool and Heat".

Cool mode: Check the cold air blow off.

Heat mode: Check the heat blow off.



Press the button and open the Vane setting screen.

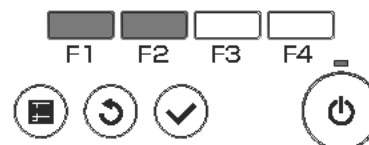
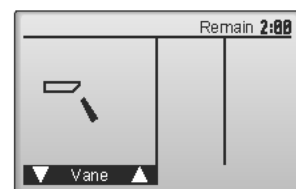

Auto vane check

Check the auto vane with the buttons.

* Check the operation of the outdoor unit's fan.



Press the button to return to "Test run operation".



Press the button.

When the test run is completed, the "Test run menu" screen will appear.

* The test run will automatically stop after two hours.

3. Drain pump test run



It is possible to run just the drain pump without running the indoor unit's fan.
Carry this out after completing the indoor and outdoor electrical work.

* Refer to the indoor unit's installation manual, and confirm that the water is accurately drained, and that no water is leaking from the pipe connections.

Button operation

[1]

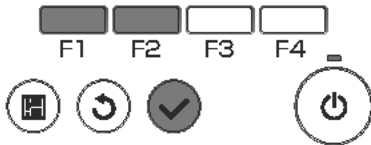

Select "Service" from the Main menu (refer to D-15), and press the button.



Select "Test run" with the or button, and press the button.

[2]

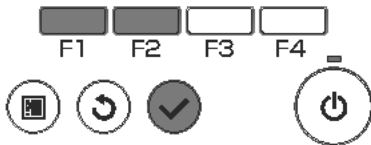
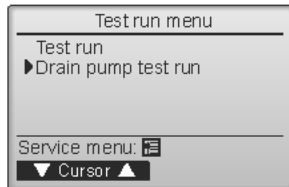

Select "Drain pump test run" with the or button, and press the button.

[3]

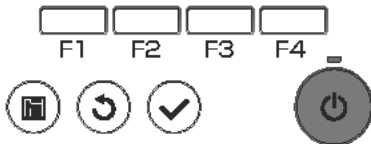
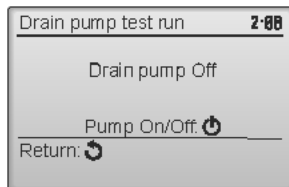

Start the drain pump test run.

Press the button.

* The drain pump will be prepared for the "Drain pump test run", and the test run will start.

[4]

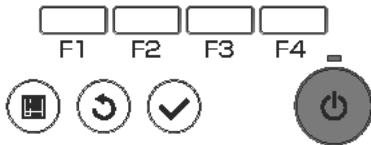
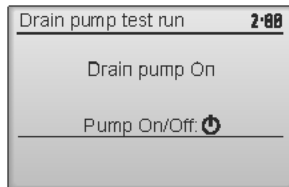

Check the drain pump's operation state.

End the drain pump test run.

Press the button.

The drain pump test run will be finished, and then the "Test run menu" screen will appear.

* The drain pump test run will automatically stop after two hours.

4. Input maintenance Info.



Select "Input maintenance Info." from the Service menu to bring up the Maintenance information screen. Refer to the indoor unit Installation Manual for how to make the settings.

Button operation

[1]

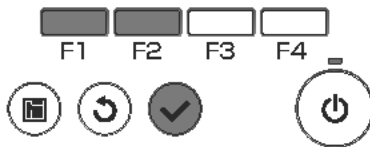
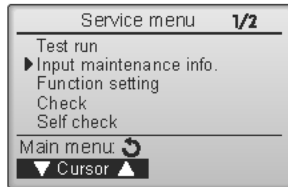

Select "Service" from the Main menu (refer to D-15), and press the button.



Select "Input maintenance info." with the **F1** or **F2** button, and press the button.

4.1. Model name input

[2]

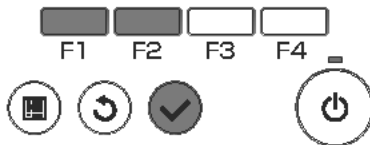
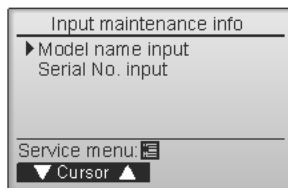

Select "Model name input" with the **F1** or **F2** button, and press the button.

[3]

<For Mr.Slim>

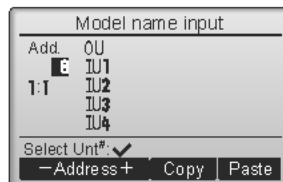

<For City Multi>

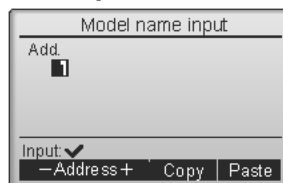

Select the Ref. address, Outdoor unit and Indoor unit to be registered.

Select the Ref address/M-NET address to be registered with the **F1** and **F2** buttons.

<For Mr.Slim>

"Refrigerant address" setting [0] to [15]

<For City Multi>

"M-NET address" setting [1] to [255]

*Only a connected address can be selected.



Press the button.

The registered model information can be copied and pasted into the refrigerant address/M-NET address units.

- **F3** button: Copies the model information for the selected address.
- **F4** button: Overwrites the copied model information onto the selected address.

[4] <For Mr.Slim>

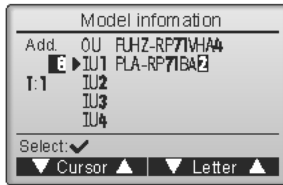

<For City Multi>

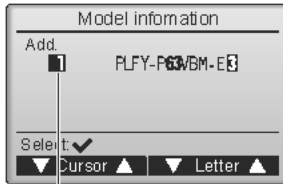

Cursor
The highlighted characters are selected.

Model name input.

Select the unit to be registered with the **F1** and **F2** buttons.

<For Mr.Slim>

- Setting the "Registered unit" [OU] / [IU1] to [IU4]
 - OU: Outdoor unit
 - IU1: Indoor unit No. 1
 - IU2: Indoor unit No. 2
 - IU3: Indoor unit No. 3
 - IU4: Indoor unit No. 4
- * IU2 to IU4 may not appear depending on the type of connected air conditioner (single, twin, triple, quadruple).

Move the input cursor to the left and right with the **F1** and **F2** buttons, and select the letters with the **F3** and **F4** buttons.

■ Input letters
Select from: A, B, C, D ... Z, 0, 1 2 ... 9, -, space
*Model names can be input up to 18 letters.

Press the button.

- Repeat the above step, and register the model names for the outdoor unit and indoor unit of the selected refrigerant address and M-NET address.
- Changing the refrigerant address and M-NET address
After the model name is registered above, press the button. The "3" screen will appear. Change the refrigerant address and M-NET address, and using the previous procedure input the Model name.

4.2. Serial No. input

[5] <For Mr.Slim>

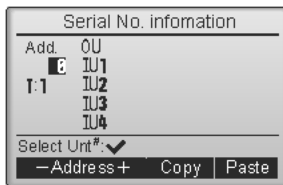

<For City Multi>

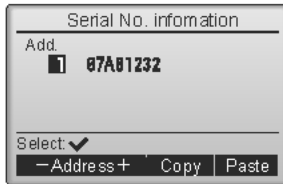

Select "Serial No. input" on the Maintenance information screen, and press the button.

Register the Serial No. with the procedure given in [3] [4].
*Serial No. can be input up to 8 letters.

X. SERVICE (PAR-33MAA)

M/A REMOTE CONTROLLER

Dealer information input

[6]

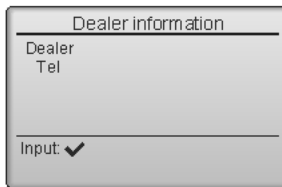

Select "Dealer information input" on the Maintenance information, and press the button.



The current settings will appear. Then press the button again.

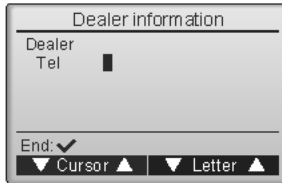

Move the input cursor to the left and right with the **F1** and **F2** buttons, and select the letters with **F3** and **F4** buttons.

■ **Input letters**

Select from : 0 , 1 , 2 , ... , 9 , - , space

*Dealer information can be input up to 13 letters.



Press the button.

Initialize maintenance info.

[7]

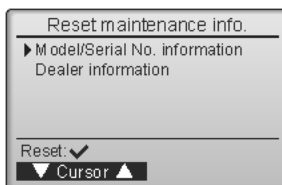

Model/Serial No. information reset.

Select "Initialize maintenance info." on the Maintenance information, and press the button.



Select "Model/Serial No. information" and press the button.

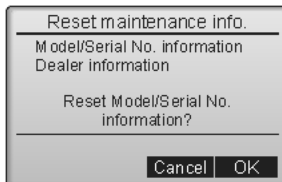



A confirmation screen will appear asking if you want to reset the Model/Serial No. information.



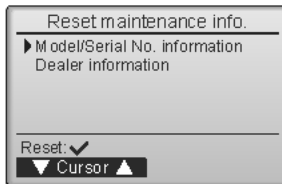

Press the **F4** button (OK) to reset the Model/Serial No information.

[8]

Dealer information reset.

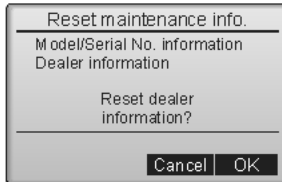
Select "Initialize maintenance info." on the Maintenance information, and press the  button.



Select "Dealer information" and press the  button.



A confirmation screen will appear asking if you want to reset the Dealer information.



Press the  button (OK) to reset the Dealer information.

5. Function Setting



5.1. Mr.Slim

Button operation

[1]

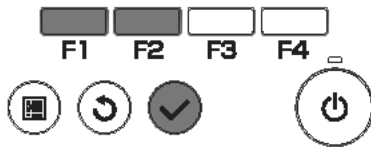
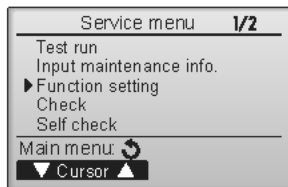

Select "Service" from the Main menu (refer to D-15), and press the button.



Select "Function setting" with the or button, and press the button.

[2]

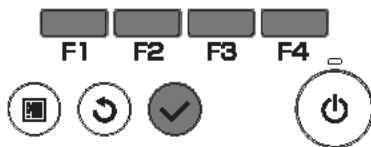
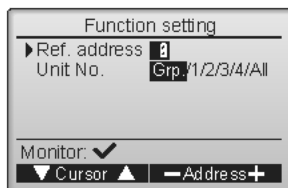

Set the indoor unit refrigerant addresses and unit numbers with the through buttons, and then press the button to confirm the current setting.

<Checking the indoor unit No.>

When the button is pressed, the target indoor unit will start fan operation. If the unit is common or when running all units, all indoor units for the selected refrigerant address will start fan operation.

Make the settings for the indoor unit functions via the remote controller as necessary. Select "Function setting" from the Service menu to bring up the Function setting screen.

[3]

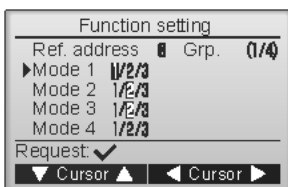

When data collection from the indoor units is completed, the current settings appears highlighted. Non-highlighted items indicate that no function settings are made. Screen appearance varies depending on the "Unit No." setting.

[4]

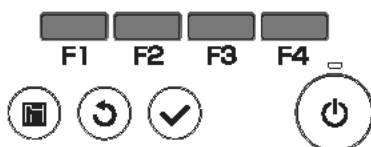
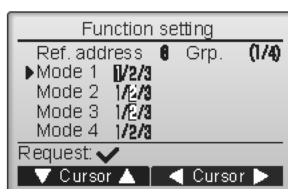

Use the or button to move the cursor to select the mode number, and change the setting number with the or button.

[5]

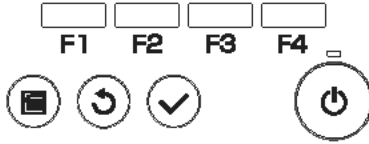
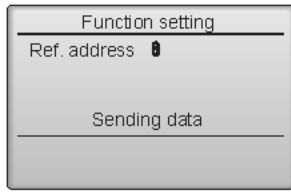

When the settings are completed, press the button to send the setting data from the remote controller to the indoor units.

When the transmission is successfully completed, the screen will return to the Function setting screen.

note:

- Make the above settings only on Mr. Slim units as necessary.
- The above function settings are not available for the City Multi units.
- Table 1 summarizes the setting options for each mode number. Refer to the indoor unit Installation Manual for the detailed information about initial settings, mode numbers, and setting numbers for the indoor units.
- Be sure to write down the settings for all functions if any of the initial settings has been changed after the completion of installation work.

<Table1> Function setting options

Mode No.	Mode	Settings	Setting No.	Unit numbers
01	Automatic recovery after power failure	Disable	1	Set "Grp." for the Unit number. These settings apply to all the connected indoor units.
		Enable (Four minutes of standby time is required after the restoration of power.)	2	
02	Thermistor selection (indoor temperature detection)	Average temperature reading of the indoor units in operation	1	
		Thermistor on the indoor unit to which the remote controller is connected (fixed)	2	
		Built-in sensor on the remote controller	3	
03	LOSSNAY connection	Not connected	1	
		Connected (without outdoor air intake by the indoor units)	2	
		Connected (with outdoor air intake by the indoor units)	3	
04	Power voltage	240 V	1	
		220 V, 230 V	2	
05	AUTO mode	Enable (Automatically the unit achieves effective energy saving operation.)	1	
		Disable	2	
07	Filter sign	100 hours	1	Set "1, 2, 3, 4, or All" for the Unit number. These settings apply to each indoor unit. • If "1, 2, 3, or 4" is set for the Unit number, the settings apply only to the specified indoor unit regardless of the number of connected indoor units (one through four units). • If "ALL" is set for the Unit number, the settings apply to all the connected indoor units regardless of the number of connected indoor units (one through four units).
		2500 hours	2	
		Not displayed	3	
08	Fan speed	Silent mode (or standard)	1	
		Standard (or High ceiling 1)	2	
		High ceiling (or High ceiling 2)	3	
09	Outlet	4 directional	1	
		3 directional	2	
		2 directional	3	
10	Optional parts (High-efficiency filter)	No	1	
		Yes	2	
11	Vane	No vanes (or the vane setting No.3 is effective.)	1	
		Equipped with vanes (The vane setting No.1 is effective.)	2	
		Equipped with vanes (The vane setting No.2 is effective.)	3	

X. SERVICE (PAR-33MAA)

MA REMOTE CONTROLLER

5.2. City Multi

Button operation

[1]

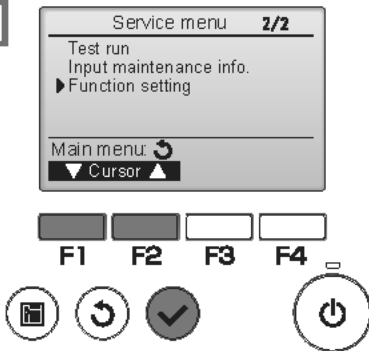

Select "Service" from the Main menu (refer to D-15), and press the button.



Select "Function setting" with the or button, and press the button.

[2]

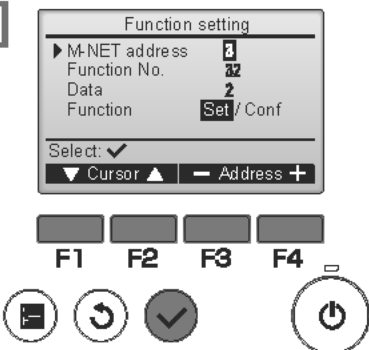

The Function Setting screen will appear.

Press the or button to move the cursor to one of the following: M-NET address, function setting number, or setting value.



Then, press the or button to change the settings to the desired settings.



Once the settings have been completed, press the button.

A screen will appear that indicates that the settings information is being sent.

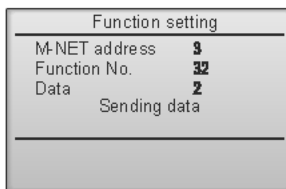

To check the current settings of a given unit, enter the setting for its M-NET address and function setting number, select Conf for the Function, and press the button.

A screen will appear that indicates that the settings are being searched for. When the search is done, the current settings will appear.

[3]

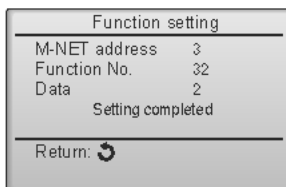

When the settings information has been sent, a screen will appear that indicates its completion.

To make additional settings, press the button to return to the screen shown in Step 3 above. Set the function numbers for other indoor units by following the same steps.

Navigating through the screens

- To return to the Service Menu screen button
- To return to the previous screen button

6. LOSSNAY setting (City Multi)



This setting is required only when the operation of City Multi units is interlocked with LOSSNAY units. This setting is not available for the Mr. Slim units. Interlock settings can be made for the indoor unit to which the remote controller is connected. (They can also be confirmed or deleted.)

- note:**
- Use the centralized controller to make the settings if it is connected.
 - To interlock the operation of the indoor units with the LOSSNAY units, be sure to interlock the addresses of ALL indoor units in the group and that of the LOSSNAY unit.

Button operation

[1]

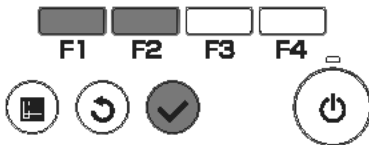
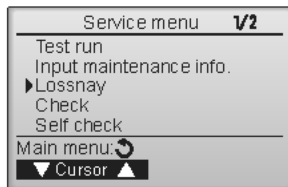

Select "Service" from the Main menu (refer to D-15), and press the button.



Select "Lossnay" with the **F1** or **F2** button, and press the button.

[2]

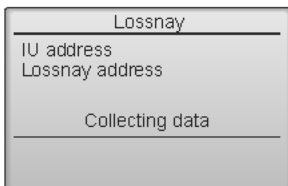

When "Lossnay" on the Service menu is selected, the remote controller will automatically begin searching for the registered LOSSNAY addresses of the currently connected indoor unit.

[3]

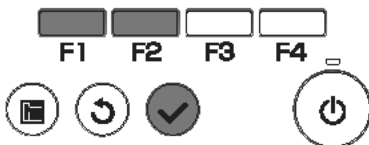
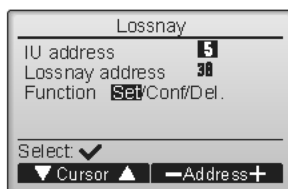

When the search is completed, the smallest address of the indoor units that are connected to the remote controller and the address of the interlocked LOSSNAY unit will appear. "--" will appear if no LOSSNAY unit is interlocked with the indoor units.

If no settings need to be made, press the button to go back to the Service menu.

X. SERVICE (PAR-33MAA)

M/A REMOTE CONTROLLER

[4]

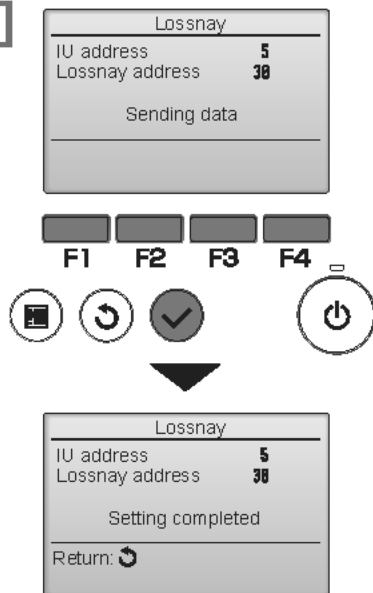
**To make LOSSNAY interlock setting**

Enter the addresses of the indoor unit and the LOSSNAY unit to be interlocked, with the [F1] through [F4] buttons, select "Set" in the "Function", and press the  button to save the settings.

"Sending data" will appear on the screen.

If the setting is successfully completed, "Setting completed" will appear.

[5]

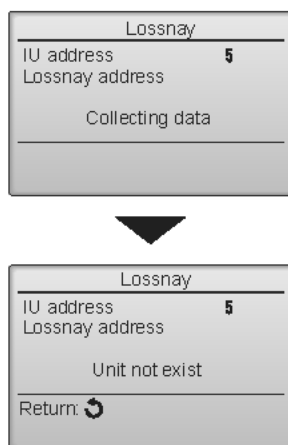
**To search for the LOSSNAY address**

Enter the address of the indoor unit to which the remote controller is connected, select "Conf" in the "Function", and press the  button.

"Collecting data" will appear on the screen. If the signal is received correctly, the indoor unit address and LOSSNAY address will appear. "--" will appear when no LOSSNAY unit is found. "Unit not exist" will appear if no indoor units that are correspond to the entered address are found.

[6]

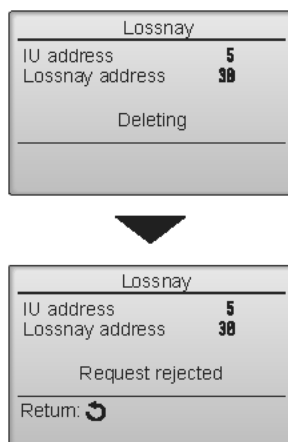
**To delete the interlock setting**

To delete the interlocked setting between LOSSNAY unit and the indoor units to which the remote controller is connected, enter the indoor unit address and LOSSNAY address with the [F1] through [F4] buttons, select "Del." in the "Function", and press the  button. "Deleting" will appear.

The screen will return to the search result screen if the deletion is successfully completed. "Unit not exist" will appear if no indoor units that are correspond to the entered address are found. If deletion fails, "Request rejected" will appear on the screen.



7. Check

7.1. Error history

Button operation

[1]

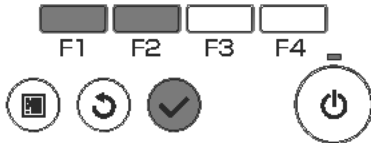

Select "Service" from the Main menu (refer to D-15), and press the button.



Select "Check" with the **F1** or **F2** button, and press the button.

[2]

<For Mr.Slim>

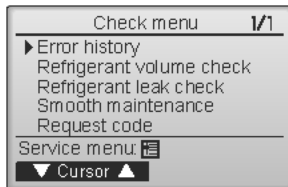

<For City Multi>

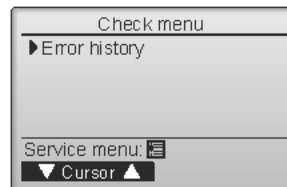

Select "Error history" with the **F1** or **F2** button, and press the button.

[3]

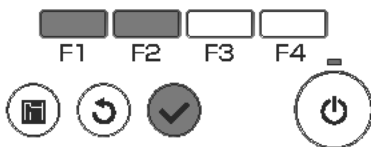
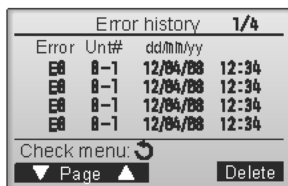

Error history

Select "Error history" from the Check menu, and press the button to view up to 16 error history records.

Four records are shown per page, and the top record on the first page indicates the latest error record.

[4]

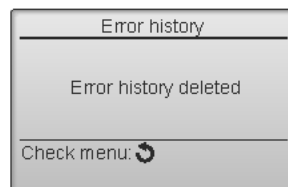
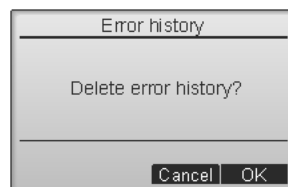

Deleting the error history

To delete the error history, press the **F4** button (Delete) on the screen that shows error history.

A confirmation screen will appear asking if you want to delete the error history.



Press the **F4** button (OK) to delete the history.



"Error history deleted" will appear on the screen.

Press the button to go back to the Check menu screen.

7. Check



7.2. Refrigerant leak check

Refrigerant leakage is detected after a long time.

To enable this function, the refrigerant volume must be saved (initial learning) after installation. Always operate this function in the following manner after installation.

- Always perform test run before using this function, and confirm that the air conditioner operates normally.
- To accurately detect refrigerant leaks, set the wind speed to strong, and execute this operation.

* "Refrigerant leak check" is valid only with models which support the refrigerant leak check function.

Button operation

[1]

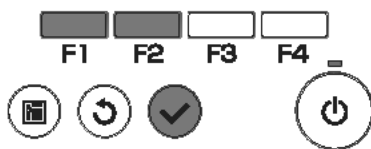
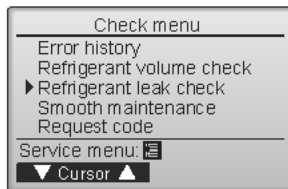

Select "Service" from the Main menu (refer to D-15), and press the button.



Select "Check" with the or button, and press the button.



Select "Refrigerant leak check" with the or button, and press the button.

[2]

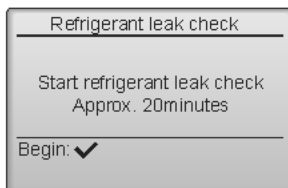

Stable mode will start.

Press the button, stable mode will start.

*Stable mode will take approx. 20 minutes.

[3]

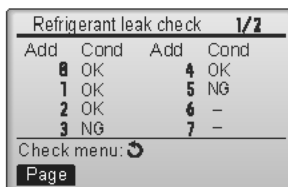

The operation data will appear.

The following value is the reference for the refrigerant volume check. If the refrigerant is leaking, "NG" will appear.

The refrigerant volume check reference value can be changed with the function selection.

Default value (Z)RP71 - : 80%
- (Z)RP50 : 70%

<Resetting the initial learning data>

If the unit has been relocated or if refrigerant has been additionally charged, the initial learning data must be reset and learning performed again.

How to reset the data:

1. Turn the main power OFF.
2. Attach the short-circuit pin for the emergency operation connector (CN31) on the outdoor controller board to the ON side.
3. Turn ON the test run switch (SW4-1) on the outdoor controller board.
4. The data will be reset when the main power is turned ON.
5. Turn the main power OFF.
6. Turn OFF the test run switch (SW4-1).
7. Return the short-circuit pin for the emergency operation connector (CN31) to the OFF side.

* Under the following conditions, it may not be possible to carry out stable operation or accurately detect refrigerant leaks.

- When the outdoor intake temperature is 40°C or higher, or when the indoor intake temperature is 23°C or less.
- When the indoor fan speed is not set to strong.



7. Check

7.3. Smooth maintenance

Maintenance data, such as the indoor/outdoor unit's heat exchanger temperature and compressor operation current can be displayed with "Smooth maintenance".

* This cannot be executed during test operation.

* Depending on the combination with the outdoor unit, this may not be supported by some models.

Button operation

[1]

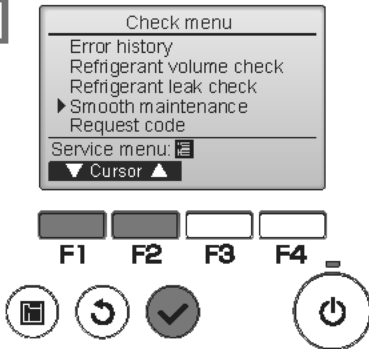

Select "Service" from the Main menu (refer to D-15), and press the button.

Select "Check" with the or button, and press the button.

Select "Smooth maintenance" with the or button, and press the button.

[2]

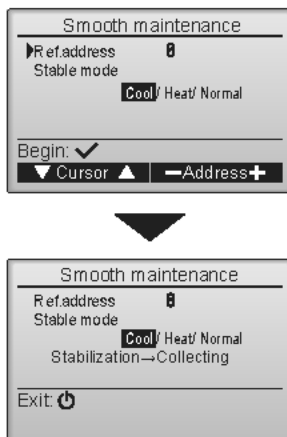

Set each item.

Select the item to be changed with the or button.

Select the required setting with the or button.

- <Ref.address>setting [0] - [15]
- <Stable mode>setting [Cool] / [Heat] / [Normal]

Press the button, Fixed operation will start.

* Stable mode will take approx. 20 minutes.

[3]

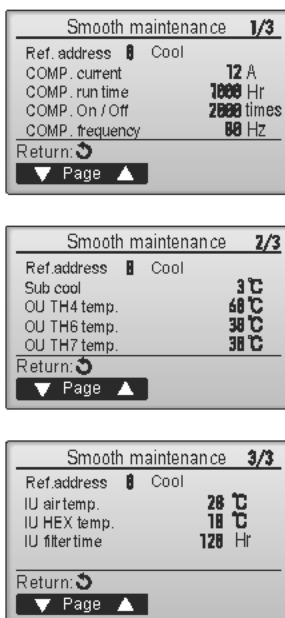

The operation data will appear.

The Compressor-Accumulated operating (COMP. run) time is 10-hour unit, and the Compressor-Number of operation times (COMP. On / Off) is a 100-time unit (fractions discarded).

Navigating through the screens

- To go back to the Service menu
- To return to the previous screen



7. Check

7.4. Request code

Details on the operation data including each thermistor temperature and error history can be confirmed with the remote controller.

Button operation

[1]

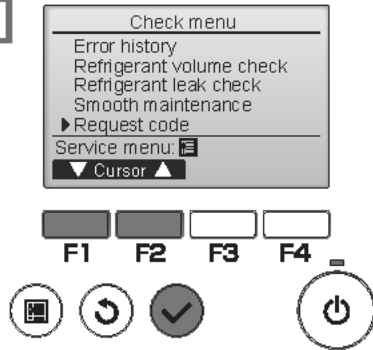

Select "Service" from the Main menu (refer to D-15), and press the button.

Select "Check" with the or button, and press the .

Select "Request code" with the or button, and press the .

[2]

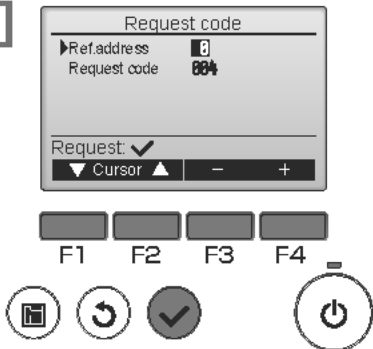

Set the Refrigerant address and Request code.

Select the item to be changed with the or button.

Select the required setting with the or button.

- <Ref.address>setting [0] - [15]
- <Request code>setting [Refer to next page]

Press the , Data will be collected and displayed.

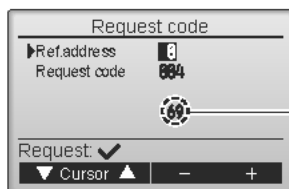

Request code: 004
Discharge temperature: 69°C

<Operation state> (Request code "0")

Data display



Operation mode

Relay output state

1) Operation mode

Display	Operation mode
0	STOP • FAN
C	COOL • DRY
H	HEAT
d	Defrost

2) Relay output state

Display	Power currently supplied to compressor	Compressor	Four-way valve	Solenoid valve
0	—	—	—	—
1				ON
2			ON	
3			ON	ON
4		ON		
5		ON		ON
6		ON	ON	
7		ON	ON	ON
8	ON			
A	ON		ON	

<Request Cord list>

* The Request code 150 – 152 data is the information for the indoor unit to which the remote controller is connected.

Request code	Request content	Description (Display range)	Unit	Remarks
0	Operation state	Refer to "Operation mode"	–	
1	Compressor - Operating current (rms)	0 – 50	A	
2	Compressor - Accumulated operating time	0 – 9999	10 hours	
3	Compressor - Number of operation times	0 – 9999	100 times	
4	Discharge temperature (TH4)	3 – 217	°C	
5	Outdoor unit - Liquid pipe 1 temperature (TH3)	-40 – 90	°C	
7	Outdoor unit - 2 phase pipe temperature (TH6)	-39 – 88	°C	
9	Outdoor unit - Outside air temperature (TH7)	-39 – 88	°C	
10	Outdoor unit - Heatsink temperature (TH8)	-40 – 200	°C	
12	Discharge superheat (SHd)	0 – 255	°C	
13	Sub - cool (SC)	0 – 130	°C	
16	Compressor - Operating frequency	0 – 255	Hz	
18	Outdoor unit - Fan output step	0 – 10	Step	
22	LEV (A) opening	0 – 500	Pulses	
30	Indoor unit - Setting temperature	17 – 30	°C	
31	Indoor unit - Intake air temperature <Measured by thermostat>	8 – 39	°C	
37	Indoor unit - Liquid pipe temperature (Unit No.1)	-39 – 88	°C	"0" is displayed if the target unit is not present
38	Indoor unit - Liquid pipe temperature (Unit No.2)	-39 – 88	°C	
39	Indoor unit - Liquid pipe temperature (Unit No.3)	-39 – 88	°C	
40	Indoor unit - Liquid pipe temperature (Unit No.4)	-39 – 88	°C	
42	Indoor unit - Cond./Eva. pipe temperature (Unit No.1)	-39 – 88	°C	
43	Indoor unit - Cond./Eva. pipe temperature (Unit No.2)	-39 – 88	°C	
44	Indoor unit - Cond./Eva. pipe temperature (Unit No.3)	-39 – 88	°C	
45	Indoor unit - Cond./Eva. pipe temperature (Unit No.4)	-39 – 88	°C	
100	Outdoor unit - Error postponement history 1 (latest)	Displays postponement code ("–" is displayed if no postponement code is present)	Code	
103	Error history 1 (latest)	Displays error history ("–" is displayed if no history is present)	Code	
104	Error history 2 (Second to last)	Displays error history ("–" is displayed if no history is present)	Code	
107	Operation mode at time of error	Displayed in the same way as request code "0"	–	
150	Indoor - Actual intake air temperature	-39 – 88	°C	
151	Indoor - Liquid pipe temperature	-39 – 88	°C	
152	Indoor - 2 phase pipe temperature	-39 – 88	°C	

8. Self check



Button operation

[1]

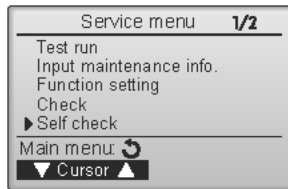

Select "Service" from the Main menu (refer to D-15), and press the button.



Select "Self check" with the **F1** or **F2** button, and press the button.

[2]

<For Mr.Slim>



<For City Multi>



With the **F1** or **F2** button, enter the refrigerant address (Mr. Slim) or the M-NET address (City Multi), and press the button.

[3]

<For Mr.Slim>

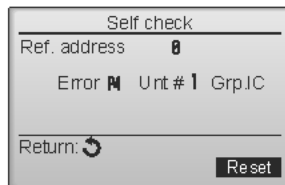

<For City Multi>

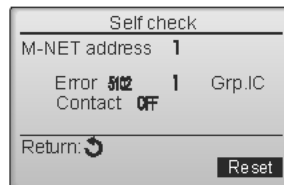

Error code, unit number, attribute, and indoor unit demand signal ON / OFF status at the contact (City Multi only) will appear. "-" will appear if no error history is available.

When there is no error history

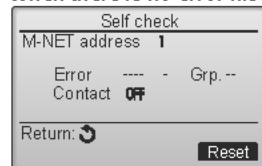

[4]

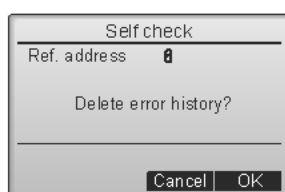

Resetting the error history.

Press the **F4** button (Reset) on the screen that shows the error history.



A confirmation screen will appear asking if you want to delete the error history.



Press the **F4** button (OK) to delete the error history.

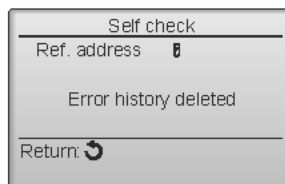

If deletion fails, "Request rejected" will appear.

"Unit not exist" will appear if no indoor units that are correspond to the entered address are found.

Navigating through the screens

- To go back to the Service menu button
- To return to the previous screen button

9. Maintenance password



Button operation

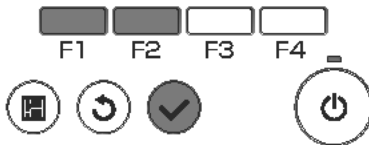
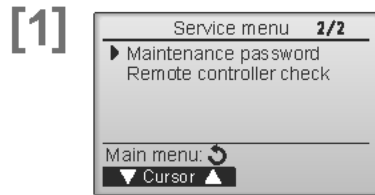

Select "Service" from the Main menu (refer to D-15), and press the [check] button.



Select "maintenance password" with the [F1] or [F2] button, and press the [check] button.

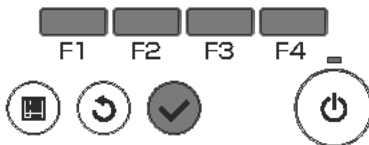
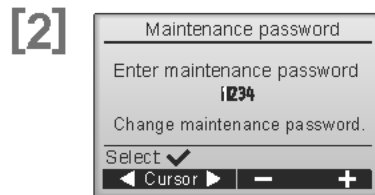

Move the cursor to the digit you want to change with the [F1] or [F2] button, and set each digit to the desired number (0 through 9) with the [F3] or [F4] button.



Press the [check] button to save the new password.

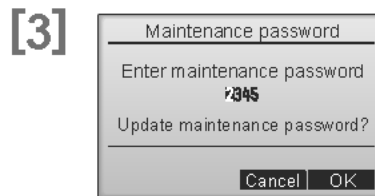

A confirmation screen will appear asking if you want to change the maintenance password.



Press the [F4] button (OK) to save the change.



Press the [F3] button (Cancel) to cancel the change.

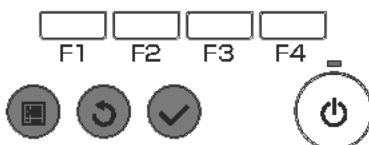

"Changes saved" will appear when the password is updated.

Press the [back] button to return to the Service menu or press the [refresh] button to go back to the "Maintenance password" screen.

note: The default maintenance password is "9999". Change this password if necessary so that settings cannot be changed by persons other than the administrator. Store the password where it can be accessed if necessary.

Navigating through the screens

- To go back to the Service menu [back] button
- To return to the previous screen [refresh] button

X. SERVICE (PAR-33MAA)

MA REMOTE CONTROLLER

10. Remote controller check



If operations cannot be completed with the remote controller, diagnose the remote controller with this function.

Button operation

[1]

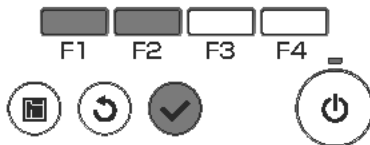
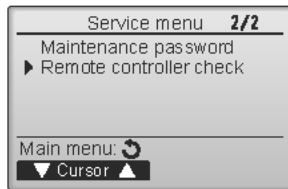

Select "Service" from the Main menu (refer to D-15), and press the button.

Select "Remote controller check" with the or button, and press the button.

[2]

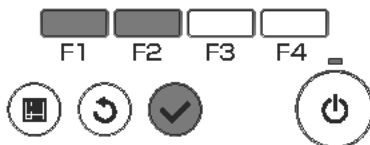
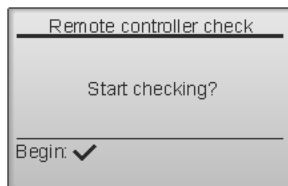

Select "Remote controller check" from the Service menu, and press the button to start the remote controller check and see the check results.

To cancel the remote controller check and exit the Remote controller check menu screen, press the or the button.

The remote controller will not reboot itself.

[3] Remote controller check results screen

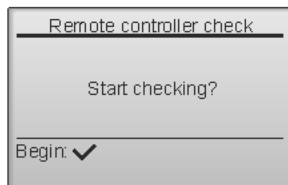

OK: No problems are found with the remote controller. Check other parts for problems.

E3, 6832: There is noise on the transmission line, or the indoor unit or another remote controller is faulty. Check the transmission line and the other remote controllers.

NG (ALLO, ALL1): Send-receive circuit fault. Remote controller needs replacing.

ERC: The number of data errors is the discrepancy between the number of bits in the data transmitted from the remote controller and that of the data that was actually transmitted over the transmission line. If data errors are found, check the transmission line for external noise interference.

If the button is pressed after the remote controller check results are displayed, remote controller check will end, and the remote controller will automatically reboot itself.

Check the remote controller display and see if anything is displayed (including lines). Nothing will appear on the remote controller display if the correct voltage (8.5 – 12 VDC) is not supplied to the remote controller. If this is the case, check the remote controller wiring and indoor units.

X. Specifications · Outline Dimensions

1. Specifications

<Specifications>

Product size	120(W) × 120(H) × 19(D) mm (4 3/4 × 4 3/4 × 3/4 [in] (not including the protruding part)	
Net weight	0.25kg (9/16lb.)	
Rated power supply voltage	12V DC (supplied from indoor units)	
Power consumption	0.3W	
Usage environment	Temperature	0 – 40°C (32 - 104°F)
	Humidity	30 – 90%RH (with no dew condensation)
Material	Panel	PMMA
	Main body	PC + ABS
Sound Pressure Level	The A-weighted sound pressure level is below 70 dB.	

<Connection model>

Unit controlled
Mr.Slim Air conditioners Indoor unit (A controlled)
Multi air conditioners Indoor unit
Multi air conditioners LOSSNAY *1

This manual explains the methods of connecting to the Mr.slim air conditioner.

*1.Connecting via an indoor unit (Direct connection not possible)

2. Outline Dimensions

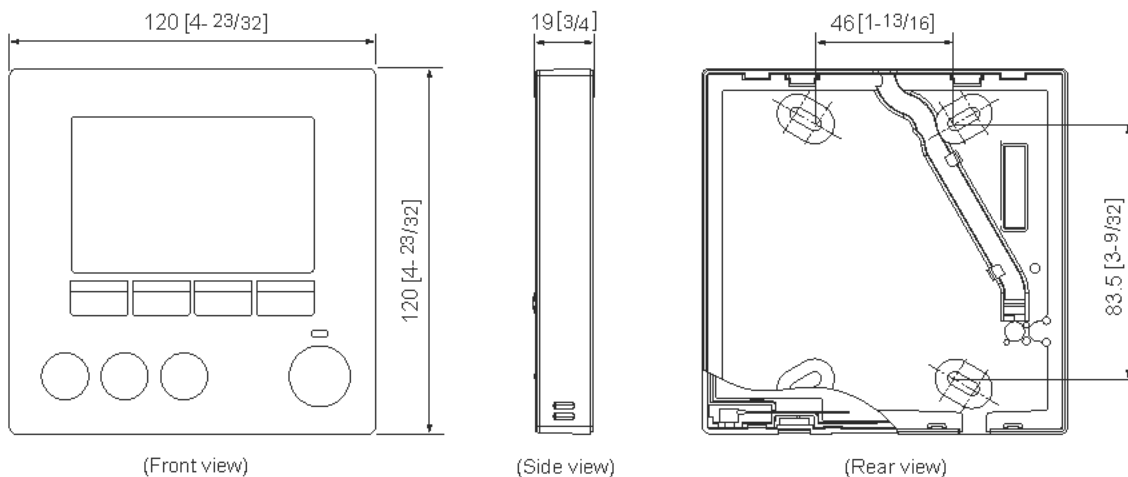

Unit : mm [in.]

X. SPECIFICATIONS · OUTLINE DIMENSIONS (PAR-33MAA)

MA
REMOTE
CONTROLLER

MA Remote Controller

Simple MA remote controller [PAC-YT52CRA]

I . Product Feature.....	D-82
II . Functions	D-83
1. Operations/Display.....	D-83
2. Restriction settings	D-83
3. Miscellaneous	D-83
III . Names and functions of controller components	D-84
1. Controller interface.....	D-84
2. Display	D-84
IV . Basic operations	D-85
1. Operation mode	D-85
2. Preset temperature	D-86
3. Fan speed.....	D-87
V . Controller operation-Function settings.....	D-88
1. Temperature range restriction.....	D-88
2. Operation lock setting.....	D-89
3. Mode skip setting.....	D-89
VI . Specifications	D-90

1. Product Feature

New Design

- **Backlit LCD** Backlight for operation in dark place
- **LCD size up**
 20 x 31(mm) [0.78 x 1.22(in)]
 →22 x 37(mm) [0.9 x 1.5(in)]
- **Flat back**
 Install without hole on wall Slim and flat type :
 Thickness is less than 14.5mm [0.6(in)]
- **Vane button (standard)**
 The Vane button has been added to allow the user to change airflow direction (ceiling-cassette and wall-mounted types).



Pressing the  button will switch the vane directions.



* The settable vane direction varies depending on the indoor unit model to be connected.
 * If the unit has no vane function, the vane direction cannot be set.
 In this case, the vane icon blinks when the  button is pressed.

Newly added functions!

New functions have been added to the CITY MULTI series that enable the setting of certain indoor unit functions (such as static pressure) from the remote controller. (For more detailed information, please contact your nearest sales office or distributor.)

System Structure

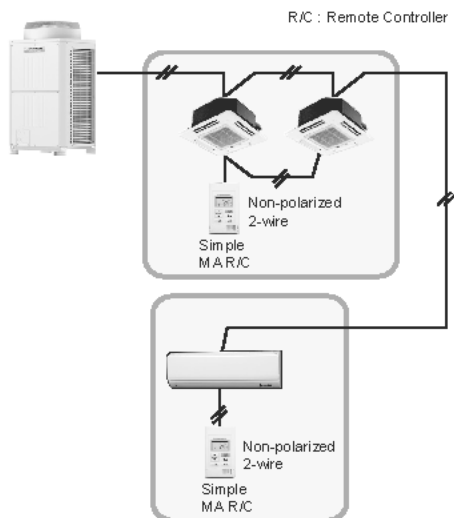

New PAC-YT52CRA

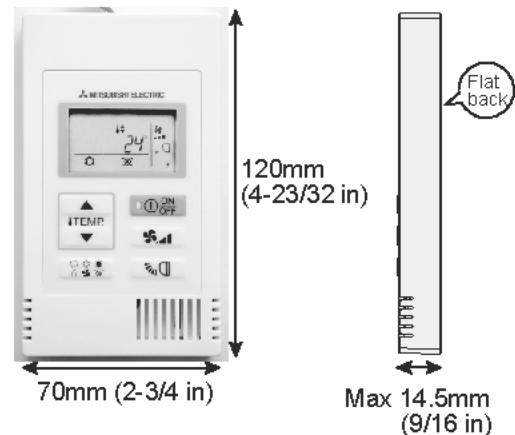

1. Product features [PAC-YT52CRA]

MA REMOTE CONTROLLER

II . Functions

1. Operations/Display

Item	Setting	Display	Description
ON/OFF	✓	✓	Changes between ON and OFF.
Operation mode switching *1	✓	✓	Select from COOL, DRYING, FAN, AUTO, and HEAT.
Room temp. Setting *1	✓	✓	Sets a room temperature. * The preset temperature range varies depending on the indoor unit model to be connected. (The ranges for a standard model are as follows.) • COOL/DRY: 19°C - 30°C/67°F - 87°F • HEAT: 17°C - 28°C/63°F - 83°F • AUTO: 19°C - 28°C/67°F - 83°F
Fan speed setting	✓	✓	Changes the fan speed. * The settable fan speed varies depending on the indoor unit model to be connected.
Vane setting	✓	✓	Switches the vane directions. * The settable vane direction varies depending on the indoor unit model to be connected.
Ventilation equipment control	✓	✓	When the CITY MULTI indoor unit is connected, interlocked setting of the CITY MULTI LOSSNAY unit is possible. When the Mr. SLIM indoor unit (A-control) is connected, interlocked operation of the microcomputer-type LOSSNAY unit is possible.
Backlight	✓	✓	Pressing the button lights up a backlight. The light automatically turns off after a certain period of time. (The brightness settings can be selected from Bright, Dark, and Light off.)
Error information	—	✓	Displays the current error status with the address. * The address may not be displayed depending on the error status.

*1 AUTO mode is settable only when those functions are available on the indoor unit.

2. Restriction settings

Item	Setting	Display	Description
Allows/disallows local operation	—	✓	By setting a centralized controller, the following local operations are prohibited: ON/OFF; operation mode; preset temperature; * The CENTRAL icon appears while the local operations are prohibited.
Operation lock	✓	✓	Locks all buttons.
Temperature range restriction	✓	✓	The preset temperature range can be restricted for each operation mode (COOL/HEAT/AUTO).

3. Miscellaneous

Item	Description
Room temperature detection	The temperature sensor is built-in on the remote controller.
Various settings	The following settings can be made by setting the dip switches. • Remote controller Main/Sub setting • Temperature display unit setting (Celsius/Fahrenheit) • Cooling/heating display in AUTO mode • Indoor temperature display

III . Names and functions of controller components

1.Controller interface

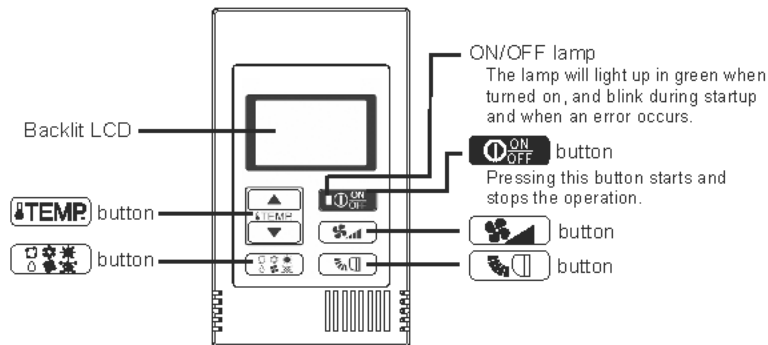

* To set the functions that are not available on this controller (PAC-YT52CRA) such as Louver, use MA remote controller or the centralized controller.

2.Display

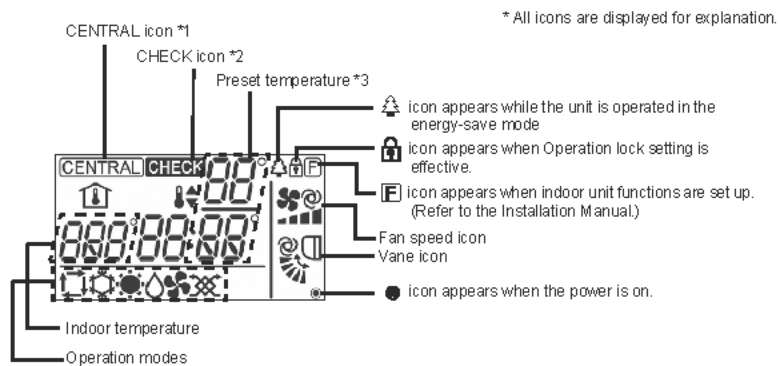

*1 **CENTRAL** icon

Appears when one of the following local operations is prohibited: ON/OFF; operation mode; preset temperature; fan speed; vane.

*2 **CHECK** icon

For Mr. SLIM, when an error occurs, power indicator will blink, and refrigerant address (two digits), error code (two digits), and unit No. will blink.

For City Multi, when an error occurs, power indicator will blink, and unit address (three digits) and error code (four digits) will blink.

Check the error status, stop the operation, and consult your dealer.

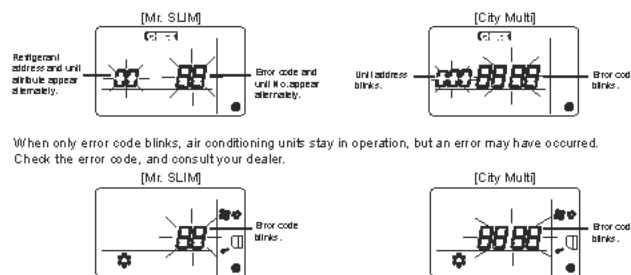

*3 Preset temperature

* Centigrade or Fahrenheit is selectable. Refer to the Installation Manual for details.

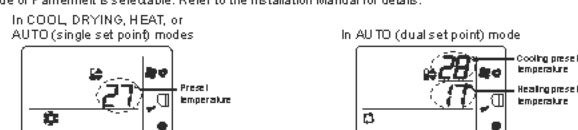

IV. Basic operations

1. Operation mode



Pressing the  button will change the operation mode in the following order.

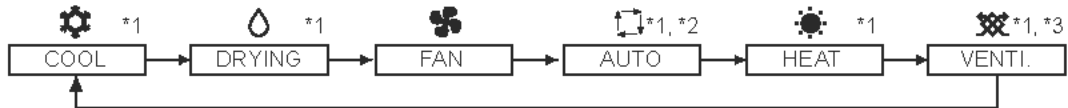

*1: Not all functions are available on all models of indoor units. Functions that are not available will not appear on the display.

*2: The preset temperature for AUTO (either single or dual set point) mode will appear depending on the indoor unit model.

*3: Available only on the Mr. SLIM unit interlocked with LOSSNAY unit.

"VENTI." will light up when LOSSNAY unit operates while the unit is in operation.

AUTO (dual set point) mode:

In AUTO (dual set point) mode, the preset temperatures can be set for cooling and heating, and operation can be switched automatically between cooling and heating depending on the room temperature.

The preset temperatures for cooling and heating set in AUTO (dual set point) mode will be reflected to the temperature setting for COOL/DRYING and HEAT modes.

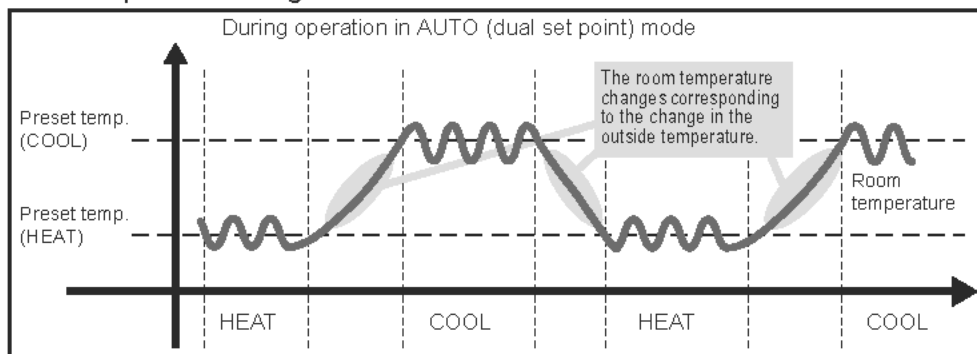

2.Preset temperature



In COOL, DRYING, HEAT, and AUTO (single set point) modes

- Pressing the **TEMP ▲** button increases the preset temperature.
- Pressing the **TEMP ▼** button decreases the preset temperature.

In AUTO (dual set point) mode

Cooling preset temperature

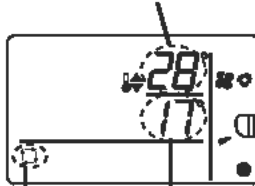

Current preset temperature (cooling/heating) appears.

When the **TEMP ▲** or **TEMP ▼** button is pressed, the preset temperature (cooling/heating) display blinks.

Heating preset temperature

Current operation mode

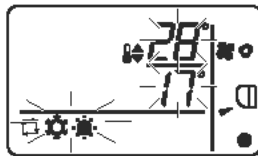

While the preset temperature (cooling/heating) display blinks, pressing the **TEMP ▲** button increases the preset temperatures for both cooling and heating, and pressing the **TEMP ▼** button decreases the preset temperatures for both cooling and heating.

When the **COOL** button is pressed, only the cooling preset temperature display blinks.

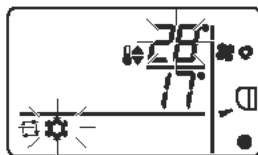

While the cooling preset temperature display blinks, pressing the **TEMP ▲** button increases the cooling preset temperature, and pressing the **TEMP ▼** button decreases the cooling preset temperature.

When the **HEAT** button is pressed, only the heating preset temperature display blinks.

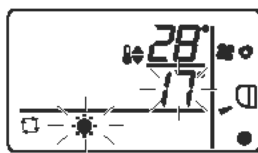

While the heating preset temperature display blinks, pressing the **TEMP ▲** button increases the heating preset temperature, and pressing the **TEMP ▼** button decreases the heating preset temperature.

Pressing the **SET** button completes the preset temperature setting.

- * During the preset temperature setting, the setting will automatically turn off if the **TEMP ▲** or **TEMP ▼** button is left untouched for a certain period of time.

Preset temperature range is as follows.

Operation mode	Preset temperature range
COOL/DRYING	19 - 30°C/67 - 87°F *1
HEAT	17 - 28°C/63 - 83°F *1
AUTO (single set point)	19 - 28°C/67 - 83°F *1
AUTO (dual set point)	[COOL] Preset temperature range for COOL mode. [HEAT] Preset temperature range for HEAT mode. *2, *3
FAN, VENTI.	Unsettable

*1 Preset temperature range varies depending on the indoor unit model to be connected. Refer to the Indoor unit Instruction Book for details.

*2 The preset temperatures for cooling and heating for AUTO (dual set point) mode will be used for those for COOL/DRYING and HEAT mode.

*3 The preset temperatures for cooling and heating can be set under the following conditions.

- The cooling preset temperature is greater than the heating preset temperature.
- The difference between the cooling and heating preset temperatures is equal or greater than the minimum temperature difference that varies depending on the indoor unit model to be connected.

3. Fan speed



Pressing the  button will change the fan speed in the following order.

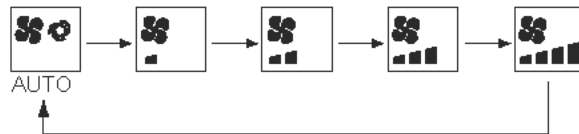

- * The settable fan speed varies depending on the indoor unit model to be connected.
- * If the unit has no fan setting function, the fan speed cannot be set.
In this case, the fan icon blinks when the  button is pressed.

Vane



Pressing the  button will switch the vane directions.



- * The settable vane direction varies depending on the indoor unit model to be connected.
- * If the unit has no vane function, the vane direction cannot be set.
In this case, the vane icon blinks when the  button is pressed.

V. Controller operation-Function settings

1. Temperature range restriction

The preset temperature range for each operation mode can be restricted.

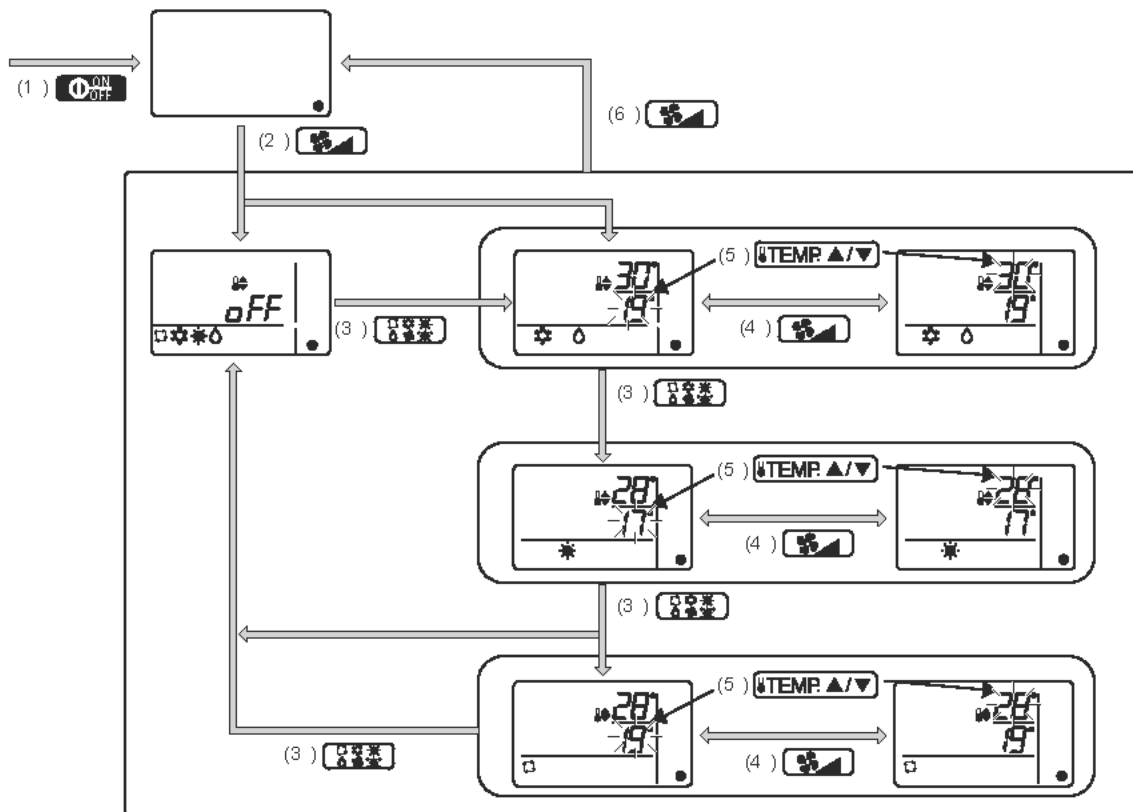

- (1) Press the **ON/OFF** button to stop the air conditioning unit.
- (2) Press and hold the button for three seconds or longer to bring up the temperature range restriction setting display. (A or B appears.)
- (3) Press the button to select from A through D.
* When the AUTO (single set point) mode is not available on the indoor unit, or when the AUTO mode is set to OFF in the Mode skip setting, D will not be displayed.

A. No temperature range restriction:

The temperature range restriction will not be executed for all modes.

B. Temperature range restriction for COOL/DRYING mode:

The preset temperature range for COOL/DRYING and AUTO (dual set point) modes can be changed.

C. Temperature range restriction for HEAT mode:

The preset temperature range for HEAT and AUTO (dual set point) modes can be changed.

D. Temperature range restriction for AUTO (single set point) mode:

The preset temperature range for AUTO (single set point) mode can be changed.

- (4) Press the button to switch between the upper limit (Hi) and lower limit (Lo) settings.

- (5) Press the **TEMP ▲** or **TEMP ▼** button to set upper/lower limit value.
- Pressing the **TEMP ▲** and **TEMP ▼** buttons simultaneously can bring up the previous temperature range of COOL/DRYING, HEAT, and AUTO modes.
 - The temperature can be adjusted within the preset temperature range of the indoor unit. Refer to the Indoor unit Instruction Book for details.
- (6) Press and hold the **🔒** button for three seconds or longer to complete the setting.
- If this action is taken while A is displayed, the temperature range restriction will not be executed.
 - If this action is taken while one of B through D is displayed, all temperature range restrictions for COOL/ DRYING, HEAT, and AUTO modes set in B through D will be executed.
 - If the preset temperature range has not been changed, the restriction will not be executed.
 - After the temperature range restriction is executed, if the user tries to select a temperature outside of the range, the preset temperature display will blink.
- * The temperature range on this controller (PAC-YT52CRA) connected to the indoor units that have the temperature range restriction function can be restricted also from the centralized controller that has the same function.

2.Operation lock setting

This function can lock all buttons.

A. Operation lock is enabled.

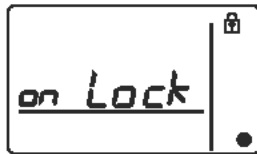

B. While the operation lock is enabled.

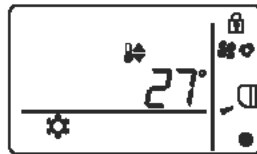

C. Operation lock is disabled.



Locking the operations

While the operation lock is disabled (**🔒** icon is unlit.), press and hold the **🔒** button for three seconds or longer to enable the Operation lock. (A)

* While the operation lock is enabled, **🔒** icon is lit. (B)

* If any button is pressed while the operation lock is enabled, **🔒** icon will blink.

Unlocking the operations

While the operation lock is enabled (**🔒** icon is lit.), press and hold the **🔒** button for three seconds or longer to disable the Operation lock. (C)

3.Mode skip setting



The usability of AUTO mode can be set.

This setting is effective only when the controller is connected to the indoor units that have AUTO mode.

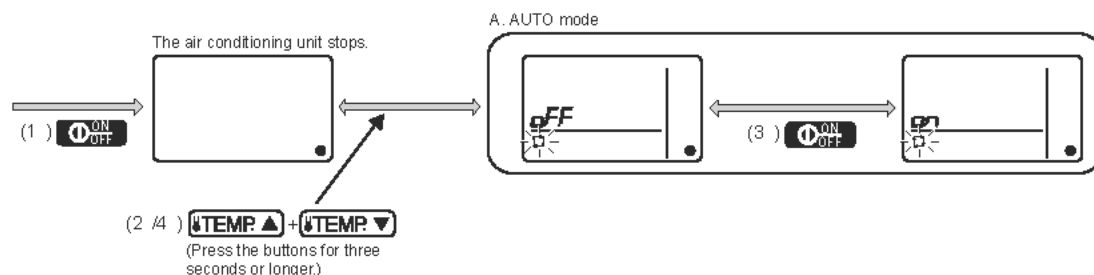

- (1) Press the **ON/OFF** button to stop the air conditioning unit.
- (2) Press the **TEMP ▲** and **TEMP ▼** buttons simultaneously for three seconds or longer to bring up the Mode skip settings display. (The current setting will appear.)
- (3) Press the **ON/OFF** button to select ON or OFF.
 ON: AUTO mode can be selected by pressing the **ON/OFF** button during operation.
 OFF: AUTO mode cannot be selected by pressing the **ON/OFF** button during operation.
- (4) Press the **TEMP ▲** and **TEMP ▼** buttons simultaneously for three seconds or longer to complete the setting.

Backlight brightness setting

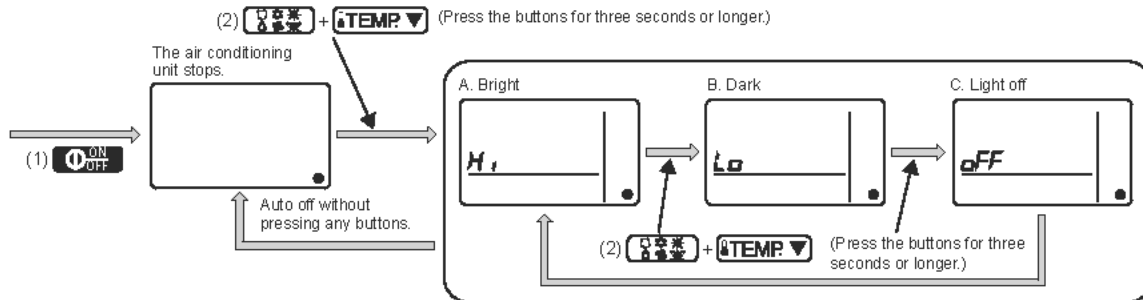

- (1) Press the **ON/OFF** button to stop the air conditioning unit.
- (2) Press the **ON/OFF** and **TEMP ▼** buttons simultaneously for three seconds or longer to change the backlight brightness. (The factory setting is "bright.")
 * Repeat step (2) above to switch the settings A, B, and C.
 * The setting will automatically turn off if step (2) is not performed for a certain period of time.

VI. Specifications

Controller specifications

	Specifications
Product size	70 (W) × 120 (H) × 14.5 (D) mm (2-3/4 × 4-3/4 × 9/16 [in]) (not including the protruding part)
Net weight	0.1 kg (1/4 lb.)
Rated power supply voltage	12 VDC (supplied from indoor units)
Power consumption	0.3 W
Usage environment	Temperature 0 ~ 40°C (32 ~ 104°F) Humidity 30 ~ 90%RH (with no dew condensation)
Material	PC + ABS

VI. Specifications [PAC-VT52CRA]

M/A REMOTE CONTROLLER

Wireless Remote Controller

[PAR-SL100A-E]

I . Safety Precautions.....	D-92
II . Names and functions of controller components	D-93
III . Before Operation	D-94
3.1.Replacing the batteries and how to set the current time	D-94
3.2.Initial setting	D-95
IV . Operation.....	D-97
4.1.Switching the unit on/off	D-97
4.2.Selecting a temperature	D-97
4.3.Selecting a fan speed (FAN)	D-98
4.4.Adjusting airflow direction	D-98
4.5.Using the on/off timer	D-99
4.6.Using the weekly timer	D-100
4.7.i-see Sensor	D-101
V . Special Operation	D-102
5.1.Setting the fixed airflow direction	D-102
5.2.Operating the ascending/descending panel	D-103
VI . Centrally Controlled	D-103
VII . Troubleshooting	D-103



WIRELESS
 REMOTE
 CONTROLLER
 [PAR-SL100A-E]

I . Safety Precautions

- Be sure to read these Safety precautions thoroughly and install the remote controller correctly.
- The following two symbols are used to denote dangers that may be caused by incorrect use. They are classified according to the degree of danger.

⚠ WARNING: This symbol denotes what could lead to serious injury or death if you misuse the controller.

⚠ CAUTION: This symbol denotes what could lead to personal injury or damage to your property if you misuse the controller.

- After reading this manual, be sure to forward it, together with the operation manual accompanying the indoor unit, to the user. Together with the operation manual for the indoor unit, this manual should be kept in a place where it can be referred to at anytime by the user. When the user changes, be sure to forward the manual to the final user.

⚠ WARNING

- **Check the installation conditions.**
 - In order to prevent the controller falling down, make sure that it is installed in a place strong enough to withstand its weight.
- **Do not dispose of the controller by yourself.**
 - Consult your dealer in case of disposal.
- **Stop operation when an abnormality occurs.**
 - Continuing to operate under abnormal conditions can result in breakdown, electric shock or fire. When an abnormality occurs (burning smell etc.), stop operations, turn off the power switch and consult your dealer.
- **Never modify or repair the controller by yourself.**
 - Any deficiency caused by your modification or repair may result in an electric shock or fire. Consult your dealer about repairs.
- **Stop operation if the operation lamp on the controller's receiver blinks or if an abnormality occurs.**
 - Leaving the controller in these conditions can lead to fire or breakdown. Report such conditions to your dealer.
- **Never allow the alkaline batteries to short-circuit. Never disassemble, heat or place them in fire.**
 - Doing so can cause the strong alkaline liquid to leak and possibly enter your eyes or cause the batteries to explode or heat up, resulting in personal injuries, burning or mechanical breakdowns. If strong alkaline liquid comes in contact with your skin or clothes, wash it off with clean water. If it gets in to your eyes, wash them with clean water and consult a doctor immediately.

⚠ CAUTION

- **Do not drop the controller.**
 - Doing so may cause the case to crack and may disable control.
- **Do not place any dangerous substances near the controller.**
 - Do not install in any place exposed to leakage of flammable gas. Flammable gases accumulated around the controller may cause fire or an explosion.
- **Do not wash with water.**
 - Doing so may cause an electric shock or breakdown.
- **Do not touch any control button with wet hands.**
 - Doing so may cause an electric shock or breakdown.
- **Do not disassemble the controller.**
 - Contact with internal circuitry may cause fire or breakdown.
- **Do not use in special environments.**
 - Using in places exposed to oil (including machine oil), steam or sulfur gas can reduce the performance or can cause damage to the components.
- **Do not spray insecticide or other flammable sprays.**
 - Do not place flammable sprays near the controller or spray directly at the controller. Doing so may result in fire or explosion.
- **Do not wipe the controller with benzine, thinner or chemical cloths etc.**
 - Doing so may cause discoloration or breakdowns. If the controller becomes extremely dirty, dampen a cloth with water-diluted neutral detergent and wipe the controller with it, then wipe with a dry cloth.
- **Do not press any control button with a sharp object.**
 - Doing so may cause an electric shock or breakdown.
- **Keep the temperature within the specified range.**
 - Use the controller within the specified operating temperature range. Using in temperature outside that range can cause serious breakdowns.
 - For the specified operating temperature range, refer to the specifications given on the operation manual.
- **Do not use for other special purposes.**
 - The controller has been designed for use with the Multi air conditioner and Slim air conditioner only. Do not use for other purposes such as controlling other air conditioners. Doing so may result in breakdown.
- **Incorrect use of batteries can cause liquid leakage, explosion or heating and may result in breakdown or personal injury. Adhere to the following.**
 - (1) Do not recharge the batteries.
 - (2) Insert the batteries in the correct direction.
 - (3) Do not mix a new battery with an old battery or batteries of different types.
 - (4) Remove the batteries immediately when they have run out.

II. Names and functions of controller components

Controller interface

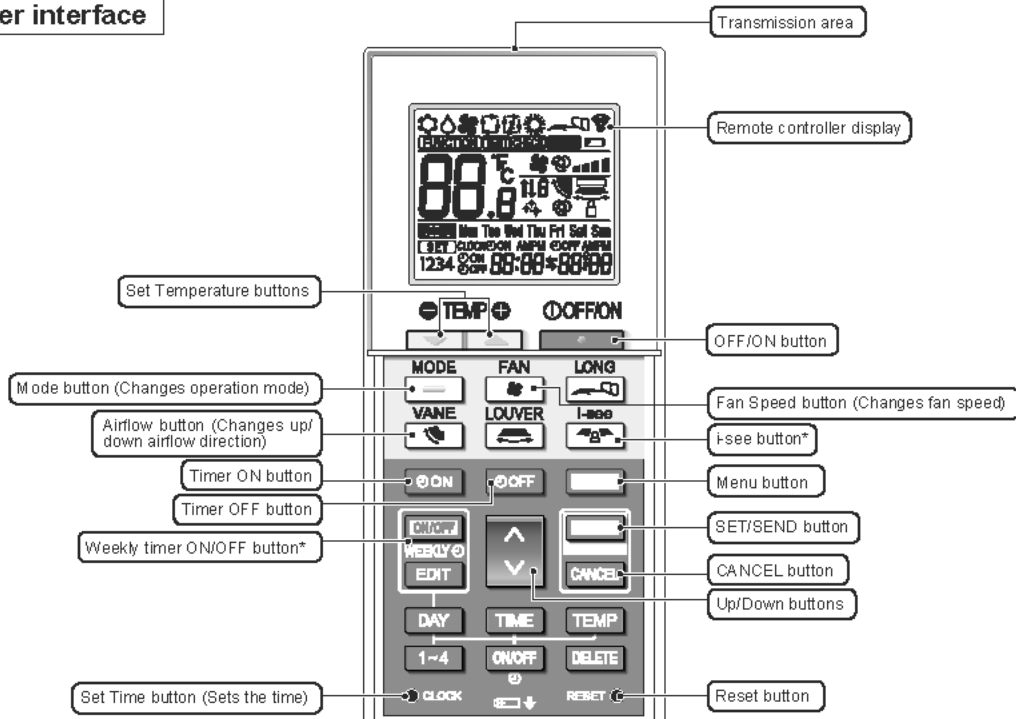

Note:
* This button is enabled or disabled depending on the model of the indoor unit.

Display

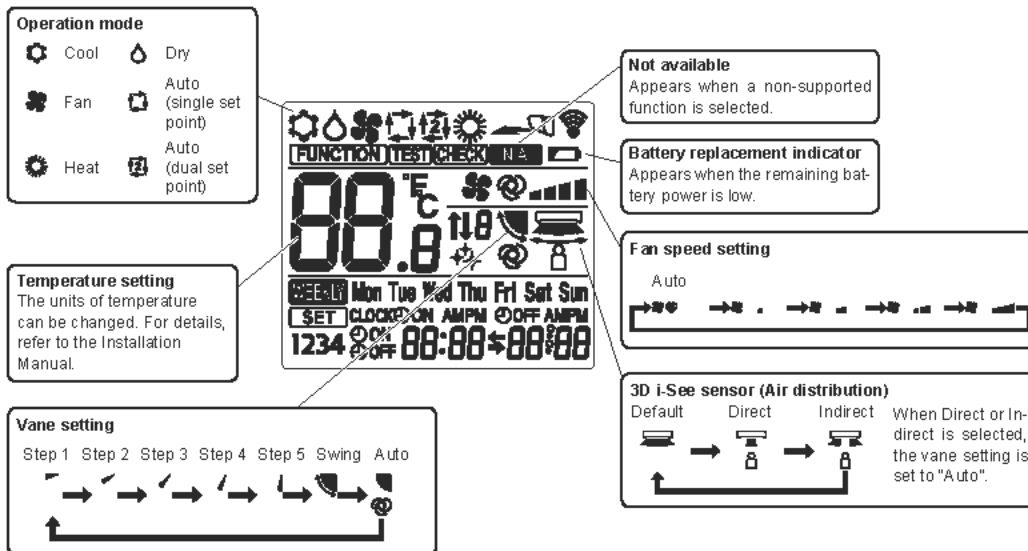

Note:

- When using the wireless remote controller, point it towards the receiver on the indoor unit.
- If the remote controller is operated within approximately 2 minutes after power is supplied to the indoor unit, the indoor unit may beep twice as the unit is performing the initial automatic check.
- The indoor unit beeps to confirm that the signal transmitted from the remote controller has been received. Signals can be received up to approximately 7 meters (Approx. 22 feet) in a direct line from the indoor unit in an area 45° to the left and right of the unit. However, illumination such as fluorescent lights and strong light can affect the ability of the indoor unit to receive signals.
- If the operation lamp near the receiver on the indoor unit is blinking, the unit needs to be inspected. Consult your dealer for service.
- Handle the remote controller carefully! Do not drop the remote controller or subject it to strong shocks. In addition, do not get the remote controller wet or leave it in a location with high humidity.
- To avoid misplacing the remote controller, install the holder included with the remote controller on a wall and be sure to always place the remote controller in the holder after use.
- If the indoor unit beeps 4 times when you are using the wireless remote controller, switch the auto mode setting to the AUTO (single set point) mode or AUTO (dual set point) mode.
For details, refer to the included Notice (A5 sheet) or the Installation Manual.

Names and functions of controller components [PAR-SL100(A-E)]

WIRELESS REMOTE CONTROLLER

III . Before Operation

3.1. Replacing the batteries and how to set the current time

Battery installation/replacement

1. Remove the top cover, insert two LR6 AA batteries, and then install the top cover.

2. Press the Reset button.

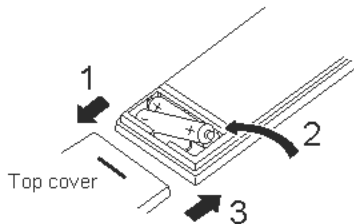

Two LR6 AA batteries
Insert the negative (-) end of each battery first. Install the batteries in the correct directions (+, -)!

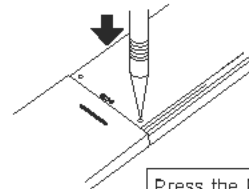

Press the Reset button with an object that has a narrow end.

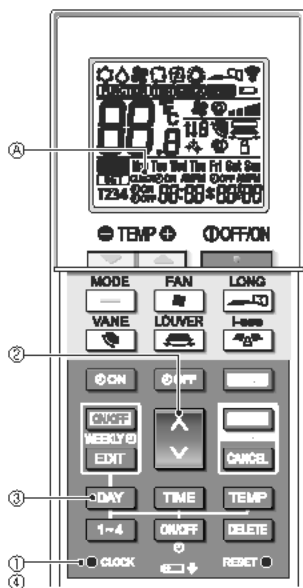

How to set the current time

- The transmission mark appears each time a signal is transmitted.
- The indoor unit beeps to confirm that the signal transmitted from the wireless remote controller has been received by the receiver on the indoor unit. If the indoor unit does not beep, transmit the signal again.

1. Press the button ①. [CLOCK] blinks.
2. Press the button ② to set the current time.
 - Press the button to increase the current time. Press the button to decrease the current time.
 - Hold down the button to increase or decrease the time in 10-minute increments.
3. Press the button ③ to set the day.
 - Each time the button is pressed, the day changes in the following repeating order: Monday → Tuesday → ... Sunday → Monday → ...
4. Press the button ④ to confirm the current time settings.
 - [CLOCK] stops blinking and remains on, and the current day and time are displayed.

3.2. Initial setting

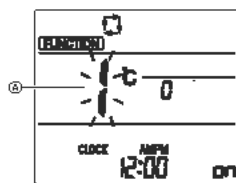
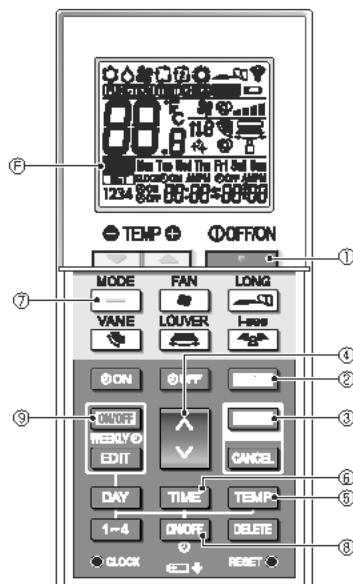

Fig. 3-1

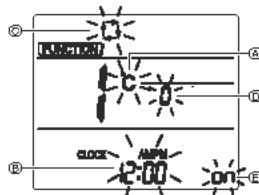

Fig. 3-2

The following settings can be made in the initial setting mode.

Item	Setting	Fig. 3-1, 3-2
Temperature unit	°C/°F	Ⓐ
Time display	12-hour format/24-hour format	Ⓑ
AUTO mode	Single set point/Dual set point	Ⓒ
Pair No.	0-3	Ⓓ
Backlight	On/Off	Ⓔ

1) Switching to the initial setting mode

- Press the **OFF** button ① to stop the air conditioner.
 - If the weekly timer is enabled, press the **WEEKLY** button ⑨ to disable the timer. (**WEEKLY** ⑨ disappears.)
- Press the **FUNCTION** button ②.
 - The Function setting screen will be displayed and the function No. ① will blink. (Fig. 3-1)
 - Press the **UP** button ④ to change the function No.
- Check that function No. "1" is displayed, and then press the **ENTER** button ③.
 - The display setting screen will be displayed. (Fig. 3-2)

2) Changing the temperature unit ① [Factory setting: °C] (Fig. 3-2)

- Press the **TEMP** button ⑤.
- Each time the **TEMP** button ⑤ is pressed, the setting switches between **°C** and **°F**.
 - °C**: The temperature is displayed in degrees Celsius.
 - °F**: The temperature is displayed in degrees Fahrenheit.

3) Changing the time display ⑦ [Factory setting: 12-hour format] (Fig. 3-2)

- Press the **TIME** button ⑥.
- Each time the **TIME** button ⑥ is pressed, the setting switches between **12:00** and **24:00**.
 - 12:00**: The time is displayed in the 12-hour format.
 - 24:00**: The time is displayed in the 24-hour format.

4) Changing the AUTO mode ⑧ [Factory setting: Single set point] (Fig. 3-2)

- Press the **MODE** button ⑦.
- Each time the **MODE** button ⑦ is pressed, the setting switches between **□** and **□**.
 - : The AUTO mode operates as the usual automatic mode.
 - : The AUTO mode operates using dual set points.

* The AUTO (dual set point) mode cannot be used depending on the models of the connected indoor and outdoor units.

5) Changing the pair No. ⑨ [Factory setting: 0] (Fig. 3-2)

- Press the **PAIR** button ④.
- Each time the **PAIR** button ④ is pressed, the pair No. 0-3 changes.

6) Changing the backlight setting ⑺ [Factory setting: ON] (Fig. 3-2)

- Press the **ON/OFF** button ⑩.
- Each time the **ON/OFF** button ⑩ is pressed, the setting switches between **on** and **off**.
 - on**: The backlight comes on when a button is pressed.
 - off**: The backlight does not come on when a button is pressed.

7) Completing the settings

- Press the **ENTER** button ③.
- The function No. ① blinks. (Fig. 3-1)
- Press the **FUNCTION** button ②.
- The remote controller exits the initial setting mode. (The air conditioner operation is stopped.)
 - The transmission mark **▶** appears each time a signal is transmitted.
 - The indoor unit beeps to confirm that the signal transmitted from the wireless remote controller has been received by the receiver on the indoor unit. If the indoor unit does not beep, transmit the signal again.

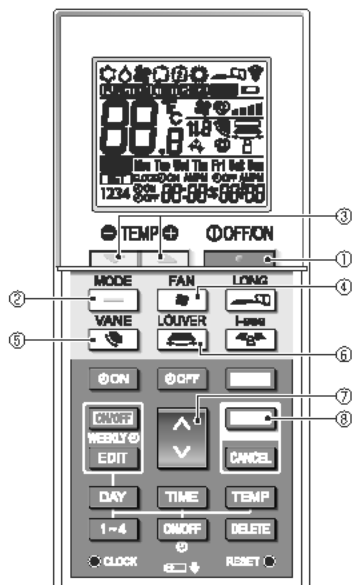

8) Operation mode setting

1. Press the button ① to stop the air conditioner.
2. Press the button ② in 5 seconds. Model setting screen will be displayed.
3. Press the button ③. Operation mode ④ blinks. (Fig. 3-3)
4. Press the button ⑦ to change setting No.

Operation mode display ④	Setting No. ⑤	Operation mode display ④	Setting No. ⑤
	01		05
	02		06
	03		07
	04		

5. Press the button ⑧ in 5 seconds to complete the setting.

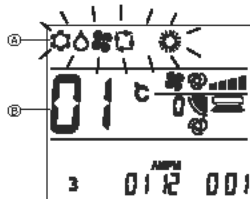
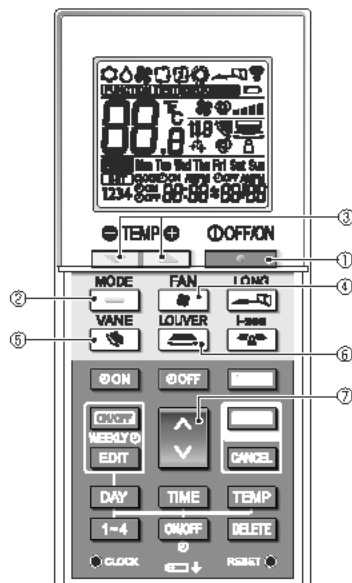

Fig. 3-3

IV. Operation

4.1. Switching the unit on/off



1. Press the button ①.
 - The remote controller display turns on.
2. Press the button ②.
 - Each time the button is pressed, the setting changes.



- * If the automatic operation is selected, cooling operation starts if the room temperature is higher than the set temperature and heating operation starts if the room temperature is lower than the set temperature. If the AUTO (dual set point) mode is enabled, is displayed. When setting the AUTO (dual set point) mode, you can set 2 temperatures (1 temperature for cooling and 1 temperature for heating). According to the room temperature, the indoor unit operates automatically in the cooling or heating mode to keep the room temperature within the set range.
- * The AUTO (dual set point) mode cannot be used depending on the model of the connected outdoor unit.

<Auto operation (dual set point) mode>

When the operation mode is set to the Auto (dual set point) mode, two preset temperatures (one each for cooling and heating) can be set. Depending on the room temperature, indoor unit will automatically operate in either the Cool or Heat mode and keep the room temperature within the preset range.

The graph below shows the operation pattern of indoor unit operated in the Auto (dual set point) mode.

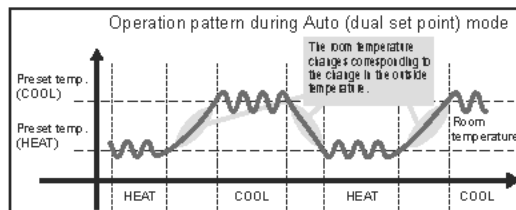

4.2. Selecting a temperature

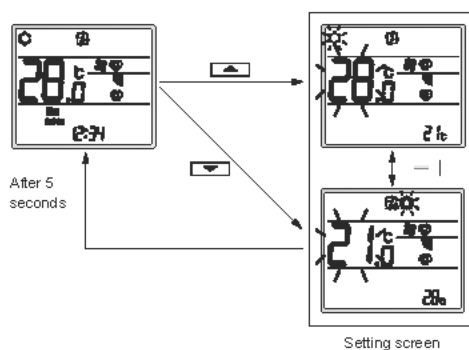

- To decrease the temperature, press the button ③.
- To increase the temperature, press the button ③.
- Each time the button is pressed, the set temperature changes 0.5°C.
 - The setting ranges for the temperature are as follows.

Cool/Dry	Heat	Auto	Fan
19–30°C	17–28°C	19–28°C	Not settable

When using the AUTO (dual set point) mode

- The set temperature for the current operation mode, cooling or heating, is displayed.
- When the or button ③ is pressed, the set temperature blinks and the setting screen is displayed.
 - To change the upper limit (cooling) for the set temperature range, press the button ③.
 - To change the lower limit (heating) for the set temperature range, press the button ③.
- In the setting screen, press the button ② to switch the blinking display between the upper limit (cooling) and lower limit (heating).
- Press the or button ③ in the setting screen to change the blinking set temperature.
- If no operations are performed for 5 seconds, the display returns to the previous screen.
- * The difference between the upper limit (cooling) and lower limit (heating) cannot be set to less than 2°C.
- * The AUTO (dual set point) mode cannot be used depending on the models of the connected indoor and outdoor units.

4.3. Selecting a fan speed (FAN)

Press the  button ④.

- Each time the button is pressed, the setting changes.



- The available fan speeds depend on the model of the indoor unit.

Note:

In the following cases, the actual fan speed generated by the unit may be different from the speed shown on the remote controller display.

- The unit is performing the warming-up operation or the defrosting operation.
- Immediately after starting the heating operation (while the system is waiting for the mode change to take effect).
- In the heating mode, the room temperature is higher than the temperature setting.
- The unit is in the dry mode.

4.4. Adjusting airflow direction

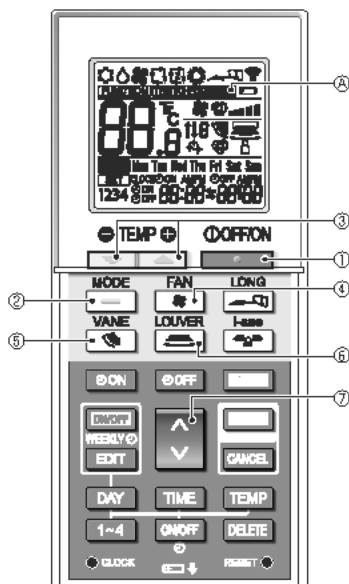

<Changing the vertical airflow direction (vane)>

Press the  button ⑤.

- Each time the button is pressed, the setting changes.

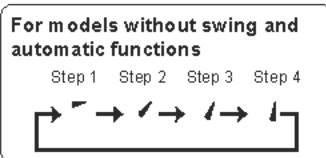
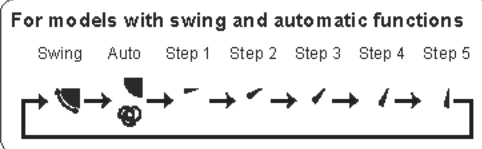



- * For models that are not equipped with a vertical airflow setting function,  ⑤ blinks twice when the vertical airflow direction is set.

<Changing the horizontal airflow direction (louver)>

Press the  button ⑥.

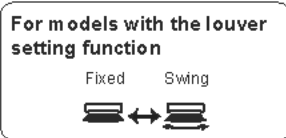
- Each time the button is pressed, the setting switches between the swing operation and the fixed operation.



- * For models that are not equipped with a horizontal airflow setting function,  ⑥ blinks twice when the horizontal airflow direction is set.

Note:

In the following cases, the vertical airflow direction of the unit may be different from the direction shown on the remote controller display.

- The unit is performing the warming-up operation or the defrosting operation.
- Immediately after starting the heating operation (while the system is waiting for the mode change to take effect).
- In the heating mode, the room temperature is higher than the temperature setting.

4.5. Using the on/off timer

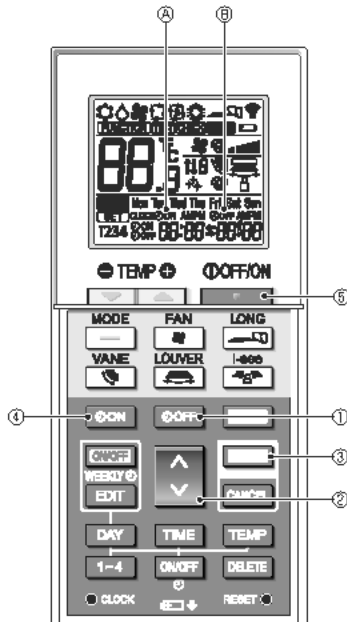
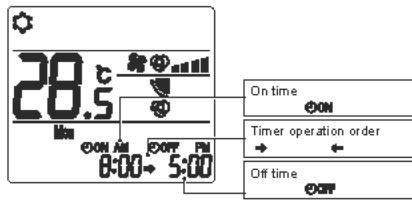

• When setting the timer operation, point the transmission area of the wireless remote controller towards the receiver on the indoor unit and confirm that the indoor unit beeps when it receives signals from the remote controller.

- There are 3 types of timer operation.
 - On timer operation: Only the timer to start the operation is set.
 - Off timer operation: Only the timer to stop the operation is set.
 - On/off timer operation: The timers to start and stop the operation are both set.
- Only 1 on-timer setting and 1 off-timer setting can be set for the timer operation within a 24-hour period.
- The time setting for the timer operation can be set in 10-minute increments.

[Set the time to start the unit as follows]

1. Press the **ON** button ①.
 - The current time disappears, the on time appears, and **ON** ① blinks.
2. Press the **▲** button ② to set the on time.
3. Press the **■** button ③.
 - **ON** ① stops blinking and remains on to indicate that the setting is complete.
 - * Even if no operations are performed for 10 seconds, **ON** ① stops blinking and remains on to indicate that the setting is complete.
 - If the on timer is set while the air conditioner is operating, the air conditioner stops.

[Set the time to stop the unit as follows]

1. Press the **OFF** button ①.
 - The current time disappears, the off time appears, and **OFF** ① blinks.
2. Press the **▼** button ② to set the off time.
3. Press the **■** button ③.
 - **OFF** ① stops blinking and remains on to indicate that the setting is complete.
 - * Even if no operations are performed for 10 seconds, **OFF** ① stops blinking and remains on to indicate that the setting is complete.

[Changing the set times]

Set both the off timer and on timer.

- In the **★** display, **→** or **←** appears.
 - **→**: Stops → Operates (on time) → Stops (off time)
 - **←**: Operates → Stops (off time) → Operates (on time)

Example 1) The current time is 7:00 A.M.
The air conditioner starts operating at 8:00 A.M.
and stops at 6:30 P.M.

Example 2) The current time is 10:00 A.M.
The air conditioner stops operating at 6:30 P.M.
and starts at 8:00 A.M. on the following day.

[Canceling the timer operation]

- Canceling the on timer operation
 - Press the **ON** button ①.
 - The on time disappears and the on timer is canceled.
- Canceling the off timer operation
 - Press the **OFF** button ①.
 - The off time disappears and the off timer is canceled.
- Canceling the on/off timer operation
 - Press the **ON** button ① or the **OFF** button ①.
 - The on time and off time disappear and the timer is canceled.
- Canceling the timer operation and stopping the air conditioner
 - Press the **■** button ③.
 - The air conditioner stops and the set timer operation is canceled at the same time.

WIRELESS REMOTE CONTROLLER
IV. Operation (PAR-SL100A-E)

4.6. Using the weekly timer

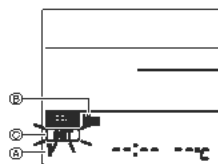
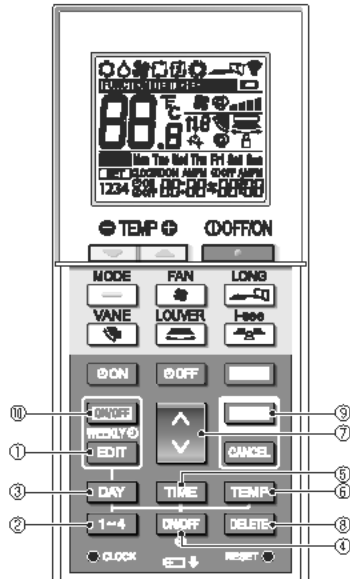

Fig. 4-1



Fig. 4-2



Fig. 4-3



Fig. 4-4



Fig. 4-5

- This function cannot be operated depending on the model of the indoor unit.
- The weekly timer can be set to 4 operation patterns for each day of the week.
- The settings include the on and off times and the set temperature.
- The operation time can be set in 10-minute increments.

<Switching to the editing mode>

Press the **EDIT** button ①.

- **EDIT** ① blinks. (Fig. 4-1)

<Selecting the setting pattern>

Press the **1-4** button ②.

- Each time the **1-4** button ② is pressed, the pattern number ② changes in the following order: 1 → 2 → 3 → 4. (Fig. 4-1)

<Selecting the day of the week>

Press the **DAY** button ③.

- Each time the **DAY** button ③ is pressed, the day of the week ③ changes in the following order: Mon → Tue → Wed → Thu → Fri → Sat → Sun → All days. (Fig. 4-1)

<Selecting the operation settings>

1. Press the **ON/OFF** button ④.

- **ON** ④ (**OFF**) appears. (Fig. 4-2)
- Each time the **ON/OFF** button ④ is pressed, the setting switches between **ON** ④ and **OFF**.

2. Press the **TIME** button ⑤.

- The operation time blinks. (Fig. 4-3)
- Press the **↑** button ⑦ to set the operation time.

3. Press the **TEMP** button ⑥.

- The set temperature blinks. (Fig. 4-4)
- Press the **↑** button ⑦ to set the temperature.
- When the AUTO (dual set point) mode is enabled, press the **TEMP** button ⑥ to switch between the upper limit ⑧ and the lower limit ⑨. (Fig. 4-5)

* When setting the off operation, the temperature cannot be set.

<Deleting the settings>

Press the **DELETE** button ⑧.

- The displayed day of the week and the pattern number settings are deleted.

<Transmitting the settings>

Point the transmission area of the wireless remote controller towards the receiver on the indoor unit and operate the controller. Confirm that the indoor unit beeps 7 times.

Press the **ON/OFF** button ④.

<Enabling the weekly timer>

Point the transmission area of the wireless remote controller towards the receiver on the indoor unit and operate the controller.

Press the **ON/OFF** button ④.

The weekly timer operates when **ON** is on.

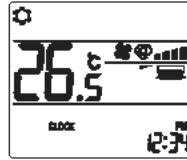

- The weekly timer does not function when the on/off timer is enabled.
- The weekly timer operates when all of the on/off timer settings have been executed.

4.7. i-see Sensor



- This function cannot be operated depending on the model of the indoor unit.

① Each time  is pressed during operation, the setting changes in the following order: OFF → Direct → Indirect.

Display			
Setting	OFF	Direct	Indirect

When the setting is changed from OFF to Direct or Indirect, the vane setting changes to "Auto". This setting is applied collectively to all of the vanes.

② The vanes automatically move relative to the areas where persons are detected. When a person is detected, the vanes operate as indicated in the following table.

	Vane setting	
	Direct	Indirect
Cooling	horizontal → swing	keep horizontal
Heating	keep downward	downward → horizontal

V. Special Operation

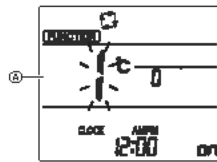
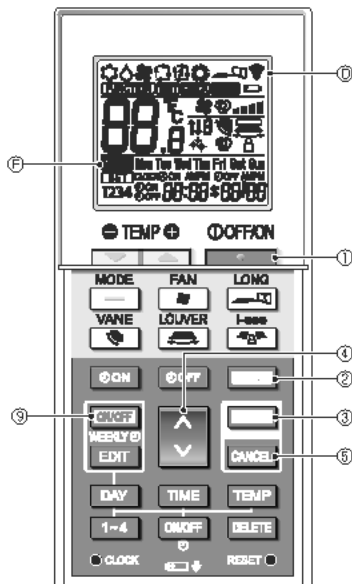

Some functions cannot be operated depending on the air conditioner. Confirm whether the air conditioner supports each function, and then operate the air conditioner.

<Switching to the special operation mode>

1. Press the **OFF** button ① to stop the air conditioner.
 - If the weekly timer is enabled, press the **ON** button ② to disable the timer. (**ON** ② disappears.)
2. Press the **ON** button ②.
 - The Function setting screen will be displayed and the function No. ④ will blink.

<Transmitting the settings>

- When you perform each operation, **ON** ② on the remote controller display blinks to indicate that the **VANE** button ③ must be pressed to transmit the settings. Point the transmission area of the wireless remote controller towards the receiver on the indoor unit and press the **VANE** button ③ to transmit the settings. Confirm that the indoor unit beeps at this time.

<Exiting the special operation mode>

1. While the operation screen for each function is displayed, press the **ON** button ② or the **CANCEL** button ⑥.
 - The Function setting screen will be displayed and the function No. ④ will blink.
2. Press the **ON** button ②.
 - The display returns to the normal screen.

5.1. Setting the fixed airflow direction

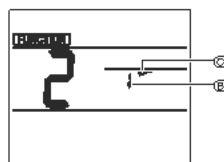

Fig. 5-1

1. In the Function setting screen, press the **VANE** button ③ and select function No. "2".
2. Press the **VANE** button ③.
 - The vane number ② blinks. (Fig. 5-1)
3. Press the **VANE** button ③ to select the vane number.
 - For information about the vane numbers, refer to the indoor unit operation manual.
4. Press the **VANE** button ③.
 - The airflow direction setting ① blinks. (Fig. 5-1)
5. Press the **VANE** button ③ to select the airflow direction at which you want to fix the vane.

Step 1	Step 2	Step 3	Step 4	Step 5
-	/	/	/	/
No setting	Draft reduction			
/	(No display)			

6. Press the **VANE** button ③ to transmit the settings.

Note:

Draft reduction

The airflow direction for this setting is more horizontal than the airflow direction for the "Step 1" setting in order to reduce a drafty feeling. The draft reduction can be set for only 1 vane. The setting is enabled only for the last vane that was set.

5.2. Operating the ascending/descending panel

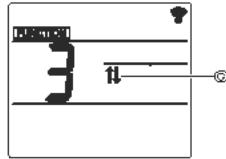

Fig. 5-2

1. In the Function setting screen, press the button ④ and select function No. "3".
2. Press the button ③.
 - The ascending/descending mark ⑤ blinks. (Fig. 5-2)
3. Press the button ④ or the button ⑤.
 - : Descending operation
 - : Ascending operation
 - : Stop operation

VI. Centrally Controlled

<When remote operation by other remote controllers is prohibited>

When remote operation is prohibited by a central remote controller, the operations for stopping and starting operation and the settings for the operation mode, temperature setting, vane setting, and fan speed cannot be performed from this remote controller according to the prohibited settings.

<When a wireless remote controller is operated during central control>

The receiver of the wireless remote controller operates as follows.

Reception confirmation sound: 2 beeps

Operation lamp during operation: Turns off 3 times in 0.5-second intervals

Operation lamp when operation is stopped: Turns on 3 times in 0.5-second intervals

VI. Troubleshooting

<When the operation lamp of the wireless remote controller receiver is blinking>

The blinking lamp indicates an air conditioner malfunction has occurred.

If this occurs, turn off the power switch immediately and consult your dealer.

Do not attempt to repair this equipment by yourself.

<When the indoor unit beeps 4 times and the operations are ineffective>

The auto mode setting (single set point or dual set point) is different for the remote controller and the system to which the indoor unit is connected. Change the current setting according to the procedure in 4) in 3.2.