



Air Cooling Energy Storage System

AELIO-P50B200 / AELIO-P60B200

Maintenance Manual

Version 0.0

www.solaxpower.com



STATEMENT

Copyright

Copyright © SolaX Power Network Technology (Zhejiang) Co., Ltd. All rights reserved.

No part of this manual may be reproduced, transmitted, transcribed, stored in a retrieval system, or translated into any language or computer language, in any form or by any means without the prior written permission of SolaX Power Network Technology (Zhejiang) Co., Ltd.

Trademarks



SOLA_X and other symbol or design (brand name, logo) that distinguishes the products or services offered by SolaX has been trademark protected. Any unauthorized use of the above stated trademark may infringe the trademark right.

Notice

Please note that certain products, features, and services mentioned in this document may not be within the scope of your purchase or usage. Unless otherwise specified in the contract, the contents, information, and recommendations presented in this document are provided "as is" by SolaX. We do not provide any warranties, guarantees, or representations, whether express or implied.

The content of the documents is reviewed and updated as needed. However, occasional discrepancies may occur. SolaX retains the right to make improvements or changes in the product(s) and the program(s) described in this manual at any time without prior notice.

The images included in this document are solely for illustrative purposes and may differ based on the specific product models.

For more detailed information, kindly visit the website of SolaX Power Network Technology (Zhejiang) Co., Ltd. at www.solaxpower.com.

SolaX retains all rights for the final explanation.

About This Manual

Scope of Validity

This document describes routine maintenance, troubleshooting, and parts replacement of AELIO-P50B200 and AELIO-P60B200 product. Please read it carefully before maintaining.



Target Group

This document is intended for:

- Technical support engineers
- Maintenance engineers

Conventions

The symbols that may be found in this manual are defined as follows.

Symbol	Description
 DANGER	Indicates a hazardous situation which, if not avoided, will result in death or serious injury.
 WARNING	Indicates a hazardous situation which, if not avoided, could result in death or serious injury.
 CAUTION!	Indicates a hazardous situation which, if not avoided, could result in minor or moderate injury.
NOTICE!	Provides tips for the optimal operation of the product.

Change History

Version 00 (2025-04-08)

Initial release

Table of Contents

1	Safety	1
1.1	General Safety.....	1
1.2	Personal Safety.....	2
1.3	Environment Requirement.....	3
1.4	Cabinet, Battery and Electric Safety.....	4
1.4.1	Cabinet Safety.....	4
1.4.2	Battery Safety.....	7
1.4.3	Electrical Safety.....	11
1.5	Safety Instructions of PV, Inverter and Grid.....	14
1.5.1	Safety Instructions of PV.....	14
1.5.2	Safety Instructions of Inverter.....	15
1.5.3	Safety Instructions of Utility Grid.....	16
2	Routine Maintenance	17
2.1	Preparations Before Maintenance.....	17
2.2	Routine Maintenance.....	17
2.3	Power Off.....	22
2.4	Power On.....	27
3	Alarm Reference	33
3.1	Cabinet Screen.....	33
3.1.1	Logging in.....	33
3.1.2	Viewing Alarms.....	34
3.2	EMS1000 Webpage.....	36
3.2.1	Logging in.....	36
3.2.2	Viewing Alarms.....	37
3.3	SolaXCloud App.....	38
3.3.1	Downloading and Installing App.....	38
4	Disassembly and Clean of Air Conditioner Filter	40
5	Replacement of Antenna	42
6	Replacement of Battery Pack	44
7	Replacement of Battery Pack Fan	51
8	Replacement of BMU	55
9	Replacement of High-voltage Box	60

10 Replacement of SBMU 68

11 Replacement of High-voltage Box Fuse 77

12 Replacement of High-voltage Box Contactor..... 85

13 Replacement of EMS1000..... 95

14 Replacement of Switch.....100

15 Replacement of I/O Module 105

16 Replacement of UPS 109

17 Replacement of Air Conditioner 113

18 Replacement of Temperature and Humidity Sensor 117

19 Replacement of Door Sensor 120

20 Replacement of Smoke Detector and Temperature Sensor 123

21 Replacement of Distribution Box 125

22 Replacement of SPD Module 140

23 Replacement of Audible and Visible Alarm 144

24 Replacement of CO Detector 147

25 Replacement of Water Sensor 150

26 Replacement of EPS Switch..... 152

27 Replacement of UPS Switch 155

28 Replacement of Inverter Fans 158

29 Replacement of Inverter..... 164

30 Checking after Replacement..... 165

1 Safety

1.1 General Safety

Before transporting, storing, installing, operating, using and/or maintaining the equipment, please carefully read the document, and strictly follow the instructions and safety precautions given herein, as well as symbols affixed on the equipment.

The operator should not only abide by all safety precautions provided in the document, including but not limited to the "Danger" sign, "Warning" sign, "Caution" sign, and "Notice" sign, but also comply with relevant international, national and local laws and regulations, and industry rules. SolaX will not assume any responsibilities for the loss caused by improper operation, or violation of safety standards for design, production and equipment suitability.

SolaX will not be liable for maintenance for possible device failure, device malfunction, or parts damage, nor will the company assume any liability to pay compensation for the possible physical and property damage resulting from the installation environment that does not meet the design requirements.

The operator should comply with the local laws, regulations, standards and guidelines in the process of transportation, storage, installation, operation, and maintenance.

The device is well designed and tested to meet all applicable states and international safety standards. However, like all electrical and electronic equipment, safety precautions must be observed and followed during the installation of the device to reduce the risk of personal injury and to ensure a safe installation.

Before installing the device, carefully read, fully understand and strictly follow the detailed instruction of the *User Manual* and other related regulations. And the safety instructions in this document are only supplements to local laws and regulations.

SolaX will not assume any responsibilities if any of the following circumstances occurs, including but not limited to:

- Device damage due to force majeure, such as earthquake, flooding, thunderstorm, lighting, fire hazard, volcanic eruption, war, typhoon, tornado, etc.
- Device damage due to human cause.
- Device damage caused by strong vibrations from external factors before, during and after installation.
- Device used or operated against local policy or regulations.
- Failure to follow the operation instructions and safety precautions on the product and in this document.
- Installation and use under improper environment or electrical condition.
- Unauthorized modifications to the product or software.

- Device damage caused during transportation by the customer or the third party.
- Storage conditions that do not meet the requirements specified in this document
- Use of incompatible inverters or devices.
- Installation and commissioning operated by unauthorized personnel who are not licensed and /or satisfy state and local jurisdiction regulations.

1.2 Personal Safety

DANGER!

- Do not power on while installing the device. If the device is powered on in the process of installation and disassembly of cables, an electric arc, electric spark or fire will occur at the moment that the cable core contacts conductors. It may cause a fire or result in physical and property damage.
- Do not improperly operate while powering on. Any improper operation may cause a fire, electric shock, or explosion, and it will result in physical and property damage.
- Must remove rings, bracelets, watches, and any other metal jewelry from fingers, hands, or wrists before operation, to avoid electrical shock or burn.
- Must use special insulation tools, of which the insulation grade and dielectric strength level must be consistent with local laws, regulations, standards, and guidelines, in the operation process, to avoid electrical shock, burn, or short circuit fault.

WARNING!

- Must wear special personal protective equipment (PPE), such as a coverall, safety boots, safety glasses, safety helmet, safety gloves, etc.

CAUTION!

- Do not stop the safety switch on the device, and neglect the "Danger" sign, "Warning" sign, "Caution" sign, and "Notice" sign on the device, as well as safety precautions in the document.
- Must stop working at once, report to the relevant person in charge, and activate protection schemes in case of possible danger that may cause human injury and damage to device in the installation and operation process.
- Do not power on during the installation process, or before obtaining confirmation from professionals after finishing installation.
- Do not directly contact power supply device, or contact it with other conductors or wet objects.
- Do not touch the running fan with parts, screws, or installation tools, or keep hands clear when the fan is running, to avoid personal injury or property damage.
- Please evacuate and press the fire bell immediately, or call fire department at once in the case of a fire.

1.3 Environment Requirement

DANGER!

The device installation site shall meet the following requirements:

- Keep away from combustibles and explosive materials.
- Keep away from heat or fire sources, such as fireworks, candles, heaters, or any other heat-producing appliances. It may cause damage to device or a fire.
- Keep away from flammable and explosive gases, or smoky environments.

WARNING!

- The device installation site should keep away from liquid areas, such as positions under a water pipe or air outlet where the condensed water is easy to form, or positions under an air-conditioning vent, ventilation opening or device room outlet where there is access to water. The water can seep into the internal components of the device, causing device damage and short circuits.
- Do not cover vents and cooling systems while running. Otherwise, it may cause a fire or device damage due to the high temperature.
- Do not try to open the cabinet doors on a rainy or high humid day (humidity equal to or greater than 80%). If the cabinet doors happen to be opened on a rainy day, a covering must be arranged to protect the modules in it from water. If the cabinet doors have been opened for over 30 minutes on a highly humid day when the cabinet is off-grid or under grid connection, the operator needs to manually dehumidify. Otherwise, it may not work properly or not connect to the network properly.

CAUTION!

- The storage area should be clean, dry, and well ventilated to prevent dust from entering, and condensed water from generating.
- Strictly observe technical specifications while installing and running the device. Or, it may affect the performance and safety of the device.
- Do not install, run or operate outdoor device or cables (including but not limited to carrying device, operating device, connecting cables, plugging or unplugging cables that connect to outdoor signal ports, working at heights, outdoor installation, etc.) in bad weather, such as thunderstorms, rain, snow, etc.
- Keep away from the following environments while installing the device: environments with dust, smoke, volatile gases, corrosive gases, infrared radiation, organic solvents, or a site with high salt.
- Keep away from environments with metal-conductive or magnetic-conductive dust.
- Keep away from areas suitable for fungus, mould, or other microorganism growth.
- Keep away from areas with strong shaking, serious noise pollution, or powerful electromagnetic interference.
- The installation site must conform to local laws and regulations, and relevant standards.

 CAUTION!

- The ground at the installation site must be firm and strong instead of having an adverse geological condition, such as soil with high water content, weak soils, or loose soils. And keep away from low-lying areas since they are prone to water or snow accumulation.
- Keep away from areas prone to water accumulation.
- If the device is installed on a grassy plantation, do weed regularly, and harden the ground under the device, such as cementing, gravelling, etc.
- When the operator plans to install, operate or maintain the device, water, snow, or other objects must be cleared on the top of the device before opening doors to keep them from entering into the device.
- Please check the ground is firm and strong enough to meet the load-bearing requirements of the device while it is being installed.
- Must seal the entry holes.
- Must clean the packing materials, such as cartons, foams, plastic bags, ties, etc., on the site after finishing installation.

1.4 Cabinet, Battery and Electric Safety

To prevent personal injury or property damage from improper operation, please carefully read the following installation precautions before installation.

1.4.1 Cabinet Safety

 DANGER!

- A safety helmet, belt, or rope must be worn when performing work at height. If the safety rope is adopted, one end must be securely tied to a strong structural part instead of a movable and unsound object or a metal with sharp edges, to prevent fall incidents due to the slip of the rope hook.

 WARNING!

- To ensure that a complete set of tools is prepared, are firm and secure. They must pass the verification of professional authorities. DO NOT use any tools that are broken, failed to verify, or are expired.
- To prevent personal injury or device damage from slopping or collapsing of the cabinet because it is unstable, please check if the cabinet has been secured before placing any devices into it.
- To protect relevant people from injury, take care of the unstable or heavy devices in the cabinet when taking them out.

 **WARNING!**

- Do not drill holes in the device. Otherwise, the sealing performance, electromagnetic shielding performance, or internal components or cables of the device will be destroyed, and it can even cause a short circuit on a circuit board if the metal dust generated by drilling enters into the device.

 **CAUTION!**

Safety precautions for lifting and handling heavy devices:

- To prevent injury from oversize loads, assess the device you're about to lift before you start lifting.
- If more than 2 people lift a device, reasonably arrange to have a balanced weight distribution
- Wear personal protective equipment, such as, safety gloves, safety boots, etc., to prevent needless injuries when lifting devices with bare hands.
- Know the right body posture to prevent personal injuries when lifting devices, for instance, bend at your knees, not at your waist or back, and do not twist your back.
- Hold the handles on the device or put your hands underneath the device to move or lift, and do not hold the handles on the parts installed in it.
- To prevent injuries, do not quickly lift the heavy device above the waist.
- To prevent scratches and dents, or damage to components and cables, avoid impact and falling when moving.
- Be aware of workbenches, slopes, steps, and other places where it is easy to slip when moving devices. Ensure that the passageways are smooth, clean, and away from obstacles.
- To prevent tipover, the forklift's forks must be placed under the load. Center the weight of the load between the forks, and adjust the forks to distribute the weight evenly. Firmly attach the loads to the forks before lifting, and arrange for people to watch for when lifting.
- Sea and road (in good condition) transports are an idea for the device instead of rail and air transports. Transport staff should do their best to avoid bumpiness and inclination as much as possible.

 **CAUTION!**

Safety precautions for working at heights:

- Arrange people to protect workers who work at 2 meters in height or higher.
- Workers who work at 2 meters in height or higher are required to be trained and obtain relevant qualifications.
- In the case of one of the following circumstances, workers should immediately stop operation until the device is inspected and confirmed safe by the relevant safety director and technicians.
 1. Wet steel pipe.
 2. Other situations may be dangerous.

 CAUTION!

- Should mark off a dangerous area, put up Danger signs, and keep unauthorized people from entering the area.
- Should install guardrails and put up "Watch Your Step" and Danger signs at the edges of workplace and holes.
- Do not stack scaffoldings, gangplanks, or other sundries, and keep the ground service staff from staying or passing under the area where the work is being carried out.
- Take caution with the apparatus and tools brought to ensure that they do not fall.

 CAUTION!

Safety precautions for working at heights:

- Workers who work at heights should take advantage of crane slings, baskets, elevating transfer vehicles, cranes, or other methods to transfer objects instead of throwing them from the air to the ground or from the ground to the air.
- Should avoid working on the up and down work platform at the same time. Or, a special protective shed should be built or some protective measures should be taken between two work platforms to protect workers. In addition, do not stack tools and materials on the upper work platform.
- The scaffoldings should be removed from top to bottom instead of being removed at the same time after finishing installation. Take caution when dismantling parts of scaffolding.
- Workers who work at heights must abide by the Safety Regulation for Working at Heights. SolaX will not be liable for personal injury or device damage due to violations of the Regulation.
- Do not play and have a break in the area while working at heights.

 CAUTION!

Crane safety:

- Crane operators are required to be adequately trained, and certified and licensed to operate said device before starting work.
- Must install guardrails and put up Warning signs at the crane working area.
- The groundwork for the hoisting operation must meet the load bearing requirements of the crane.
- Make sure that the hoisting tools have been secured to an object or wall that meets the load bearing requirements before hoisting.
- Keep the ground service staff from staying or passing under the crane boom or suspended load where the work is being carried out.
- Do not drag steel cable rope, cable rope slings, etc., and hit hoisting device with hard objects, when hoisting work is being carried out.
- Make sure that the angle between two cable ropes do not exceed 90° when hoisting.

 CAUTION!

Ladder safety:

- A wood or insulated ladder should be used when working with electricity.
- A platform ladder with handrails is preferred instead of a straight ladder.
- Check that the ladder is in good condition, make sure that the load bearing meets requirements, and strictly prohibit overload.
- Place the ladder on a solid and firm surface, and designate a person to hold it.
- Balance your body to prevent injuries when climbing.
- Make sure that the rope is fastened and secured when using the herringbone ladder to prevent incidents.

 CAUTION!

Drilling safety:

- Wear personal protective equipment when drilling, such as safety glasses, safety gloves, etc.
- Avoid drilling around pipes, and light switches and sockets, as the electrical cables can go horizontally and vertically around these fixtures.
- Cover the device to protect it from dusts and debris entering when drilling, and clean it at once after finishing drilling.

NOTICE!

- The devices must be transported in its original packaging. SolaX will not be held responsible for any damage to the devices caused by improper transportation or by transportation after it has been installed.

1.4.2 Battery Safety

 DANGER!

- Do not connect the positive and negative poles of a battery together. Or, the battery may be short-circuited. A short circuit may cause enormous amounts of current and release large quantities of energy for a short time, which may cause the battery to leak, smoke, release flammable gases, or be in thermal runaway, catch fire, or explode. Therefore, power off the battery before maintenance.
- Overheating the battery can lead to significant risks, including leakage, smoke, release of flammable gases, thermal runaway, fire, or explosion. In case of one of the following circumstances, do not install battery:
 - a. Direct sunlight
 - b. Fire source
 - c. Heater
 - d. Others conditions that can cause overheating
- Never damage the device by crushing, deforming, dropping, impacting, cutting or penetrating with a sharp object, otherwise, it may cause fire or leakage of electrolytes;

 DANGER!

- Never dismantle, change or damage battery, including penetrating with a sharp object, deforming, soaking in water or other liquids, to keep it away from leakage, smoke, release of flammable gases, thermal runaway, fire or explosion.
- Do not touch battery terminals with any other metal objects, which may cause heat or leak.
- Do not mix different types or makes of the battery pack. It may cause leakage or rupture, resulting in personal injury or property damage.
- The battery electrolyte is toxic and volatile. Never get contact with the leaked liquids or inhale gases in the case of the battery leakage or odor. In such a case, keep away from the battery and contact professionals immediately. Those professionals must wear PPE, such as safety glasses, safety gloves, gas masks, protective clothing, etc., power off the device, remove the battery, and contact technical engineers.
- Normally, the battery will not release any gases since it is an enclosed system. However, in the following situations: burnt, needle-pricked, squeezed, struck by lightning, overcharged, or subject to other adverse conditions that may cause battery thermal runaway, the battery may be damaged or an abnormal chemical reaction may occur inside the battery, resulting in electrolyte leakage or production of gases. To prevent fire or device corrosion, ensure that flammable gas is properly exhausted.
- Take steps to protect human beings from the gases released when burning batteries.

 WARNING!

- Install batteries in a dry area. Do not install them under areas prone to water leakage, such as air conditioner vents, ventilation vents, feeder windows of the device room, or water pipes. Ensure that no liquid enters the device to prevent faults or short circuits.
- Equip with fire-fighting device, such as dry sand, carbon dioxide fire extinguisher, etc., when installing and commissioning according to construction standards and requirements. Make sure that the above-mentioned fire-fighting device conforms to local laws, regulations and standards.
- Before unpacking, and in the process of storage and transportation, ensure that the packing cabinets are intact and the batteries are correctly placed according to the labels on the packing cabinets. Do not place a battery upside down or vertically, lay it on one side, or tilt it. Stack the batteries according to the stacking requirements on the packing cabinets. Make sure that the batteries do not fall or get damaged. Otherwise, they will need to be scrapped.
- After packing, the batteries must be correctly placed in accordance with the requirements. Do not place a battery upside down or vertically, lay it on one side, or tilt or stack it. Make sure that the batteries do not impact, fall get damaged. Otherwise, they will need to be scrapped.
- Tighten the screws on copper bars or cables to the torque specified in this document. Periodically confirm whether the screws are tightened, check for rust, corrosion, or other foreign objects, and clean them up if any. Loose screw connections will result in excessive voltage drops and batteries may catch fire when the current is high.
- After batteries are discharged, charge them in time to avoid damage due to overdischarge.

 CAUTION!

- Please read the document carefully before installation, operation and maintenance.
- Charge the battery within the specific temperature range because the low temperature may result in short circuit. Hence, do not charge the battery if the temperature is below the low limit of the operating temperature.
- Ensure that the packing cabinets are intact before unpacking. Do not use if package is damaged, and contact forwarder and manufacturer immediately.
- May leak electrolytes or release flammable gases if the battery is damaged, including dropping, crashing, bulging, or housing indentation. Do not use in the case of the above-mentioned circumstances. Please immediately contact the installer or professional operation and maintenance staff to remove or change the battery in the case of leakage of electrolytes or structural distortion. Keep the damaged battery away from other devices or inflammable and explosive materials, and ensure that non-professional personnel do not contact the damaged batteries.
- Ensure that the pungent and burning smells go away before operating.
- Do not place any objects, like tools, metal parts, etc., on top of the battery. Check and clean them up if any.
- Do not install batteries in rain, snow, fog, or other extreme weather, to prevent moisture or corrosion.
- Do not install batteries after moisturizing, transport to an isolation area, and be scrapped.
- Check if the shell of the battery is deformed or damaged before installing. If yes, do not install it.
- Check whether the positive and negative terminals of the battery are accidentally grounded. If yes, disconnect them.
- Do not weld or grind near the battery. Because an electric spark or arc may cause a fire.
- Store or recharge the battery according to the document if it is not used for a long time.
- The devices used to charge or discharge the batteries must meet the requirements of local laws, regulations, and standards.
- Power off the battery when installing and maintaining.
- Inspect the damaged battery to ensure that there is no smoke, fire, leakage of electrolytes, or heat in the period of storage.
- Do not touch the battery when it fails because of the high temperature of the surface.
- Do not step, against, or stand on the battery.
- The batteries are not allowed to be used to provide a backup power source in the following circumstances:
 - a. Medical device that is directly related to human health.
 - b. Device, like trains, elevators, etc., that may cause injuries to human beings.
 - c. Computer systems that play an important role in societies and institutions.
 - d. Nearby area with medical device.
 - e. Other devices that play a similar role, as described above.

NOTICE!

Short-circuit protection

- Use electrical tape to wrap the exposed cable outwards to prevent short circuit when installing and maintaining.
- Prevent any object from entering into batteries.

NOTICE!

In case the battery module leaks electrolyte or any other chemical materials, or gas may be generated due to the leakage of battery module, be sure to avoid contact with the discharge at all times. In case of accidentally coming into contact with them, please do as follows:

- In case of inhalation: Leave the contaminated area immediately, and seek medical attention at once;
- In case of contact with eyes: Rinse eyes with running water for 15 minutes, and seek medical attention;
- In case of contact with skin: Wash the contacted area thoroughly with soap, and seek medical attention;
- In case of ingestion: Induce vomiting, and seek medical attention.

NOTICE!

If a fire breaks out where the battery module is installed, please do as follows:

- In case the battery module is charging when the fire breaks out, provide it is safe to do so, disconnect the battery module circuit break to shut off the power charge;
- In case the device is not on fire yet, use a Class ABC fire extinguisher or a carbon dioxide extinguisher to extinguish the fire;
- If the battery module catches fire, do not try to put out the fire, and evacuate immediately.
- The battery module may catch fire when it is heated above 302°F/60°C; and in case of catching fire, it will produce noxious and poisonous gas, DO not approach and keep away.

NOTICE!

Effective ways to deal with accidents:

- In case of the damaged battery module, place it into a segregated place, and call the local fire department at the place where the user lives or qualified personnel.
- If any part of the battery module, or wiring is submerged, do stay out of the water and do not touch anything; If the battery module gets wet, don't touch it.
- If the battery module is damaged, don't use it. Otherwise, it may result in both personal injury and property damage.
- Don't use the submerged battery module again, and contact the qualified personnel

NOTICE!

Recovery of damaged or wasted battery:

- Dispose of the damaged or wasted batteries according to local laws and regulations instead of placing them in the household trash or in curbside recycling bins. Otherwise, it may cause environmental pollution or explosions.
- Contact our company or a battery recycling company to scrap the battery, if it leaks electrolytes, or is damaged.
- Contact a battery recycling company to scrap batteries if they are expired.
- Keep the damaged or wasted batteries away from high temperatures and direct sunlight.
- Ensure that the damaged or wasted batteries are not exposed to the following environments: high humidity, corrosion.
- Do not recycle the damaged or wasted batteries for a second use, and immediately contact a battery recycling company to scrap them. Or, it may cause environmental pollution.

1.4.3 Electrical Safety

 DANGER!

- Before wiring, check that the device is intact to prevent electric shock or a fire.
- Improper operation may cause a fire, electric shock, etc.
- Prevent any objects from entering into the device when operating. Otherwise, the device may be short-circuited or damaged, the load's power supply may be derated or powered off, or personal injuries may occur.

 WARNING!

- A device required to be grounding must be grounded firstly when conducting wiring. The PNGD cable must be disconnected finally after removing any other cables.

 CAUTION!

- Do not install cables near air inlet (or outlet) of the device.

NOTICE!

- Please strictly follow the steps described in the document before installing, operating and maintaining the device. Do not modify or change the device, and adjust the installation procedure.
- Permission shall be obtained from the state or local electrical department before conducting the grid connection.
- Abide by the safety regulations stipulated by the power station.
- Mark off an operation area, install a temporary fencing or rope, and put up "No Entry" signs.
- Power off the device and shut down switches before connecting or disconnecting power cables.
- Power off the device at once and do not use again if there are any liquids entering into it.
- Check and confirm whether the tools meet the requirements described in the document before operating the device, and be registered. Check whether the number of tools is correct after installing and operating it.
- Check that the icons on the cable labels are correct before connecting power cables. Ensure that the terminals are completely covered with insulation.
- Ensure that protective shell or insulation sleeving on the electrical components are correctly installed to protect operators from electric shock.
- In the case of multiple inputs, disconnect them first; do not operate the device until it is completely powered off.
- Turn off the corresponding output switch of the power supply device while maintaining electrical terminal device and power distribution device connected to the power supply device.
- Must put up "Do Not Switch On" signs and warning signs, to prevent power connection. Do not switch on before the fault is repaired.
- Must follow the steps below if the device needs a power cut in the process of fault diagnosis and troubleshooting: power cut > electricity testing > connecting grounding cable > putting up warning signs and installing guardrails.
- Periodically check whether the screws are tightened fully.
- Only professionals can change the damaged cables.
- Do not alter, damage or obscure the logos and labels attached to the devices.
- Do not clean the internal and external parts of the device with solvents, like water, alcohol or oil.

NOTICE!

Grounding requirement:

- The device grounding impedance shall meet the requirements of the local electrical code.
- The device shall be permanently connected to a grounding cable within the building's electrical system. Check that the device is reliably grounded.
- Do not operate the device before connecting it to the device grounding connector.
- Do not damage the device grounding connector.
- Make sure that the grounding pin in the 3 pin plug is connected to a grounding cable within the building's electrical system in the case of the 3 pin plug.
- In the case of high-current device, it shall be ensured that the protective grounding terminal of the device shell has been grounded.

NOTICE!

Wiring requirement:

- Must abide by the local laws, regulations and standards to select, install, and route cables.
- Do not circle or twist cables. Change the power cable if the cable length is insufficient instead of joining it.
- Make sure that cables are secured and well-insulated, and meet specifications.
- Cable troughs or holes must be smooth, burr-free working surface to prevent cable damage.
- Suggest to use cable ties to bind cables to ensure that the cables inside the cabinet are tidied, and to prevent cable jacket damage. Do not circle or twist cables.
- Use fireproofing mud immediately to seal the cable holes if you need to leave for a while after finishing wiring or in the process of wiring, to prevent water vapor and small animals.
- If the external conditions (routing method, temperature, etc.) change, the cable type must be verified according to IEC-60364-5-52 or local laws, regulations and standards. For instance, verify whether the cable ampacity meets the requirements.
- The cable insulation layer may be aging, and even damaged in a high temperature environment. Therefore, at least 30 mm of distance shall be kept between the cables and heater or periphery of heat sources.
- Do as follows to prevent cables from brittle cracking due to shocking or shaking in the low temperature environment, and ensure operation safety:
 - a. Handle gently when installing cables in a low temperature environment above 0°C.
 - b. Must move the cables indoors and leave them for more than 24 hours before installing them, if the previous storage temperature is below 0°C.
- Do not throw cables to prevent damage and deteriorate performance, such as current capacity, temperature, etc.

NOTICE!

The static electricity generated by human beings can damage the static-sensitive components on the board, like large scale integrated circuit. Therefore, please follow the steps below to prevent static electricity:

- Operators must wear anti-static clothing, and anti-static gloves or wrist straps before contacting the boards, modules with exposed circuit boards, or application specific integrated circuits (ASIC). If the anti-static wrist strap is used, hook up the metal clip that's on one end to a grounded and unpainted metal surface.
- Hold the circuit board or the modules with exposed circuit board by its edges without components. Do not contact the components.
- Use anti-static materials to pack the removed boards or modules before storage or transportation.

1.5 Safety Instructions of PV, Inverter and Grid

Save these important safety instructions. Failure to do so may result in damage to the inverter and injury or even loss of life.

1.5.1 Safety Instructions of PV

 **DANGER!**

Potential risk of lethal electrical shock associated with the photovoltaic (PV) system

- Exposure to sunlight can result in the generation of high DC voltage by PV modules, which can lead to electric shock causing severe injuries or even death.
- Never touch the positive or negative poles of the PV connecting device, and avoid touching both poles simultaneously.
- Do not ground the positive or negative poles of the PV modules.
- Only qualified personnel can perform the wiring of the PV modules.

 **WARNING!**

- Overvoltage protection with surge arresters should be provided when the PV system is installed. The grid connected inverter is fitted with SPDs on both PV input side and MAINS side.
- Please consult professionals before installing SPDs.

 **WARNING!**

- Make sure that the input DC voltage does not exceed the maximum DC input voltage specified for the inverter. Overvoltage can cause irreversible damage to the inverter, and such damage is not covered by the warranty.
- PV modules should have an IEC61730 class A rating.

1.5.2 Safety Instructions of Inverter

DANGER!

Potential risk of lethal electrical shock associated with the inverter

- Only operate the inverter if it is in a technically faultless condition. Operating a faulty inverter may lead to electric shock or fire.
- Do not attempt to open the enclosure without authorization from SolaX. Unauthorized opening of the enclosure will void the warranty and can result in lethal danger or serious injury due to electric shock.
- Make sure that the inverter is reliably grounded before any operation to prevent the risk of electric shock causing lethal danger or serious injury.
- Only qualified personnel can perform the installation, wiring, maintenance of the inverter by following this document and the related regulations.

DANGER!

- Prior to any wiring connection, establishing an earth connection is essential.

WARNING!

- During operation, avoid touching any parts of the inverter other than the DC switch and LCD panel.
- Never connect or disconnect the AC and DC connector while the inverter is running.
- Prior to conducting any maintenance, turn off the AC and DC power and disconnect them from the inverter. Wait for 15 minutes to fully discharge the energy.

WARNING!

Potential danger of scalding due to the hot enclosure of the inverter

- Avoid touching the inverter while it is running, as it becomes hot during operation and may cause personal injuries.

WARNING!

- When handling the battery, carefully follow all safety instructions provided in the battery manual. The battery used with the inverter must meet the specified requirements of the series inverter.

CAUTION!

- Make sure that children are supervised to prevent them from playing with the inverter.
- Pay attention to the weight of the inverter and handle it properly to avoid personal injuries.
- Use insulated tools when installing the device, and always wear personal protective equipment during installation and maintenance.

NOTICE!

- The inverter has an integrated Type-B Residual Current Monitoring Unit (RCMU). If an external Residual Current Device (RCD) is required by local regulations, verify the type of RCD required. It is recommended to use a Type-A RCD with a rating of 300 mA unless a lower value is required by the specific local electric codes. When required by local regulations, the use of an RCD type B is permitted.
- Keep all product labels and the nameplate on the inverter clearly visible and well-maintained.

1.5.3 Safety Instructions of Utility Grid

NOTICE!

- Only connect the inverter to the grid with the permission of the local utility grid company.

2 Routine Maintenance

2.1 Preparations Before Maintenance

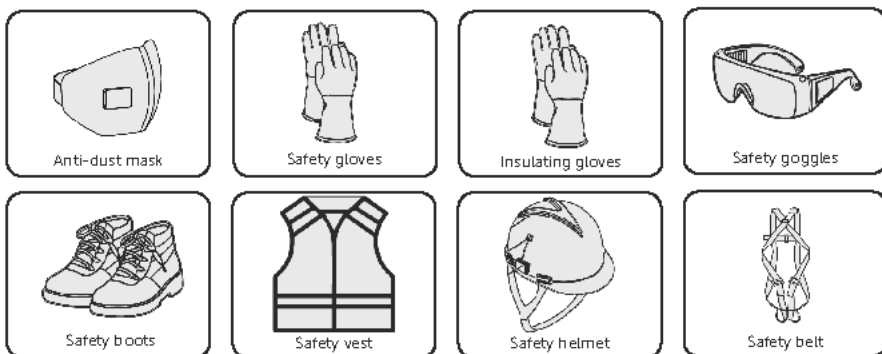

* This section only lists protective equipment, please refer to the appropriate section for specific replacement tools.

2.2 Routine Maintenance

Regular maintenance is required for the device. Please follow the instructions below to inspect and maintain the system. We recommend maintaining the system once a year, and more frequent maintenance service is needed in the worse work environment. Please make records of the maintenance.

Prerequisites

- Tools: Cross screwdriver, torque wrench, ladder.

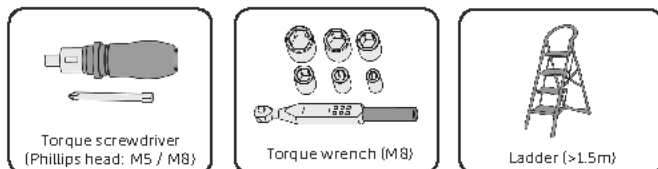

Procedure

Step 1: Patrol the system round, checking the following items in turn:

Check item	Description
Operating environment	Check whether there are debris, flammable and explosive materials, toxic and harmful substances accumulating near the system. If so, please remove them.
System appearance	<ul style="list-style-type: none"> • Check whether there is any damage or deformation in the system. • Check whether there are scratches, stubborn stains, dents or dings on the surface of the cabinet. If there is any paint loss, please repaint the cabinet (please refer to the user manual for specific procedure) • Check whether the antenna is rusty due to salt spray, if so, the antenna needs to be replaced, for detailed replacement procedures, please refer to "5 Replacement of Antenna".
Operating status	Check whether there is any abnormal noise or odour in the running system.
Cabinet ventilation	Check whether the air inlet and outlet and drainage port of the cabinet are blocked, if there is any blockage, please clear it.

Step 2: Check the cabinet screen for the following items:

Check item	Description
Screen display	Check whether the screen is displaying properly.
Alarm information	View alarms on the cabinet screen, for details, see "3.1 Cabinet Screen".
System operation mode	Check whether the system is charging and discharging normally according to the modes set up by checking the historical data of the battery cells, inverters, and so on.

Step 3: Power off the system, for details of the power off procedure, see "2.3 Power Off".

Step 4: Open the cabinet door, checking the following items:

NOTICE!
<ul style="list-style-type: none"> • Please gently open the door to prevent raising dust from the filter cotton. Otherwise, the smoke detector will alarm and give a command to the automatic fire sprinkler to spray gas.

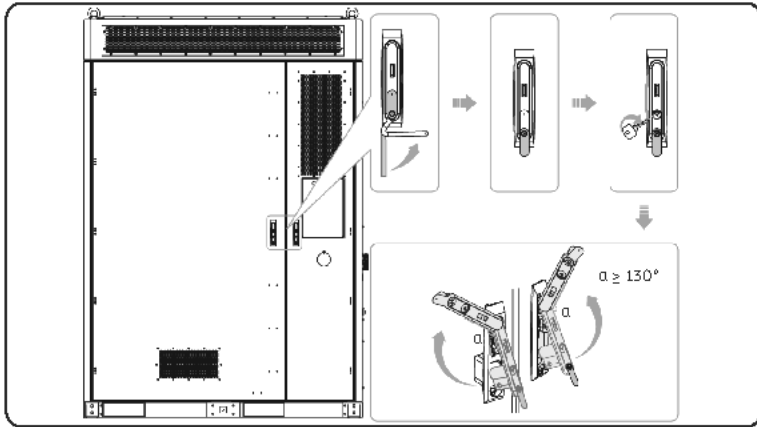

Figure 2-1 Opening front doors

Check item	Description
Safety inspection	<ul style="list-style-type: none"> • Check whether the cabinet opens and closes smoothly and can be locked properly. If the door does not open and close smoothly, please use rust remover WD40 on the hinge. • Check whether the sealing strip of the cabinet is detached, broken or aged, if so, please replace the sealing strip.
Cabinet internal environment	<ul style="list-style-type: none"> • Check whether there is any obvious debris or construction leftovers inside the cabinet, if so, please make cleaning. • Check the cable threading holes for fireproof mud to ensure that they are sealed reliably and that no small animals enter the cabinet. • Check the inside of the cabinet and the battery compartment air-conditioning return vents for water leakage or traces of water leakage. If water leakage is found, please contact SolaX professionals for treatment.
Parts appearance	<p>Check the appearance of the inverter, battery packs, air conditioner, smoke detector, temperature sensor, CO detector, UPS, EMS1000, I/O module and distribution box for damage, distortion, or soiling.</p>
Electrical connection	<ul style="list-style-type: none"> • Check the electrical connection of battery packs, inverter, distribution box and EMS for looseness and cable jacket damage, especially the cable jacket connecting with the metal parts. • Check whether each cabinet has at least two grounding points, and the grounding is secure, the use of grounding resistance tester, measuring resistance $\leq 0.1\Omega$ • Check whether the sealing caps on idle terminals of inverter are falling off. • Check whether the electrical insulation tape is in good condition and no peeling. • Check whether there is any fading to the screws and copper bars.

Check item	Description
SPD status	Check the status window on the SPD, if the status window is red, the SPD needs to be replaced.
Aerosol	Check the appearance of the aerosol: no deformation and nozzle integrity, confirm no agent leakage
Battery pack	<ul style="list-style-type: none"> • Check the appearance of each battery pack to make sure that there is no damage, deformation, and odour. • Open the left cover of the battery pack, remove the cover of positive and negative poles, check whether the glass fibre sleeve on the outside of the copper bar is broken, whether there is obvious deformation of the copper bar/cable, and whether there is no discolouration of the screws and the exposed part of the copper bar, and if there is any abnormality, please replace them in time. • Open the left cover of the battery pack, remove the cover of positive and negative poles, check whether the screws of cables and copper bars are loosened, whether there is any abnormality of the poles, if there is any loosening, please tighten the screws with a torque wrench (torque: 12.0 ± 1 N.m), and contact SolaX to confirm the reason in time. • Check whether there is dust accumulation in the battery pack fan. If there is dust accumulation, please clean it up. If the dust accumulation is serious, the fan can be removed and cleaned up or replaced with a new one. • Check whether there is rust on the connection between the battery pack lugs and the battery pack, if rust is found, use sandpaper to polish the rust. • Open the right rotating cover of the slave control, check whether the cable harness is loose and whether the cable jacket is damaged. If there is any looseness, please tighten the cables, and if the cable jacket is damaged, please replace it, and contact SolaX to confirm the reason.

Step 5: System power on, for details of the power on procedure, see "2.4 Power On".

Step 6: Open the cabinet door, checking the following items:

Check item	Description
Parts operating status	<ul style="list-style-type: none"> • Check whether there is any abnormal noise when the inverter, battery packs, distribution box, air conditioner and UPS are in operation. • Check whether the indicator of distribution box, EMS and I/O module lights normally.
Explosion-proof fan	<ul style="list-style-type: none"> • Use EMS D04+ to control the start-up of the explosion-proof fan. (This function is only available for admin account.) When the explosion-proof fan rotates, it makes a sound which is normal for exhaust air. If the explosion-proof fan does not rotate, it is abnormal. In such cases, the explosion-proof fan needs to be replaced.

Check item	Description
Safety function	<ul style="list-style-type: none">• Press the emergency stop button to check whether the AC circuit breaker can be disconnected, and the audible and visual alarms will sound for alarm prompting, and whether the LED indicator is displayed normally.• Check the stopping signal and communication by simulating the shutdown operation.• Check whether there are any damages to warning signs and other labels pasted on the equipment. If so, please replace them in time.

Step 7: After completing the daily maintenance, please close the door.

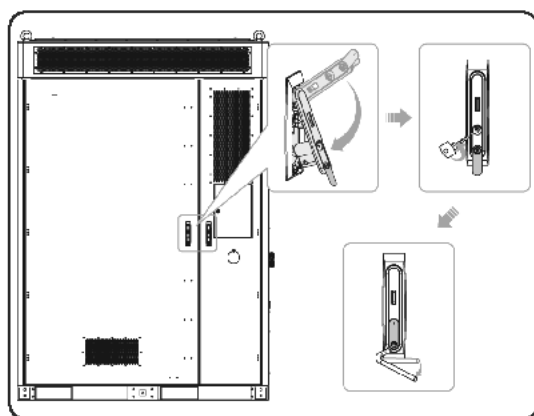

Figure 2-2 Closing the door

NOTICE!

- Please properly keep the key.

2.3 Power Off

Regarding the detailed location of the modules in the cabinet, see following figure.

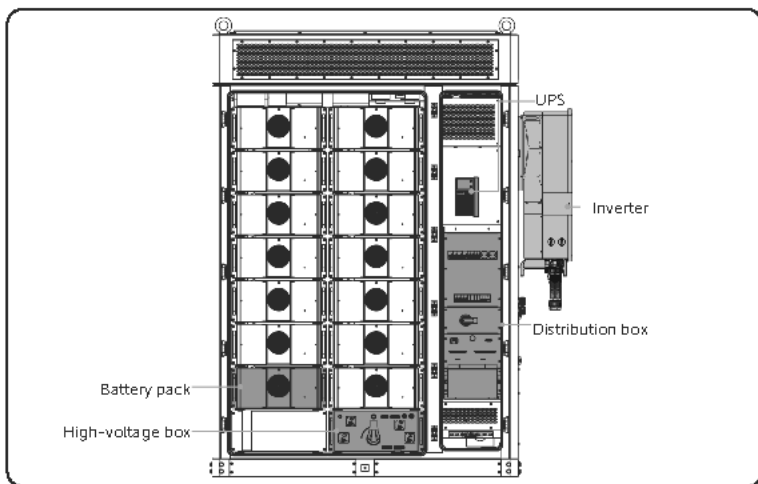

Figure 2-3 Location of modules

⚠ WARNING!

- Check whether the system is still running before power off. Do not power off if the device is "under load".

Step 1: Open the front doors.

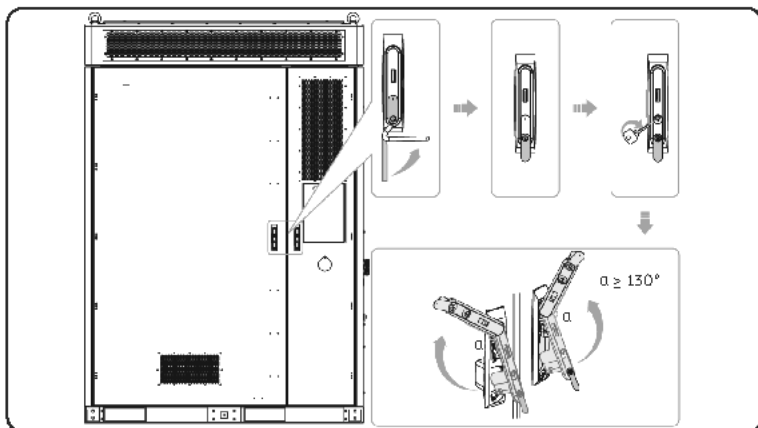

Figure 2-4 Opening front doors

Step 2: Inverter power off.

- Set **OFF** in the **System ON/OFF** on the inverter LCD screen.
- Turn off the inverter system button.
- Set the DC switch1 and DC switch2 to "OFF".

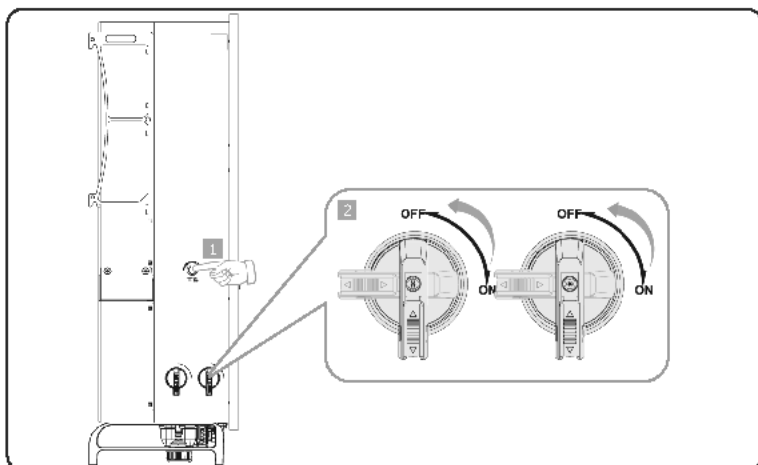

Figure 2-5 Shutting down the inverter

Step 3: Gently press the power button, and rotate the switch of the high-voltage box to "OFF".

Figure 2-6 Shutting down the high-voltage box

Step 4: Shut down the distribution box.

- » Flip down the "SPD MCB" breaker;
- » Flip down the "HVAC MCB" breaker;
- » Flip down the "EPS" breaker;
- » Flip down the "APS" breaker;
- » Flip down the "UPS" breaker;
- » Rotate the switch on the distribution box 90° counter-clockwise to "OFF".

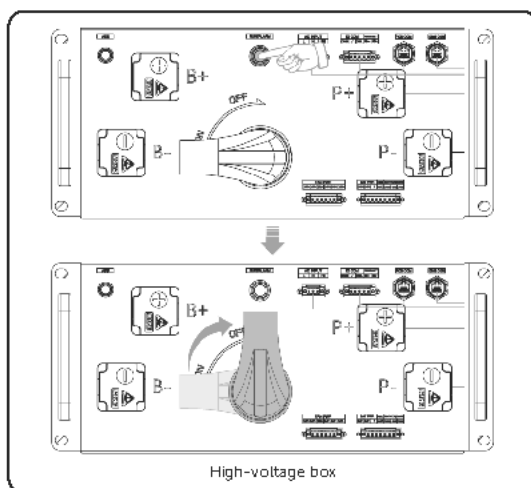
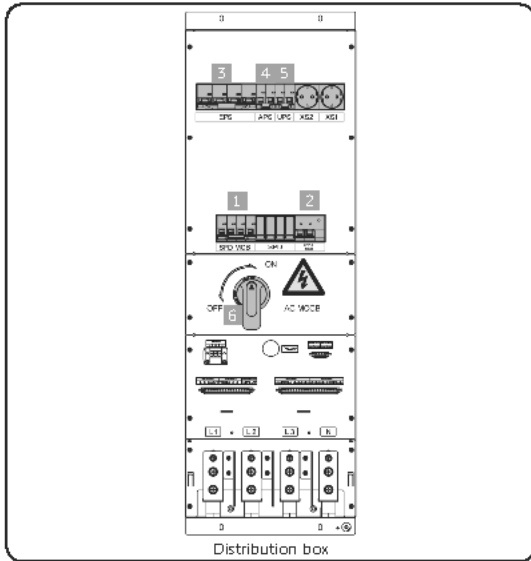

Figure 2-7 Shutting down sequence of distribution box

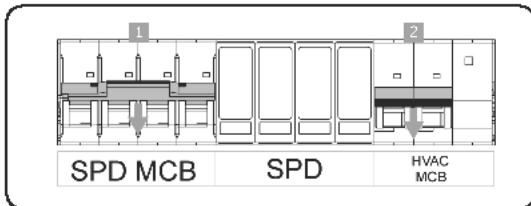

Figure 2-8 Flipping down breakers

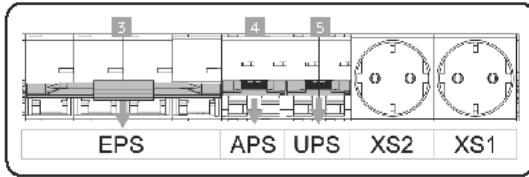

Figure 2-9 Flipping down breakers

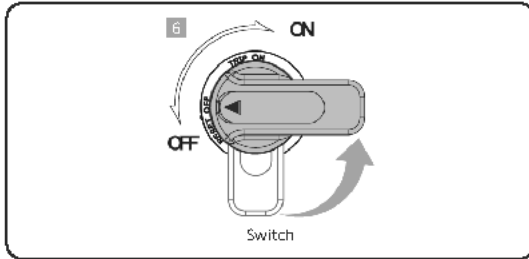

Figure 2-10 Rotating switch

Step 5: Hold and press the "Power on/off" button to power off the UPS.

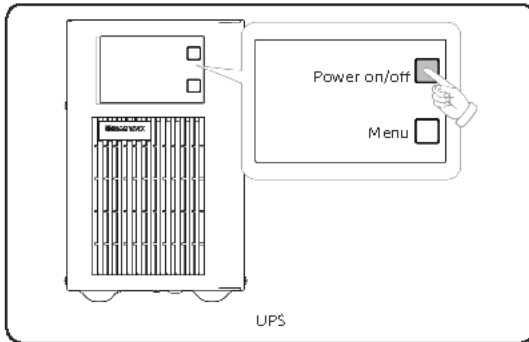

Figure 2-11 Holding and pressing button

⚠ WARNING!

- The device may still have power and heat after turning off, which may cause electric shock and personal injuries. Therefore, please allow it to cool for at least 15 minutes and wear PPE before conducting maintenance.

Step 6: Close the front door.

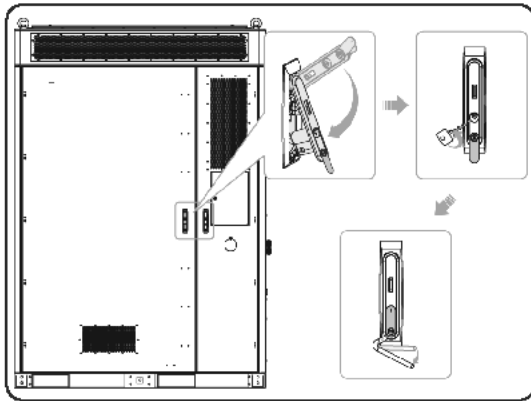

Figure 2-12 Closing the door

Emergency Power Off



- Do not press the emergency stop button except for emergencies.
- Some modules inside the cabinet may still have power after pressing the emergency stop button, therefore, non-professionals are not allowed to operate them.

Step 1: Rotate the cover

Step 2: Press the emergency stop button.

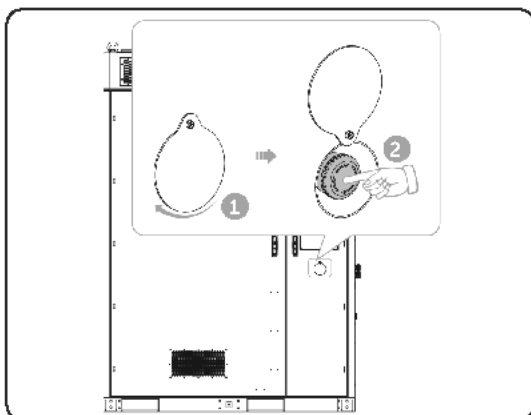

Figure 2-13 Pressing emergency stop button

NOTICE!

If it has been pressed, the emergency stop button must be reset before starting the device. The reset steps are shown as follows:

- a. Rotate the cover;
- b. Rotate the button according to the arrow direction shown on the button. Then the button will spring back to its original position.

2.4 Power On

Checking before power on

Ensure that all the cables connecting to the EPS and distribution box (grid side) are cabled and securely fastened. For details, please refer to the following table.

Table 2-1 Checklist

No.	Item	Description
1	Equipment appearance	<ul style="list-style-type: none"> • Check the equipment is in good condition, with a clean, non-peeling paint, and rust-free surface. • Ensure that the labels on the equipment are clear and easy to read. If it is damaged, the label shall be replaced at once.
2	Installation	<ul style="list-style-type: none"> • The battery cabinet, inverter and other device (if any) are installed correctly and securely. • All the screws are tightened.
3	Cable appearance	<ul style="list-style-type: none"> • Check that the cable jacket is in good condition. • Check that the protective pipes are in good condition.
4	Cable connection	<ul style="list-style-type: none"> • Check that the cable connection position is consistent with the design principles. • Ensure that the procedure for crimping terminals strictly observe the requirements, and the terminals are securely fastened. • Check that the labels on the both sides of cables are clear, and the direction of both labels is the same. • Check that all DC, AC cables, ground cable, communication cables and meter/CT of the inverter are connected correctly and securely • Check that the external AC and DC connectors are connected; The connectors on the Grid and EPS terminal are connected correctly and securely. • Check the unused terminals and ports of the inverter are locked by waterproof caps. • Check that all photovoltaic panels are connected correctly and securely.

No.	Item	Description
5	Wiring	<ul style="list-style-type: none"> • Ensure that the wiring procedure is consistent with the principle of separation of strong and weak electricity. • Ensure that the cables are neatly placed. • Leave a little extra length for adjustments. • Keep cables tidy in the cabinet. • Check if the grid connection voltage meets: L1+N=220/230 V, L2+N=220/230 V, L3+N=220/230 V, L1+L2=380/400 V, L2+L3=380/400 V, L1+L3=380/400 V.
6	Copper bars in the battery pack	<ul style="list-style-type: none"> • Check to make sure the copper bars are not deformed.
7	Button/Switch	<ul style="list-style-type: none"> • Check the distribution box's switch is "OFF". • Check the high voltage box's switch is "OFF". • All the DC breakers and AC breakers are "OFF"

Power on procedure

Regarding the detailed location of the modules in the cabinet, please refer to "Figure 2-3 Location of modules".

NOTICE!

- Please check that the emergency stop button remains in the closed position before powering on.

Step 1: Start the distribution box.

- » Rotate the switch on the distribution box 90° clockwise to "ON";
- » Flip up the "SPD MCB" breaker;
- » Flip up the "HVAC MCB" breaker;
- » Flip up the "EPS" breaker;
- » Flip up the "APS" breaker;
- » Flip up the "UPS" breaker.

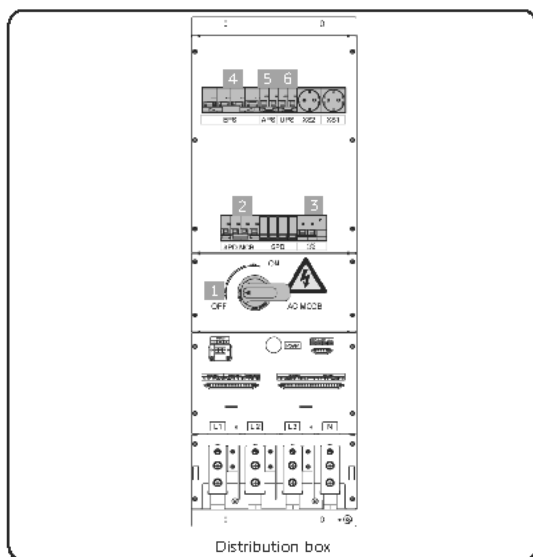

Figure 2-14 Starting sequence of distribution box

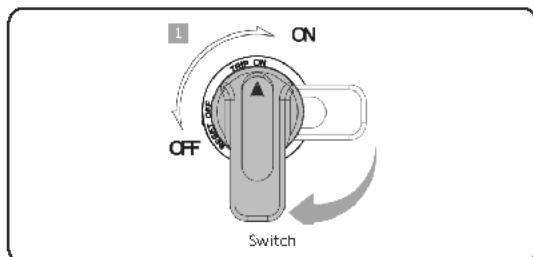

Figure 2-15 Rotating switch

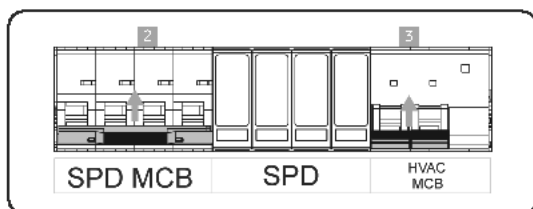

Figure 2-16 Flipping up breakers

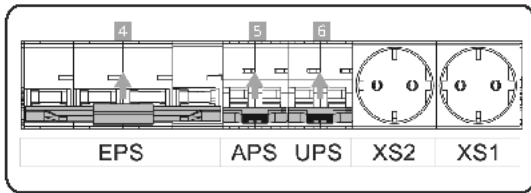

Figure 2-17 Flipping up breakers

Step 2: Start the inverter.

- a. Switch on the inverter DC switch and check the LCD screen, check the PV voltage.
 - » If the PV voltage is 0, turn off the DC switch, pull out the PV connectors and then measure the voltage of the positive and negative PV port (in MPPT voltage range 160-950 V) or check whether the positive and negative poles of PV cables are reversed.
- b. Press and turn on the inverter system button.

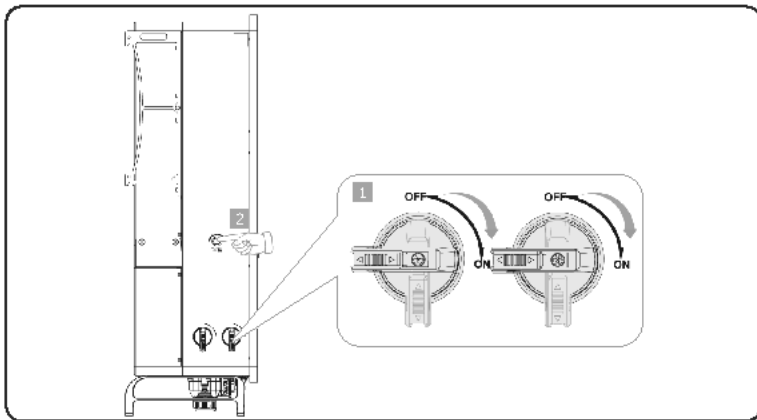

Figure 2-18 Starting the inverter

- c. Set **System ON/OFF** as ON status on the inverter screen, and the LCD displays waiting status.
- d. When the photovoltaic panels generate enough power or the battery supplies power, the inverter will start automatically. The inverter will go Waiting, Checking and Normal status in sequence.
- e. Check whether the meter/CT is correctly connected.
 - » If CT is connected, please perform the Meter/CT Check to check the correct connection through the setting path: **Menu>Setting>Advance Setting>Meter/CT Settings>Meter/CT Check**

- » If meter is connected, please set the connection of Meter through the setting path: **Menu>Setting>Advance Setting>Meter/CT Settings.**

NOTICE!

- When the meter or CT is correctly connected, the meter/CT power displays on the METER/CT check interface; when the connection method is wrong, **Meter Fault** displays on this interface.

Step 3: The startup sound on boot will be heard when holding and pressing the "Power on/off" button to start the UPS.

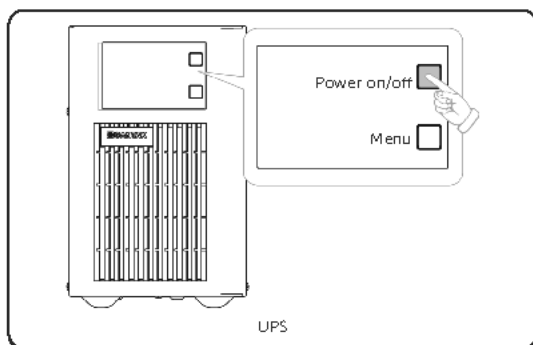

Figure 2-19 Holding and pressing button

Step 4: Rotate the switch of the high-voltage box to "ON", and then gently press the power button. At the point, the LED light will come on green.

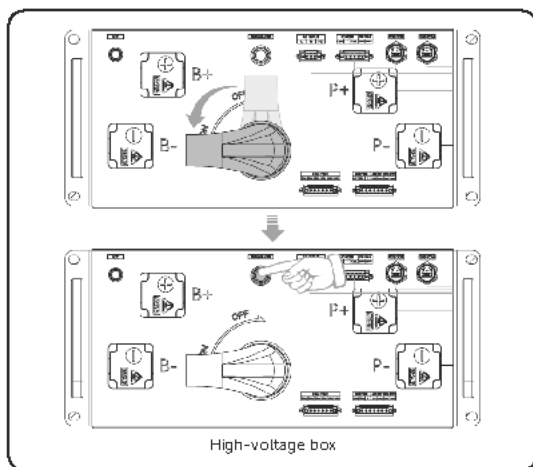

Figure 2-20 Starting the high-voltage box

Step 5: Close the door after the device has been started.

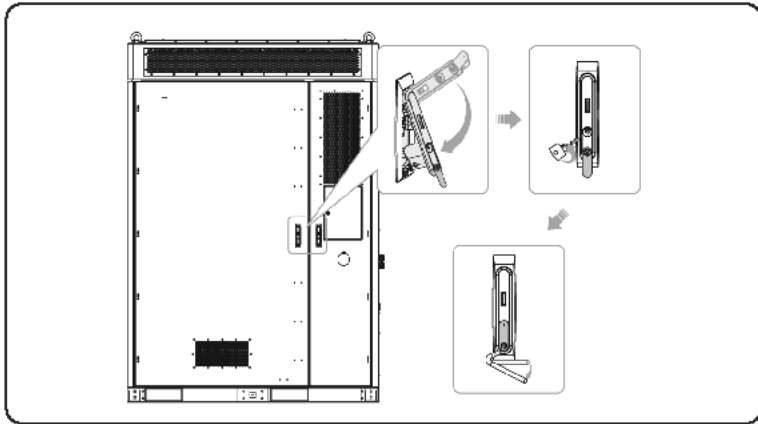

Figure 2-21 Closing the door

NOTICE!

- Please properly keep the key.

Checking after power on

- a. Check whether the system has any abnormal noise.
- b. Check whether the indicator lights report an error and check the system for alarm through the cabinet screen
- c. Check the running status of the system through the cabinet screen.

3 Alarm Reference

System alarms can be viewed through the following channels: cabinet screen, EMS1000 webpage, SolaXCloud APP, please handle alarms according to the suggestions.

3.1 Cabinet Screen

3.1.1 Logging in

Gently and correctly guide the key (Part R) into the keyhole, and then turn it clockwise to unlock the screen door.

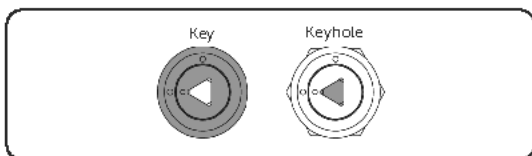

Figure 3-1 Correct position

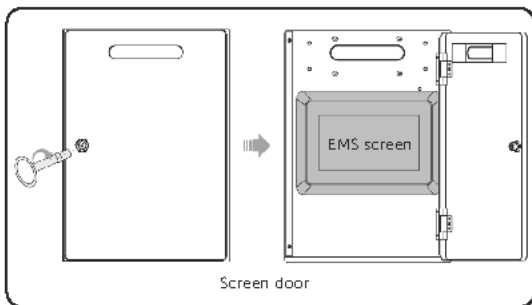

Figure 3-1 Unlocking screen door

On the login screen, enter the username and password, and then tap **Login**.

Admin and user accounts are supported.

Table 3-1 Account information

Username	Password	Remarks
Admin	EMS SN	The password cannot be modified
User	123456 by default	The password can be modified on EMS1000 webpage.

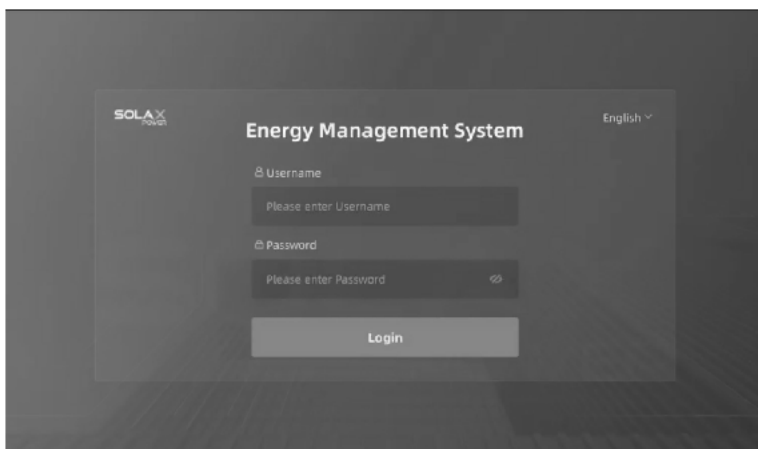

Figure 3-2 Logging in to the screen

3.1.2 Viewing Alarms

Alarm information includes the device name and type, error code, alarm name, alarm level, time that the alarm occurs and stops, alarm status and more.

Log in to the webpage, and then select **Alarm**.

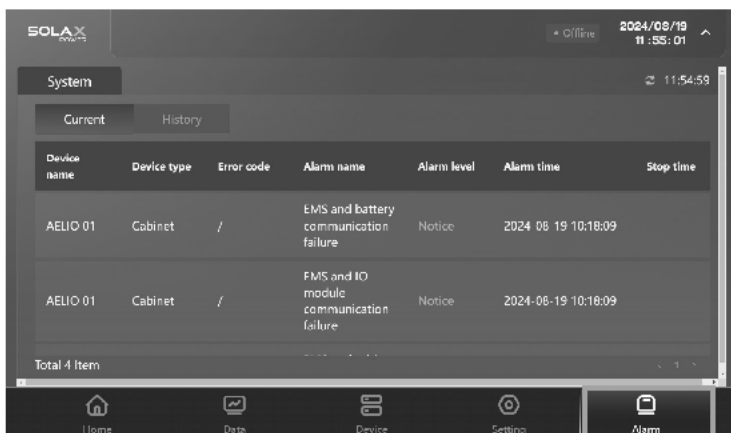

Figure 3-3 Logging in to the screen

Table 3-2 Alarm information description

Parameter	Description
Device name	Brief description of the device
Device type	The device with which the alarm occurs
Error code	Only available for inverter errors
Alarm name	Brief description of the alarm
Alarm level	Emergency urgency level of the alarm, divided into critical, warning and notice
Alarm time	Time that the alarm occurs
Stop time	Time that the alarm is resolved
Operation	Click Detail to view to view more details on the alarm.

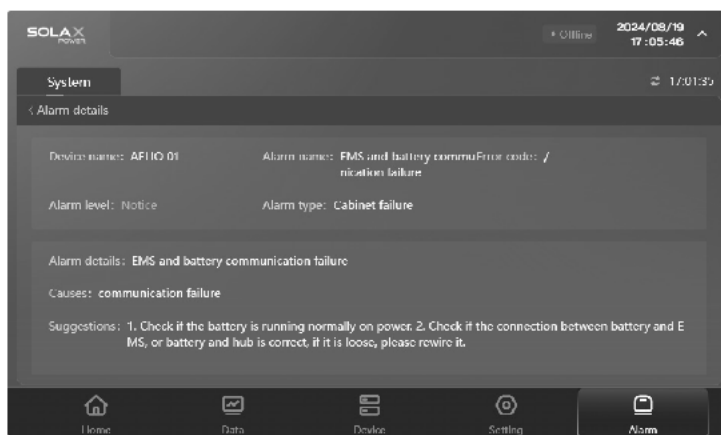

Figure 3-4 Alarm details

3.2 EMS1000 Webpage

NOTICE!

Screenshots of V002.05 software are used for example in this chapter, and the actual page details might vary.

3.2.1 Logging in

NOTICE!

IE browser is not supported currently, and we recommend logging in to the webpage through Chrome.

Step 1: Connect the computer to NET2 of EMS1000 with a network cable, or connect the computer to EMS1000 hotspot named WiFi_SN, and then go to the defined IP address based on the connection mode.

- » For cable connection: **192.168.11.10**
- » For hotspot connection: **192.168.10.10**

Step 2: On the login page, select the language, enter the username and password, and then click **Login**.

The default username and password for the user account are user and 123456.

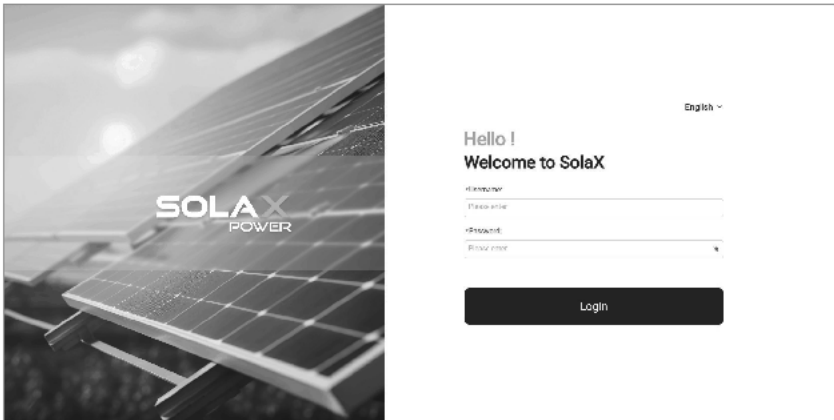

Figure 3-5 Login page

3.2.2 Viewing Alarms

Alarm information includes the device type and SN, alarm name, error code, alarm level, time that the alarm occurs and ends, alarm status and more.

Log in to the webpage, and then select **Alarm info**.

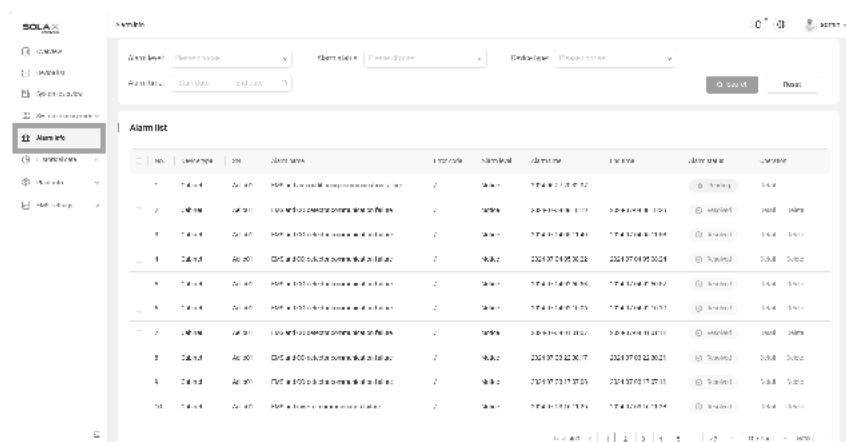

Figure 3-6 Viewing alarm information

Table 3-3 Alarm information description

Parameter	Description
Device type	The device with which the alarm occurs
SN	SN of the alarm device
Alarm name	Brief description of the alarm
Error code	Only available for inverter errors
Alarm level	Emergency urgency level of the alarm, divided into critical, warning and notice
Alarm time	Time that the alarm occurs
End time	Time that the alarm is resolved
Alarm status	<ul style="list-style-type: none"> Pending: Alarms that are not resolved yet Resolved: Alarms that have been resolved

You can click **Detail** under **Operation** on each alarm to view more details on the alarm, and the possible causes and suggestions that we offer for each type of alarm. This helps you to solve the problem quickly and efficiently.

3.3 SolaXCloud App

3.3.1 Downloading and Installing App

Scan the QR code below to download SolaXCloud APP. You can also find the QR codes at the bottom right of the login page of www.solaxcloud.com or on the user manual of Pocket series communication module. In addition, you can search with the key word SolaXCloud in Apple Store or Google Play to download it.



Figure 3-7 QR code

Please watch the video or read the document on the SolaXCloud App for relevant operation.

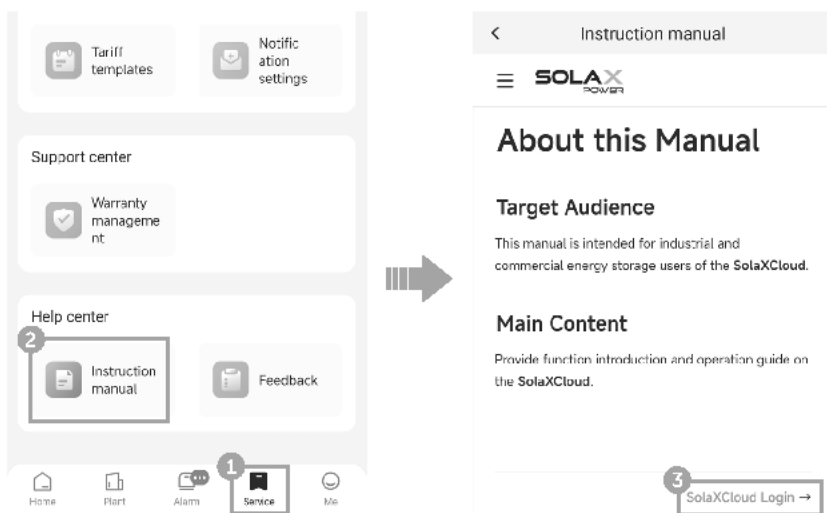

Figure 3-8 App guide on SolaXCloud

Please follow the steps below to view alarm information.

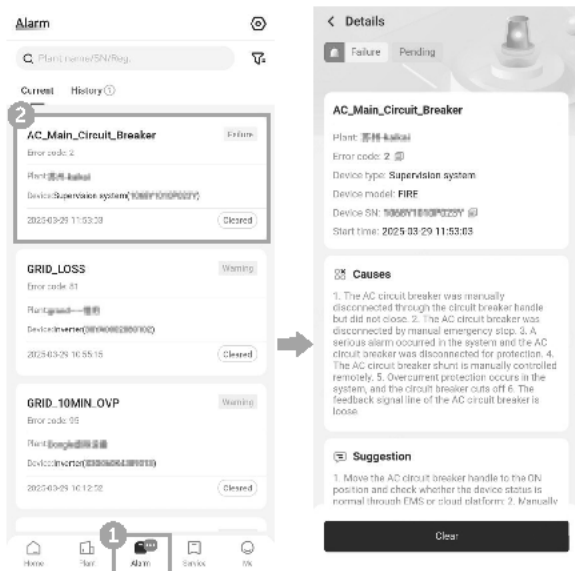

Figure 3-9 Viewing alarm information

NOTICE!

- The screenshots in this chapter correspond to the SolaXCloud App V6.6.0.

4 Disassembly and Clean of Air Conditioner Filter

Prerequisites

- Tools: Hexalobular key, Ladder (>1.5m).

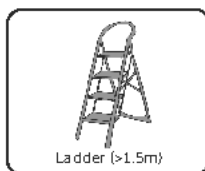
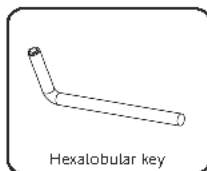

WARNING!

- The system must be powered off before disassembly and clean of air conditioner.
- The device may still have power and heat after turning off, which may cause electric shock and personal injuries. Therefore, please allow it to cool for at least 5 minutes and wear PPE before conducting maintenance.

Procedure

- Step 1:** Unscrew M6 screws, and orderly dismantle aluminum mesh plate and black filter.

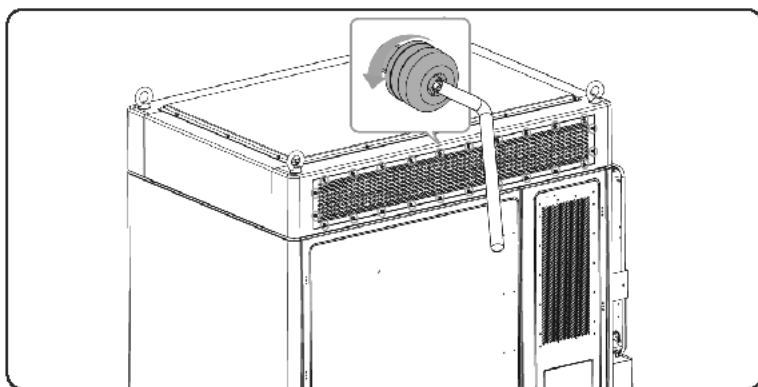

Figure 4-10 Unscrewing M6 screws

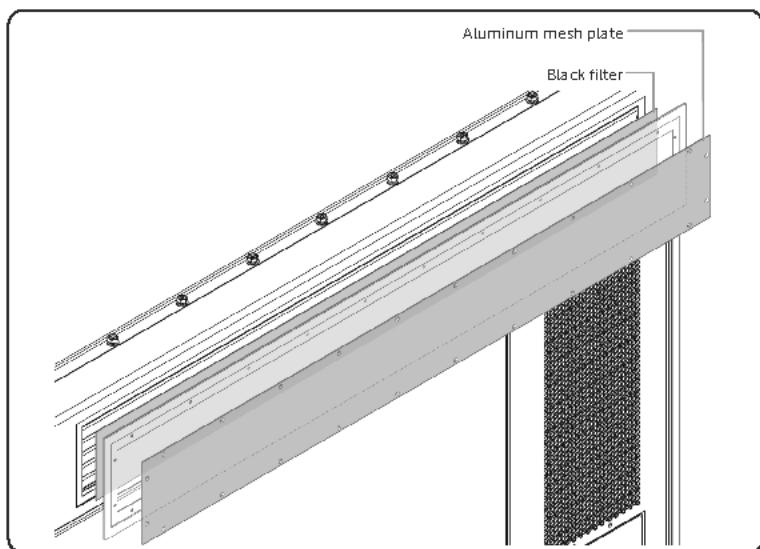

Figure 4-11 Dismantling aluminum mesh plate and black filter

- Step 2:** Clean aluminum mesh plate and replace the black filter.
- Step 3:** Orderly reinstall the black filter and aluminum mesh plate.
- Step 4:** Insert and tighten M6 screws (x 24).

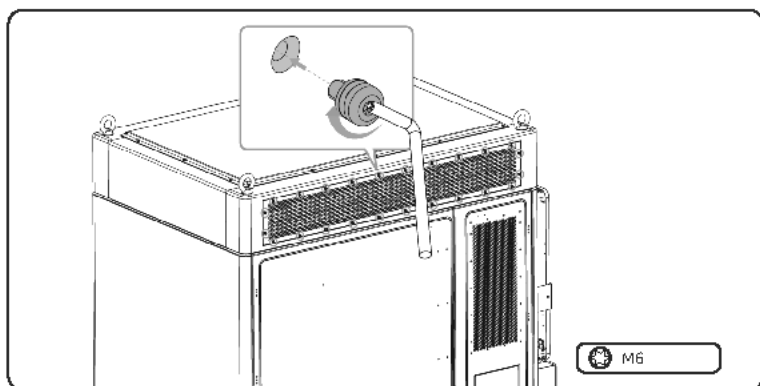
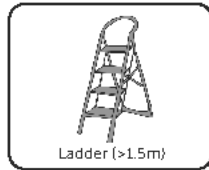

Figure 4-12 Tightening M6 screws

5 Replacement of Antenna

Prerequisites

- Tools: Ladder (>1.5m).



WARNING!

- The system must be powered off before replace the antenna.
- The device may still have power and heat after turning off, which may cause electric shock and personal injuries. Therefore, please allow it to cool for at least 5 minutes and wear PPE before conducting maintenance.

NOTICE!

- There are two antenna ports on the rear side of the cabinet. The left one shall be connected to an antenna, and the right one is a reserved port. The user can decide whether the reserved port connects an antenna based on the actual situation.

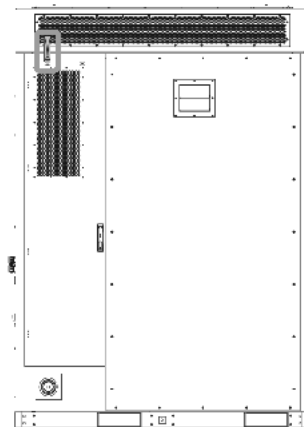

Figure 5-1 Position of the antenna (rear view)

Procedure

Step 1: Rotate counterclockwise and remove the antenna.

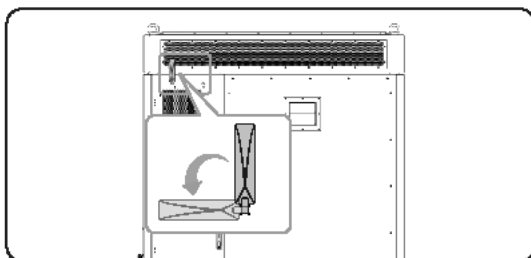

Figure 5-2 Removing antenna

Step 2: Correctly insert and tighten the antenna by turning it clockwise.

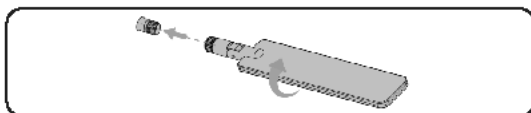

Figure 5-3 Installing antenna

Step 3: Fold the antenna up 90°.

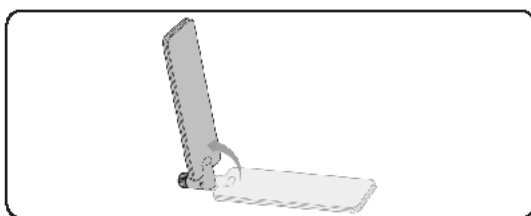

Figure 5-4 Folding the antenna

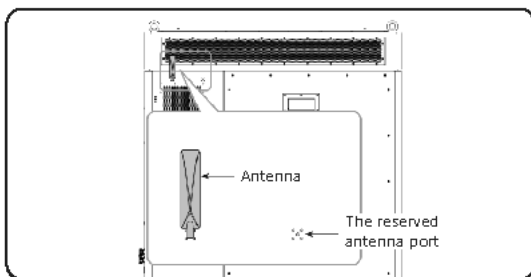
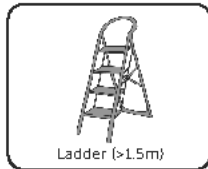
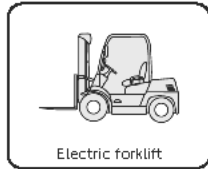
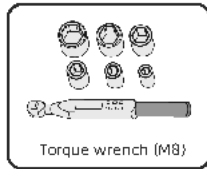
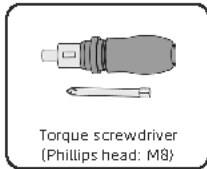

Figure 5-5 Well installed antenna

6 Replacement of Battery Pack

Prerequisites

- Fault locating:
 - a. View alarm information via cabinet screen, EMS1000 webpage or SolaXCloud App.
 - b. Refer to the alarm handling suggestions in the alarm details.
 - c. Contact SolaX and order replacement parts.
- Tools: Cross screwdriver, torque wrench, electric forklift, ladder.



- At least four persons are required to replace the component.

DANGER!

- Do not disassemble the battery violently. Otherwise, it may lead to battery pack short circuit, damage to the device (leakage, rupture), fire or explosion.

WARNING!

- Before replacing the battery pack, ensure that the system is powered off. Otherwise, electric shocks may occur.
- After the system powers off, there will still be the remaining electricity and heat which may cause electric shocks and body burns. Please wear personal protective equipment (PPE) and begin servicing the system 15 minutes after power off.
- Only qualified person can perform the maintenance for the device.

 WARNING!

- Before transportation, check that the battery package is intact and that there is no abnormal odor, leakage, smoke, or sign of burning. Otherwise, the batteries cannot be transported.
- Handle gently when moving the battery pack to prevent bumping or damage.
- Before moving a faulty battery pack (with scorch, leakage, bulge, or water intrusion), insulate its positive and negative terminals, pack it, and place it in an insulated explosion-proof box as soon as possible. Record information such as the site name, address, time, and fault symptom on the box.
- Keep away from flammable material storage area, residential areas, and other population centers (e.g., public transport, elevators) when transporting the faulty battery pack.

 WARNING!

- Before unpacking the battery, check whether the package is intact, batteries with damaged packaging should not be used, please notify the transporter and the manufacturer immediately if it is damaged.
- Before installing the battery pack, inspect the battery pack shell for deformation or damage.
- After removing the package from the battery pack, the installation must be completed within 24 hours, if it cannot be installed in time, the battery needs to be repacked and placed in an indoor, dry, non-corrosive gas environment; after completing the installation of the energy storage system, it must be powered on within 24 hours; the unpacking of the batteries to the powering on of the energy storage system needs to be completed within 72 hours, and the power off time can not be more than 24 hours for the later regular routine maintenance.

NOTICE!

- The expenses for dispose of the wasted or damaged battery packs incurred shall be borne by the user.

NOTICE!

- The replaced devices should be sent back to the local SolaX warehouse.

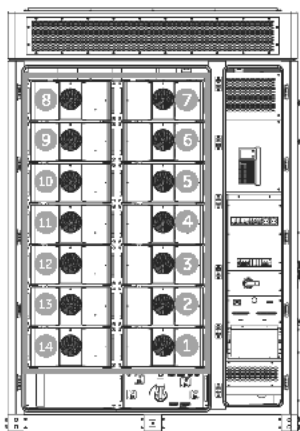

Figure 6-1 Position of the battery packs

Procedure

NOTICE!

- This section takes the replacement of battery pack 4 as an example.

Step 1: Press to open the covers on both sides of the battery pack to be replaced and the adjacent battery packs.

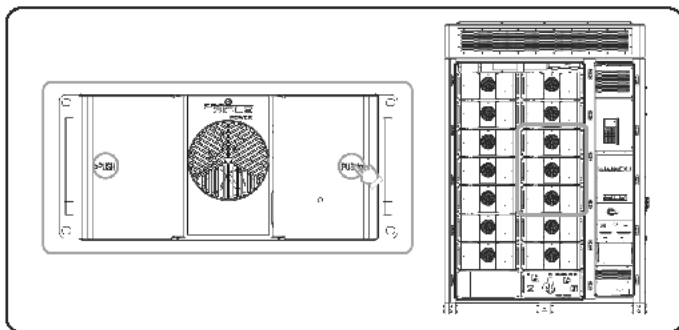

Figure 6-2 Opening the battery pack cover

Step 2: Remove the copper bars and cables.

1. Remove the terminal cover. Unscrew the M8 nut and remove the negative copper bar, reinstall the terminal cover.
2. Remove the positive copper bar in the same way.

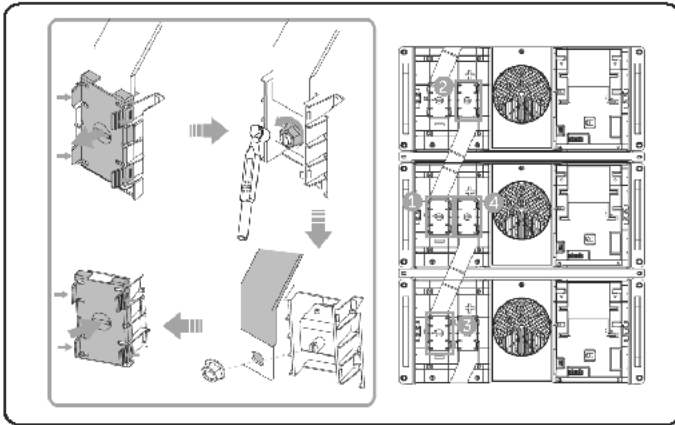

Figure 6-3 Removing the copper bars

 **WARNING!**

- After removing the copper bars, it is necessary to install the covers back, otherwise electric shock may occur.

3. Remove the fan power cables and communication cables of the battery pack.

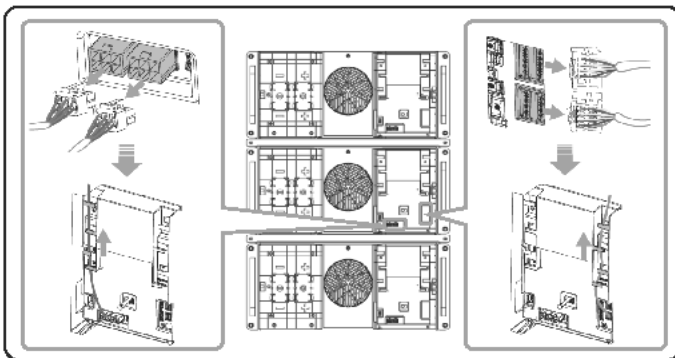

Figure 6-4 Removing the cables

Step 3: Unscrew the M8 screws on the battery pack.

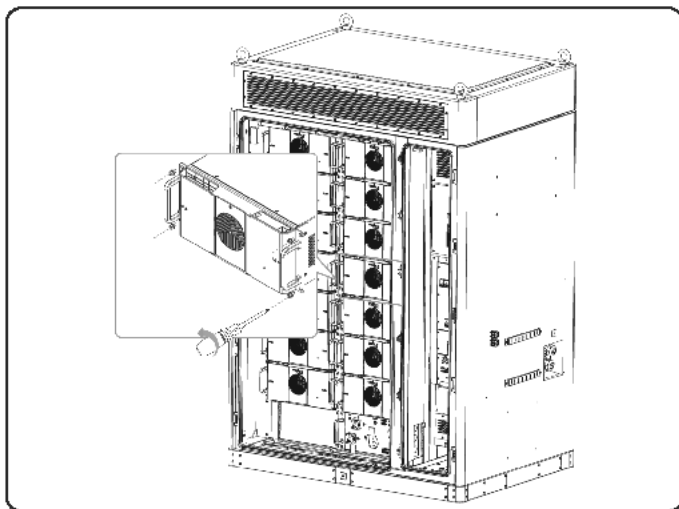

Figure 6-5 Removing screws on the battery pack

Step 4: Draw the battery pack onto a forklift and transport it with the forklift.

Step 5: Transport the new battery packs to the designated location with a forklift and manually push the battery packs into the cabinet. Secure the battery pack with M8 screws.

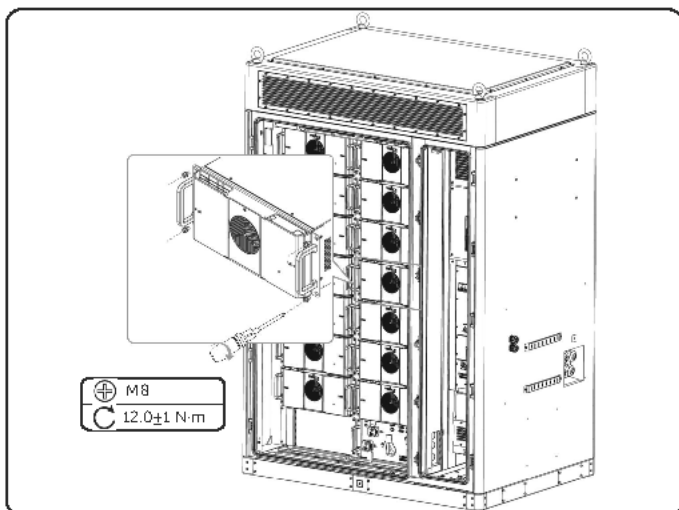

Figure 6-6 Installing the battery pack

Step 6: Install the copper bars and cables.

1. Remove the terminal cover. Install the negative copper bars, tightening M8 nut with a torque wrench (torque: 12.0 ± 1 N·m). Reinstall the terminal cover.
2. Install the positive copper bar in the same way.

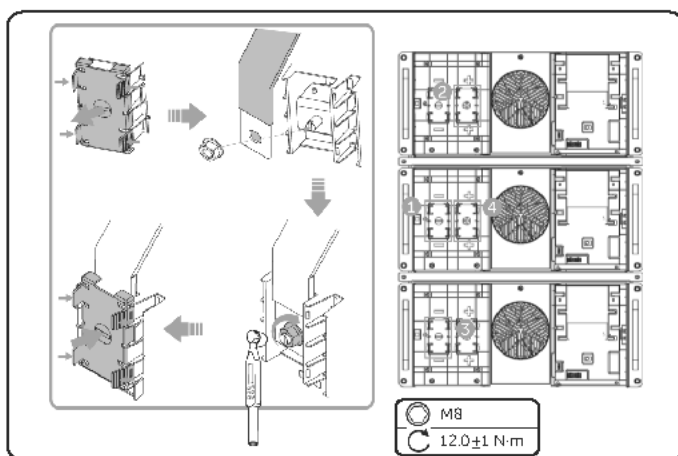

Figure 6-7 Installing the copper bars

3. Connect the fan power cables and communication cables of the battery pack.

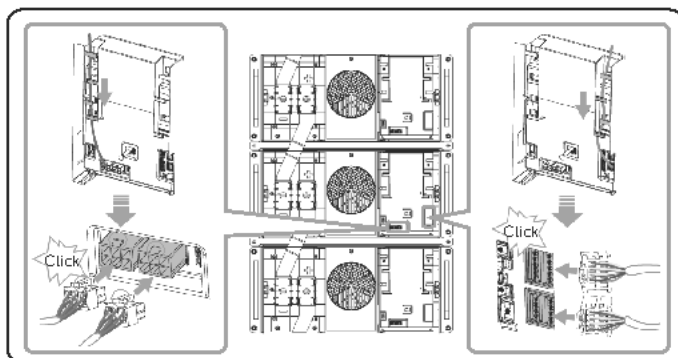

Figure 6-8 Removing the cables

Step 7: Close the covers on both sides of the battery packs.

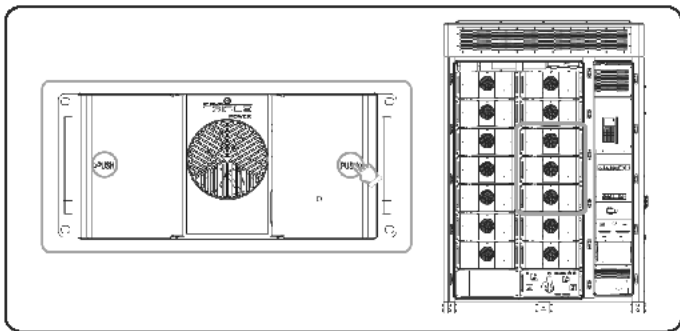

Figure 6-9 Closing battery pack covers

Step 8: Long press the button of the high-voltage box for 10 seconds for address assignment.

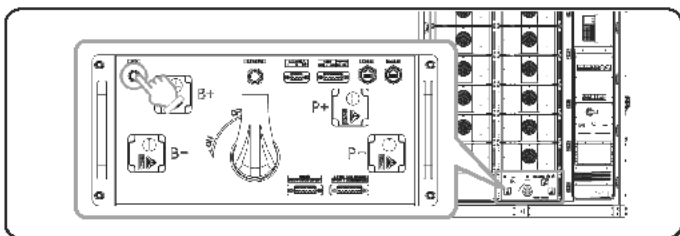

Figure 6-10 Address assignment

Checking after replacement

Step 1: Power on the system. For details, refer to "2.4 Power On".

Step 2: Check whether the functions are restored.

No.	Check Item	Criteria
1	Alarm information	The alarm status is displayed as resolved and no new alarms are generated
2	Function	The communication and charging/discharging functions are normal.
3	Appearance	<ul style="list-style-type: none"> • There is no obvious damage to the appearance. • There is no obvious paint peeling or rust. • The screws are secured. • The fans rotate properly without abnormal sound. • The front panel vent is clean and free from blockage.

7 Replacement of Battery Pack Fan

Prerequisites

- Fault locating:
 - a. View alarm information via cabinet screen, EMS1000 webpage or SolaXCloud App.
 - b. Refer to the alarm handling suggestions in the alarm details.
 - c. Contact SolaX and order replacement parts.
- Tools: Cross screwdriver, ladder.

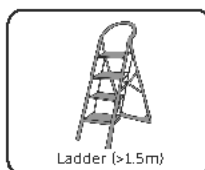
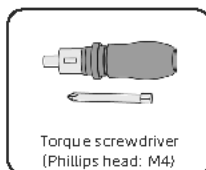

DANGER!

- Do not disassemble the battery violently. Otherwise, it may lead to battery pack short circuit, damage to the device (leakage, rupture), fire, or explosion.

WARNING!

- Before replacing the battery pack fan, ensure that the system is powered off. Otherwise, electric shocks may occur.
- After the system powers off, there will still be the remaining electricity and heat which may cause electric shocks and body burns. Please wear personal protective equipment (PPE) and begin servicing the system 15 minutes after power off.
- Only qualified person can perform the maintenance for the device.

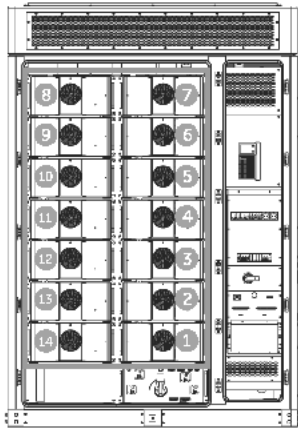

Figure 7-1 Position of the battery pack fans

Procedure

Step 1: Press to open the cover of the battery pack.

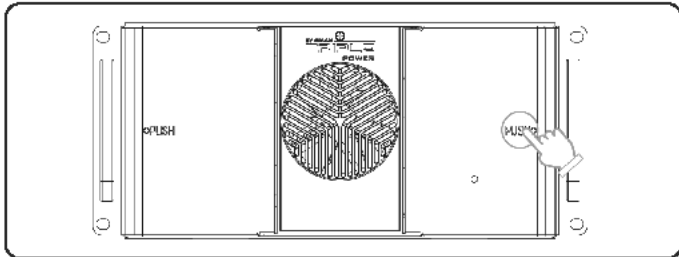

Figure 7-2 Opening the battery pack cover

Step 2: Remove the cable of the fan.

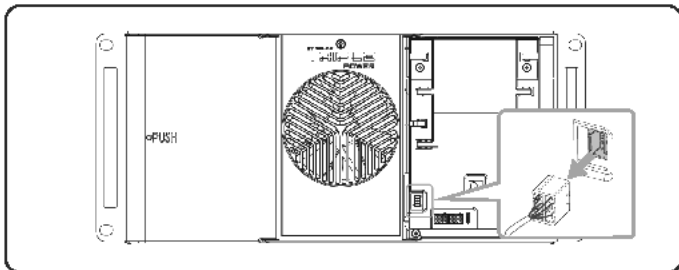

Figure 7-3 Removing the cable

Step 3: Unscrew the screw on the cover, remove the cover.

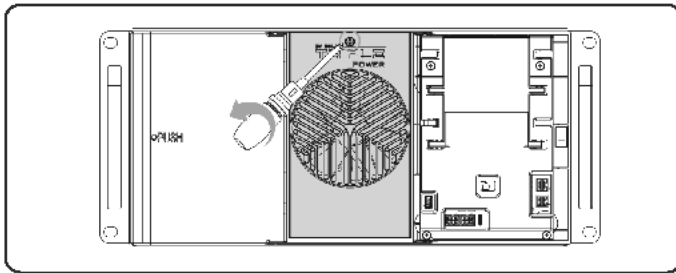

Figure 7-4 Removing the screw

Step 4: Unscrew the screws and remove the fan.

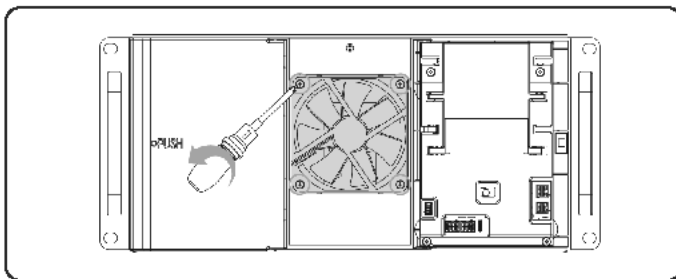

Figure 7-5 Removing the fan

Step 5: Install a new fan and connect the cables.

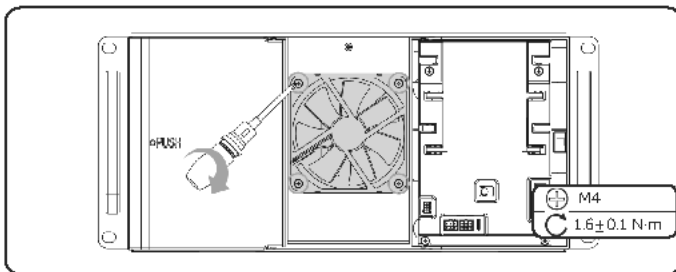

Figure 7-6 Installing a new fan

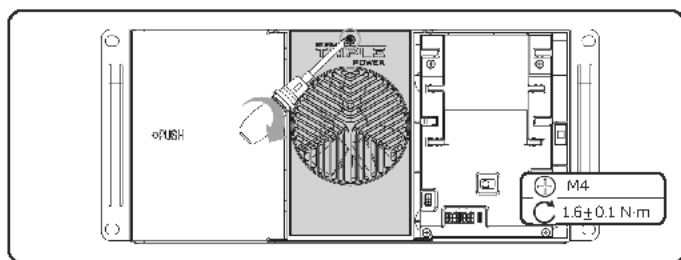

Figure 7-7 Installing the cover

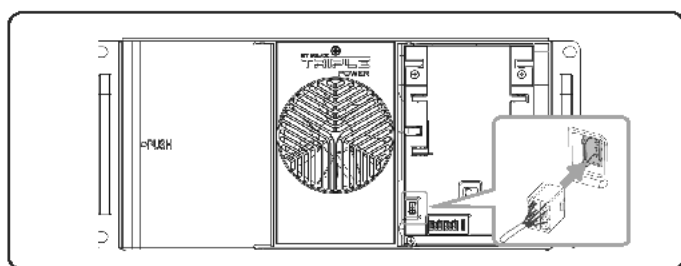

Figure 7-8 Connecting the cable

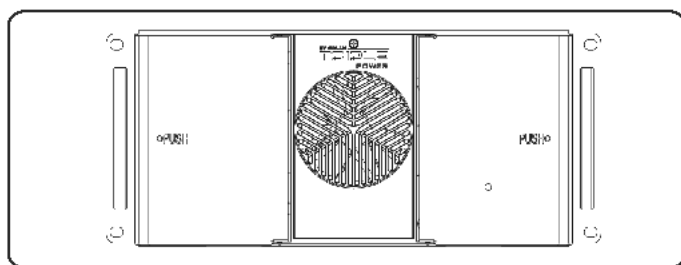

Figure 7-9 Closing the cover

Checking after replacement

For details of checking procedure after replacement, please refer to "30 Checking after Replacement".

8 Replacement of BMU

Prerequisites

- Fault locating:
 - a. View alarm information via cabinet screen, EMS1000 webpage or SolaXCloud App.
 - b. Refer to the alarm handling suggestions in the alarm details.
 - c. Contact SolaX and order replacement parts.
- Tools: Cross screwdriver, ladder.

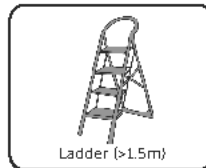
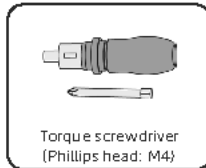

DANGER!

- Do not disassemble the battery violently. Otherwise, it may lead to battery pack short circuit, damage to the device (leakage, rupture), fire, or explosion.

WARNING!

- Before replacing the BMU, ensure that the system is powered off. Otherwise, electric shocks may occur.
- After the system powers off, there will still be the remaining electricity and heat which may cause electric shocks and body burns. Please wear personal protective equipment (PPE) and begin servicing the system 15 minutes after power off.
- Only qualified person can perform the maintenance for the device.

NOTICE!

- The replaced devices should be sent back to the local SolaX warehouse.

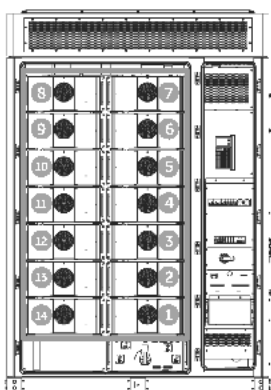

Figure 8-1 Position of the BMUs

Procedure

Step 1: Press to open the cover of the battery pack.

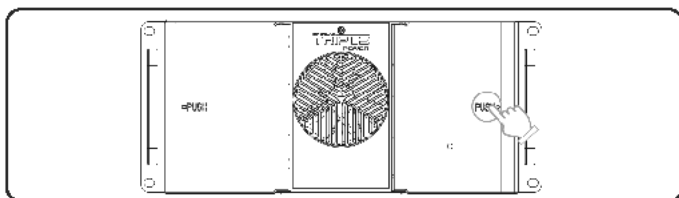

Figure 8-2 Opening the battery pack cover

Step 2: Remove the cables of the battery pack.

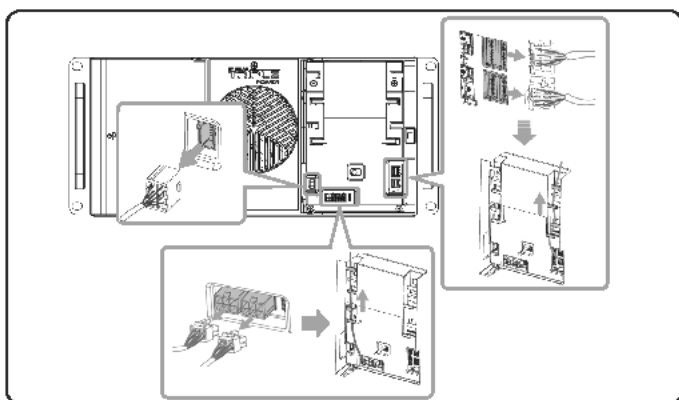

Figure 8-3 Removing the cables

Step 3: Remove the PCBA cover.

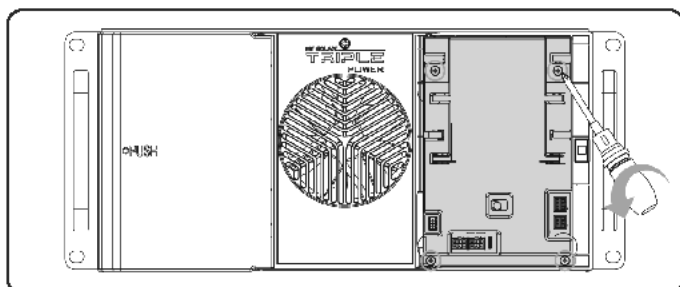

Figure 8-4 Removing the PCBA cover

Step 4: Removing the cables of the BMU.

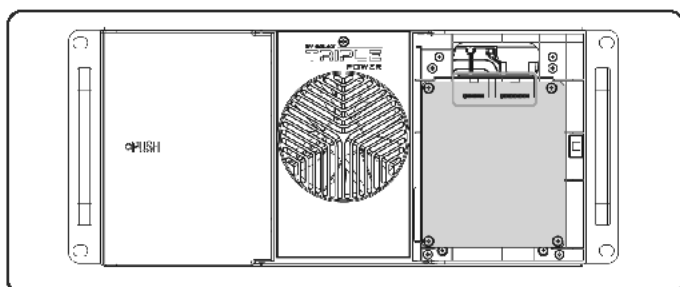

Figure 8-5 Removing the cables of the BMU

Step 5: Remove the BMU.

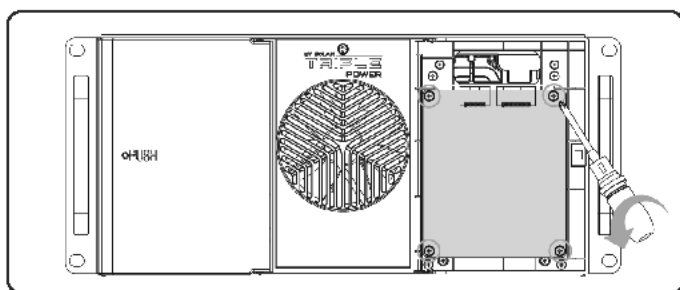

Figure 8-6 Removing the BMU

Step 6: Install a new BMU.

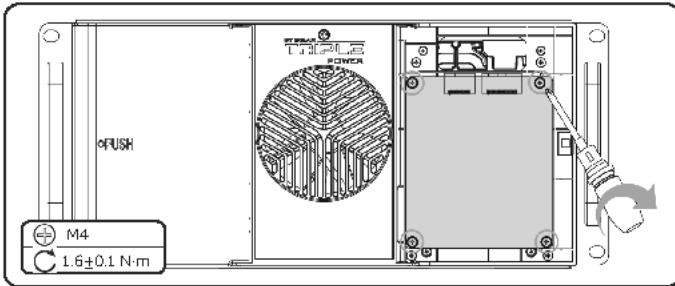

Figure 8-7 Installing a new BMU

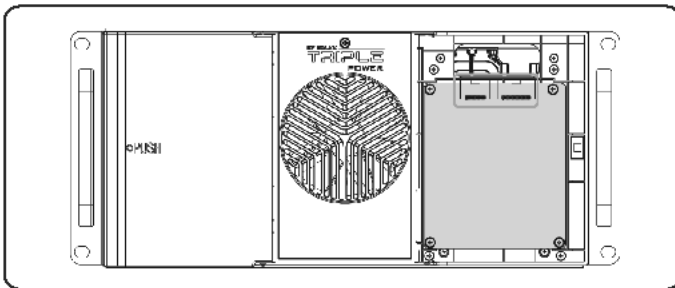

Figure 8-8 Connecting the cables of the BMU

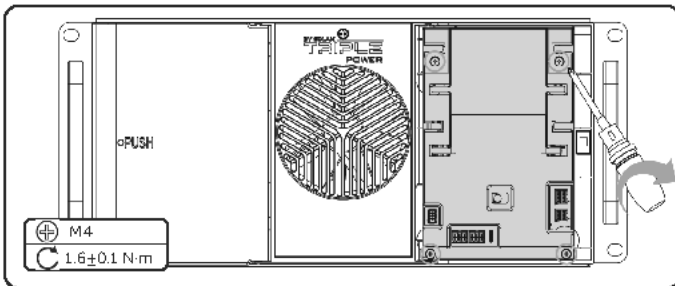

Figure 8-9 Installing the PCBA cover

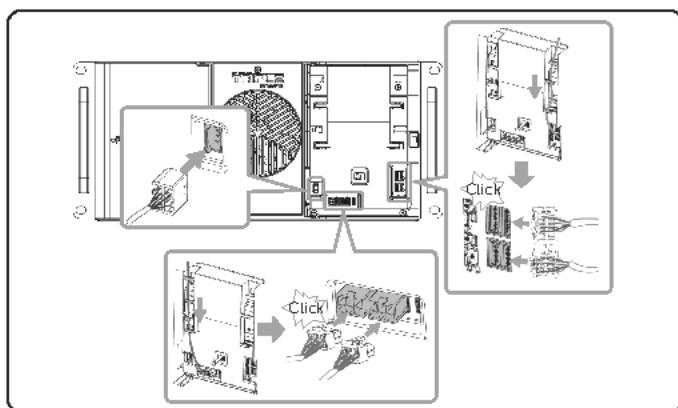

Figure 8-10 Connecting the cables of battery pack

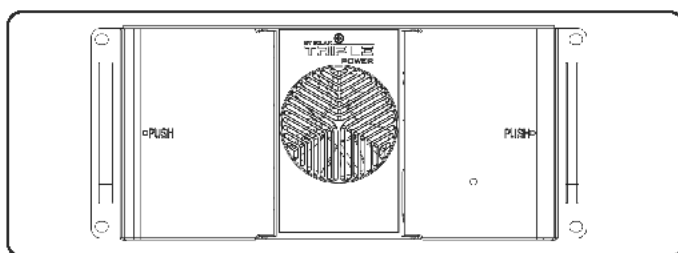

Figure 8-11 Closing the cover

Checking after replacement

- Step 1:** Power on the system. For details, refer to "2.4 Power On".
- Step 2:** Check whether the indicator on the battery pack front panel is flashing green light and check whether the battery pack communication is normal via EMS1000 webpage or SolaXCloud App.

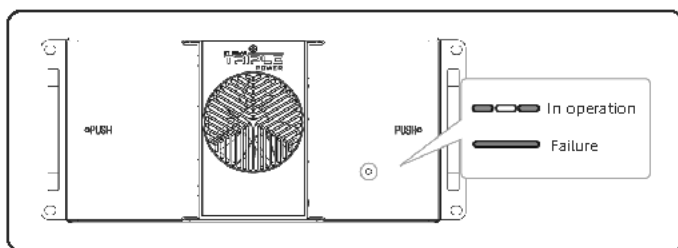
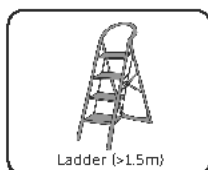
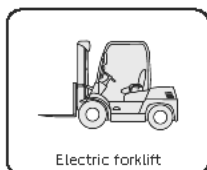
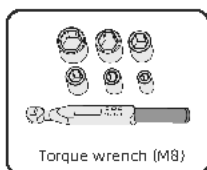
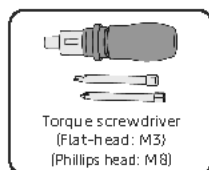

Figure 8-12 Battery pack indicator

9 Replacement of High-voltage Box

Prerequisites

- Fault locating:
 - a. View alarm information via cabinet screen, EMS1000 webpage or SolaXCloud App.
 - b. Refer to the alarm handling suggestions in the alarm details.
 - c. Contact SolaX and order replacement parts.
- Tools: Cross screwdriver, torque wrench, electric forklift, ladder.



WARNING!

- Before replacing the high-voltage box, ensure that the system is powered off. Otherwise, electric shocks may occur.
- After the system powers off, there will still be the remaining electricity and heat which may cause electric shocks and body burns. Please wear personal protective equipment (PPE) and begin servicing the system 15 minutes after power off.
- Only qualified person can perform the maintenance for the device.

NOTICE!

- The replaced devices should be sent back to the local SolaX warehouse.

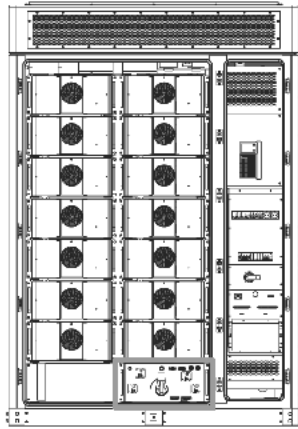

Figure 9-1 Position of the high-voltage box

Procedure

Step 1: Press to open the left covers of the battery packs.

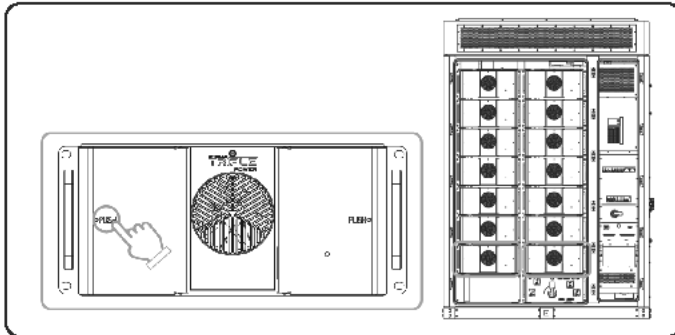

Figure 9-2 Opening the battery pack cover

Step 2: Remove the copper bar and cables.

1. Remove the negative terminal cover. Unscrew the M8 nut and remove the negative power cable, reinstall the negative terminal cover.

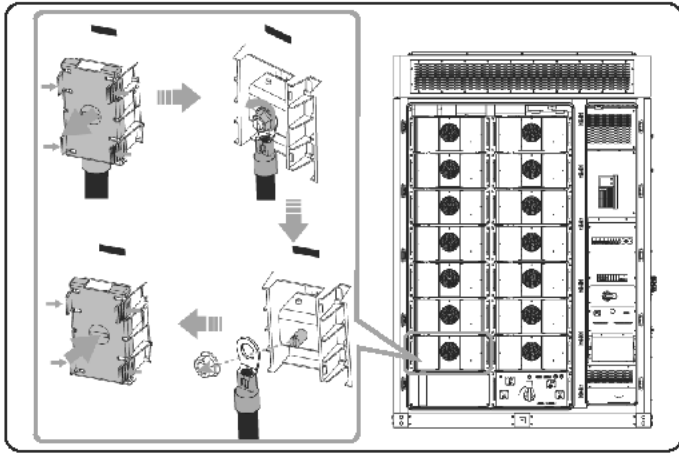

Figure 9-3 Removing the negative power cable

! WARNING!

- After removing the copper bars, it is necessary to install the covers back, otherwise electric shock may occur.

2. Remove the copper bar and cables of the positive terminal of circled battery pack and the B-, B+, P- and P+ terminals of the high-voltage box in the same way.

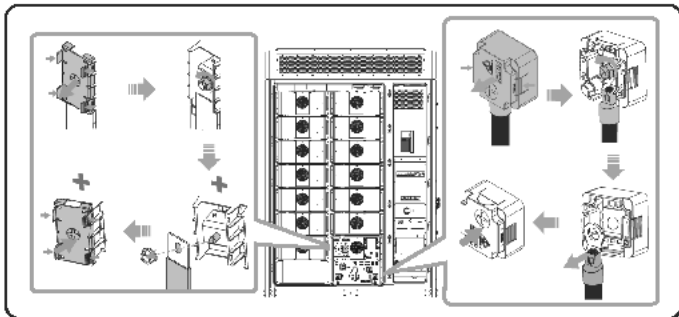

Figure 9-4 Removing the copper bars and cables

- Unplug the cables of the high-voltage box.

NOTICE!

- The following uses PCS communication cable and fan power cable as examples. Please remove all cables of the high-voltage box.

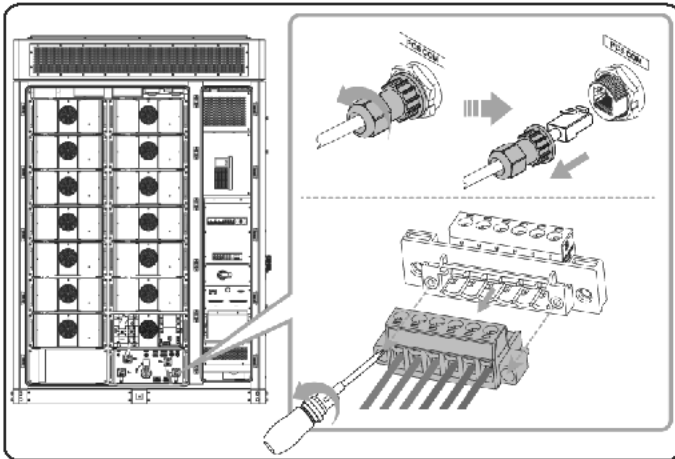

Figure 9-5 Removing cables of high-voltage box

- Step 3:** Unscrew the M8 screws on the high-voltage box.

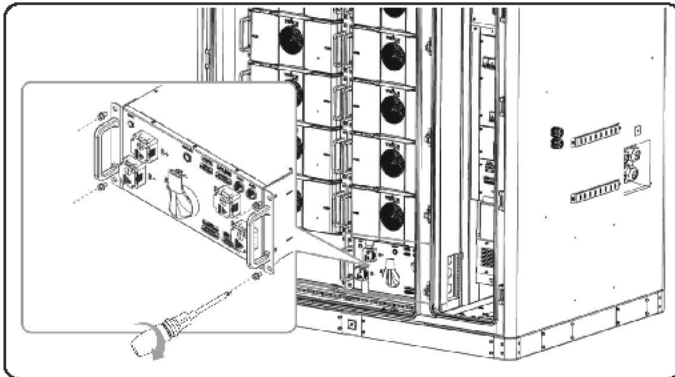

Figure 9-6 Removing screws on high-voltage box

- Step 4:** Draw the high-voltage box onto a forklift and transport it with the forklift.

Step 5: Transport the new high-voltage box to the designated location with a forklift and manually push the high-voltage box into the cabinet. Secure the high-voltage box with M8 screws.

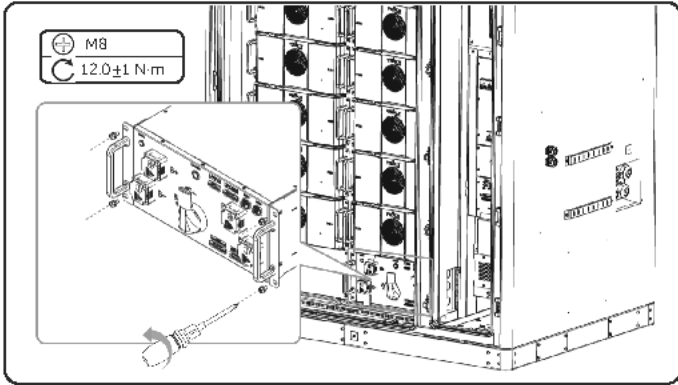

Figure 9-7 Installing the high-voltage box

Step 6: Install the copper bar and connect the cables.

1. Remove the negative terminal cover and unscrew the M8 nut. Connect the negative power cable and secure with M8 nut, reinstall the negative terminal cover.

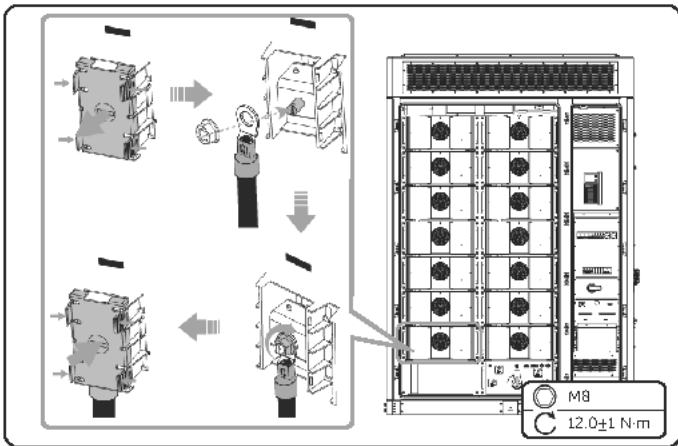

Figure 9-8 Connecting the negative power cable

- Connecting the copper bar and cables of the positive terminal of circled battery pack and the B-, B+, P- and P+ terminals of the high-voltage box in the same way.

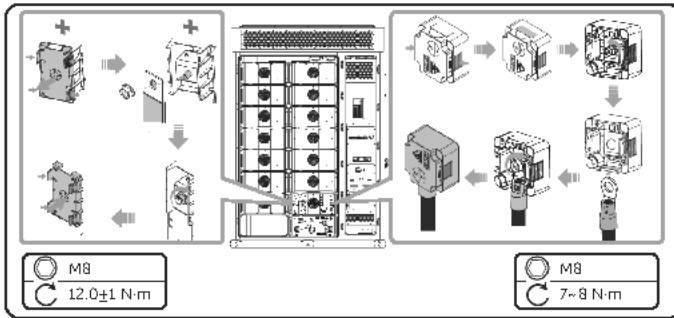

Figure 9-9 Connecting the copper bars and cables

- Connecting the cables of the high-voltage box.

NOTICE!

- The following uses PCS communication cable and fan power cable as examples. Please connect all cables of the high-voltage box.

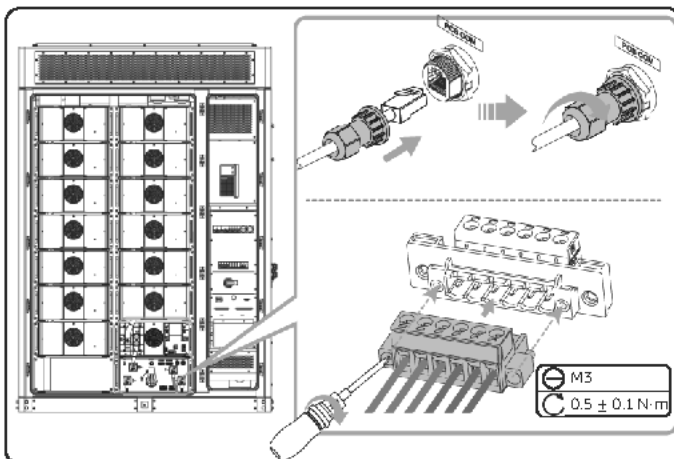

Figure 9-10 Connecting cables of high-voltage box

Step 7: Close the left covers of the battery packs.

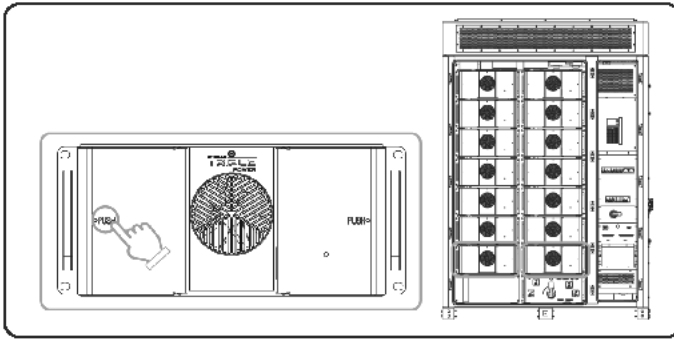

Figure 9-11 Closing the battery pack covers

Step 8: Long press the button of the high-voltage box for 10 seconds for address assignment.

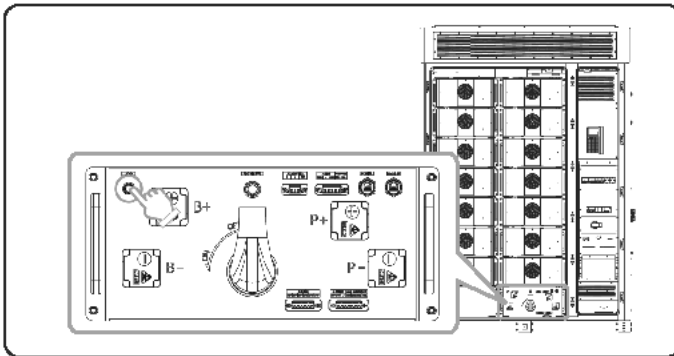

Figure 9-12 Address assignment

Checking after replacement

Step 1: Power on the system. For details, refer to "2.4 Power On".

Step 2: Log in to the screen, and then tap **Device > Device pairing**.

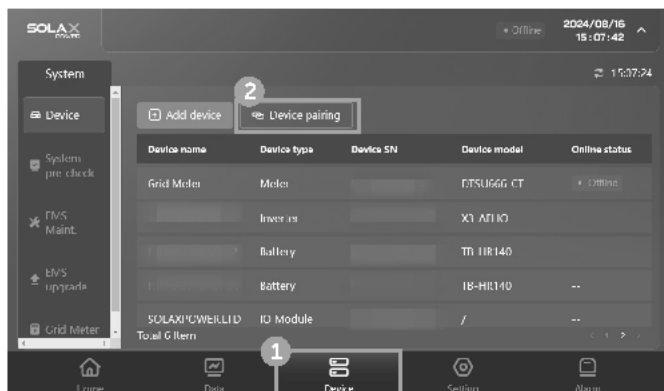

Figure 9-13 Device pairing

Step 3: Tap **Save and Pre-check** to save the pairing results.

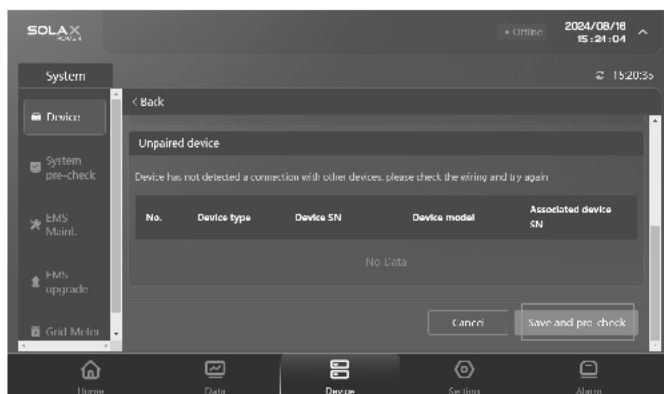

Figure 9-14 Save pairing

Step 4: Check whether the alarm status is displayed as resolved and no new alarms are generated via the cabinet screen.

10 Replacement of SBMU

Prerequisites

- Fault locating:
 - a. View alarm information via cabinet screen, EMS1000 webpage or SolaXCloud App.
 - b. Refer to the alarm handling suggestions in the alarm details.
 - c. Contact SolaX and order replacement parts.
- Tools: Cross screwdriver, torque wrench, electric forklift, ladder.

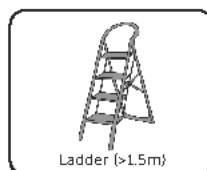
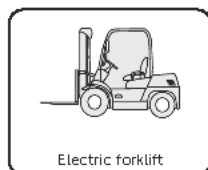
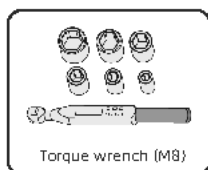
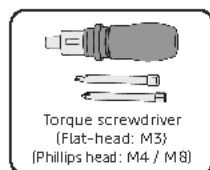

WARNING!

- Before replacing the SBMU, ensure that the system is powered off. Otherwise, electric shocks may occur.
- After the system powers off, there will still be the remaining electricity and heat which may cause electric shocks and body burns. Please wear personal protective equipment (PPE) and begin servicing the system 15 minutes after power off.
- Only qualified person can perform the maintenance for the device.

NOTICE!

- The replaced devices should be sent back to the local SolaX warehouse.

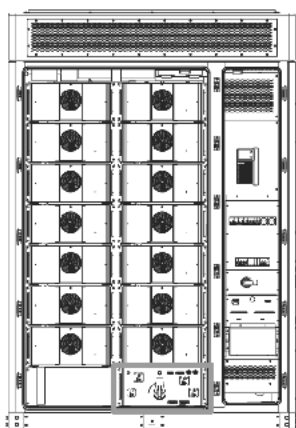

Figure 10-1 Position of the SBMU

Procedure

Step 1: Press to open the left covers of the battery packs.

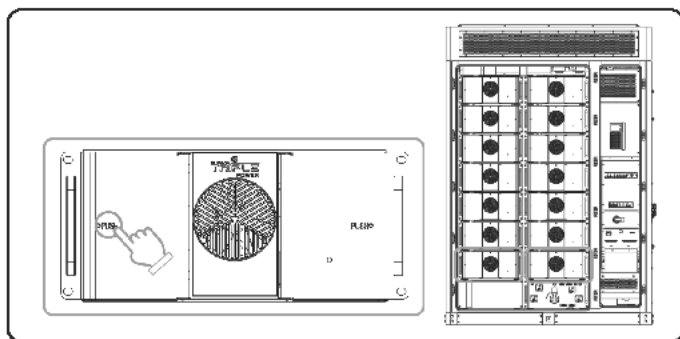

Figure 10-2 Opening the battery pack cover

Step 2: Remove the copper bar and cables.

1. Remove the negative terminal cover. Unscrew the M8 nut and remove the negative power cable, reinstall the negative terminal cover.

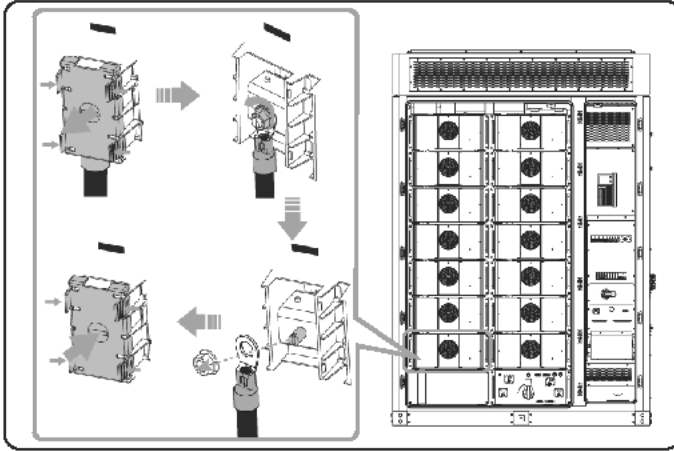

Figure 10-3 Removing the negative power cable

! WARNING!

- After removing the copper bars, it is necessary to install the covers back, otherwise electric shock may occur.

2. Remove the copper bar and cables of the positive terminal of circled battery pack and the B-, B+, P- and P+ terminals of the high-voltage box in the same way.

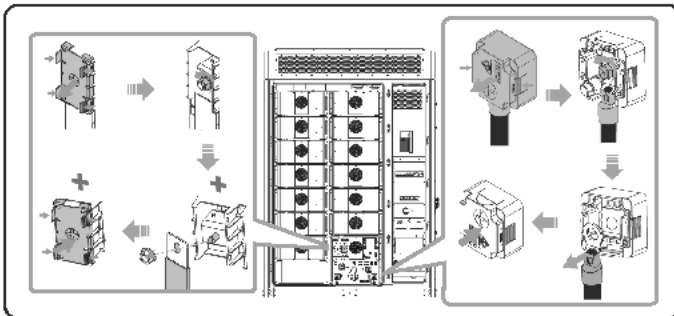

Figure 10-4 Removing the copper bars and cables

- Unplug the cables of the high-voltage box.

NOTICE!

- The following uses PCS communication cable and fan power cable as examples. Please connect all cables of the high-voltage box.

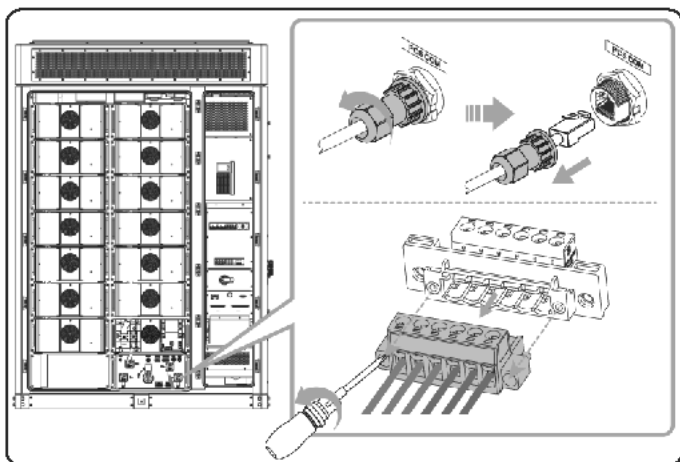

Figure 10-5 Removing cables of high-voltage box

- Step 3:** Unscrew the M8 screws on the high-voltage box.

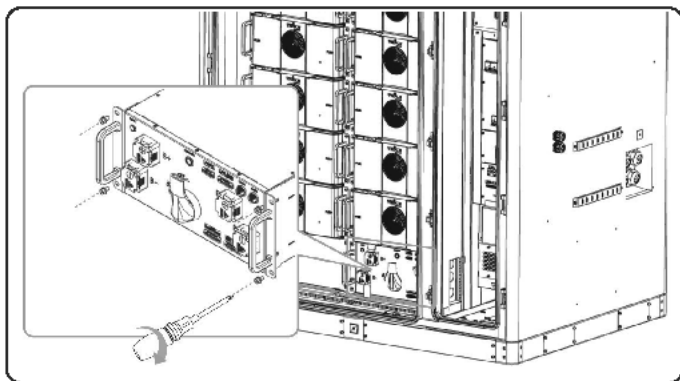

Figure 10-6 Removing screws on high-voltage box

- Step 4:** Draw the high-voltage box onto a forklift and transport it with the forklift.

Step 5: Unscrew the M4 screws and remove the top cover of the high-voltage box.

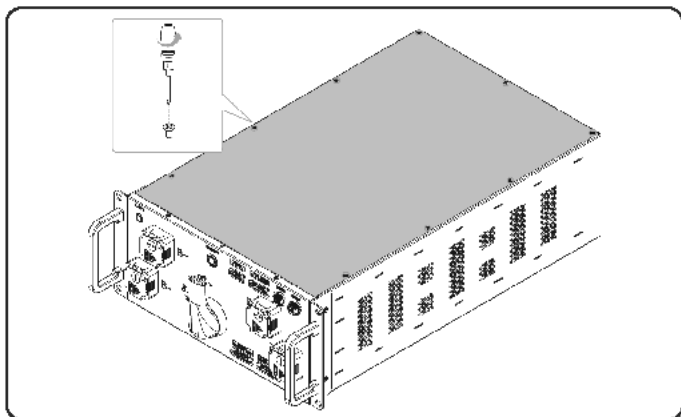

Figure 10-7 Removing the top cover

Step 6: Remove the cables of the SBMU. Unscrew the M4 screws and remove the SBMU.

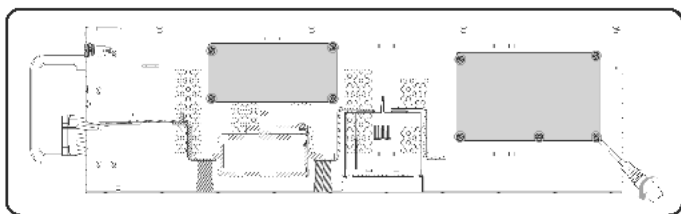

Figure 10-8 Removing the SBMU (right view)

Step 7: Connect the cables of the SBMU. Install new SBMU and secure with screws.

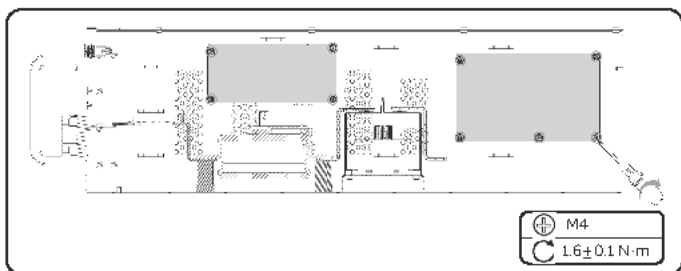

Figure 10-9 Installing the contactors (right view)

Step 8: Install the top cover of the high-voltage box and secure with screws.

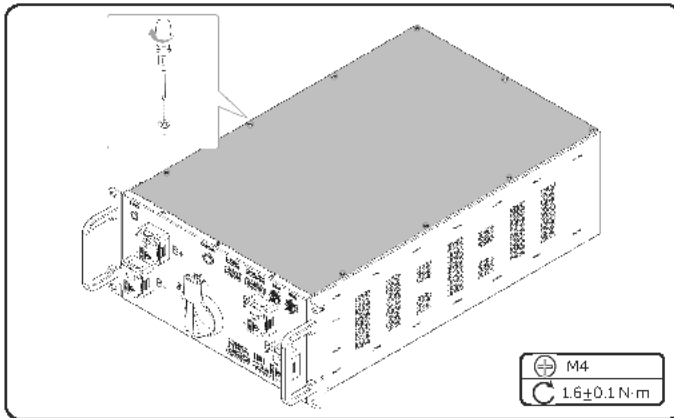

Figure 10-10 Installing the top cover

Step 9: Transport the new high-voltage box to the designated location with a forklift and manually push the high-voltage box into the cabinet. Secure the high-voltage box with M8 screws.

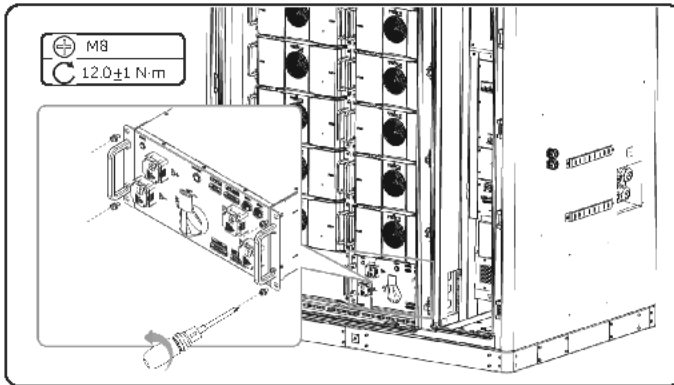

Figure 10-11 Installing the high-voltage box

Step 10: Install the copper bar and connect the cables.

1. Remove the negative terminal cover and unscrew the M8 nut. Connect the negative power cable and secure with M8 nut, reinstall the negative terminal cover.

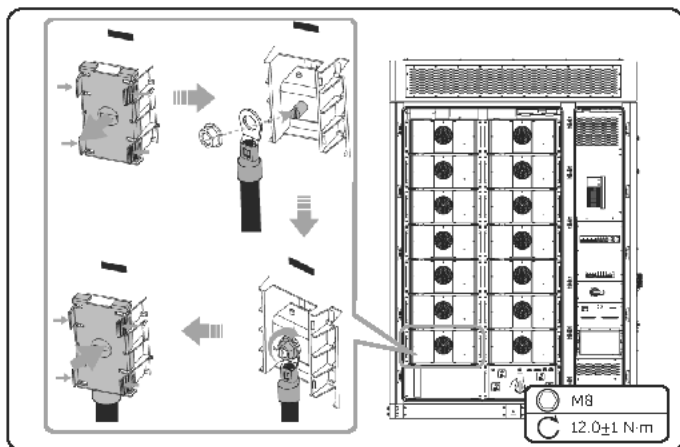

Figure 10-12 Connecting the negative power cable

2. Connecting the copper bar and cables of the positive terminal of circled battery pack and the B-, B+, P- and P+ terminals of the high-voltage box in the same way.

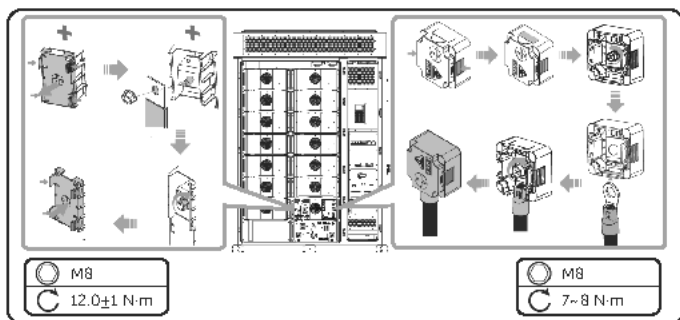

Figure 10-13 Connecting the copper bars and cables

3. Connecting the cables of the high-voltage box.

NOTICE!

- The following uses PCS communication cable and fan power cable as examples. Please connect all cables of the high-voltage box.

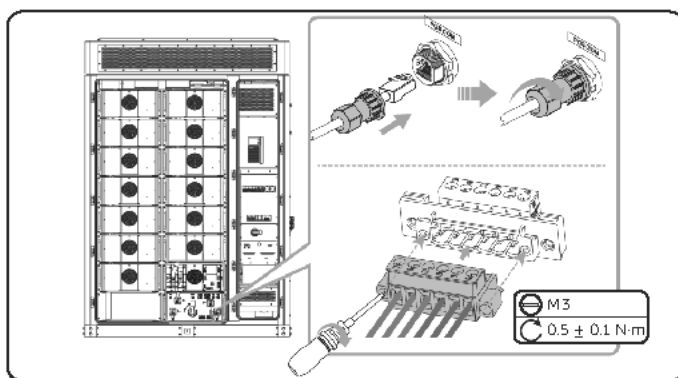

Figure 10-14 Connecting cables of high-voltage box

Step 11: Close the left covers of the battery packs.

Figure 10-15 Closing the battery pack covers

Step 12: Long press the button of the high-voltage box for 10 seconds for address assignment.

Figure 10-16 Address assignment

Checking after replacement

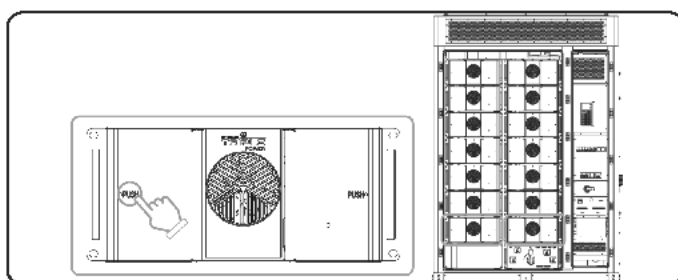
Step 1: Power on the system. For details, refer to "2.4 Power On".

Step 2: Log in to the screen, and then tap **Device > Device pairing**.

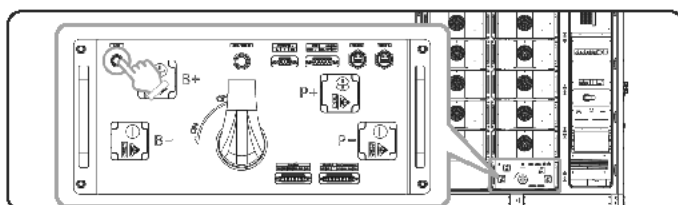

Figure 10-17 Device pairing

Step 3: Tap **Save and Pre-check** to save the pairing results.

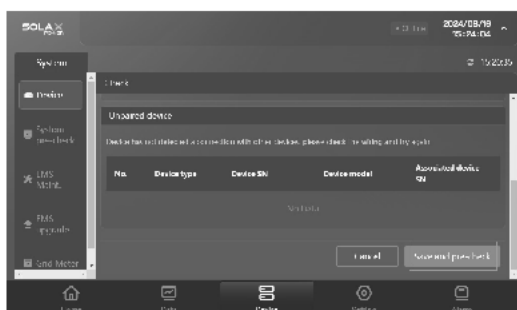

Figure 10-18 Save pairing

Step 4: Check whether the alarm status is displayed as resolved and no new alarms are generated via the cabinet screen.

Step 5: Check whether the indicator on the high voltage box front panel is flashing green light.

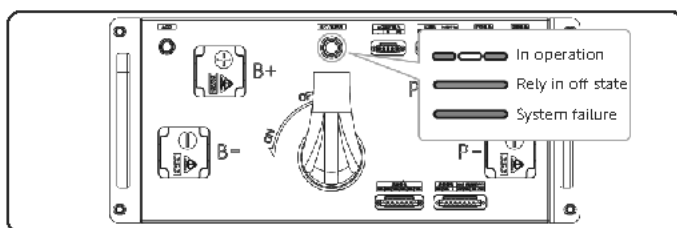
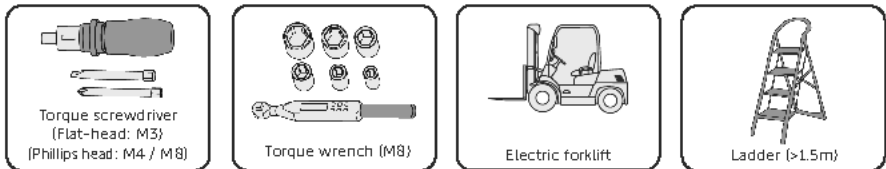

Figure 10-19 Checking the indicator

11 Replacement of High-voltage Box Fuse

Prerequisites

- Fault locating:
 - a. View alarm information via cabinet screen, EMS1000 webpage or SolaXCloud App.
 - b. Refer to the alarm handling suggestions in the alarm details.
 - c. Contact SolaX and order replacement parts.
- Tools: Cross screwdriver, torque wrench, electric forklift, multimeter, ladder.



⚠ WARNING!

- Before replacing the high-voltage box fuse, ensure that the system is powered off. Otherwise, electric shocks may occur.
- After the system powers off, there will still be the remaining electricity and heat which may cause electric shocks and body burns. Please wear personal protective equipment (PPE) and begin servicing the system 15 minutes after power off.
- Only qualified person can perform the maintenance for the device.

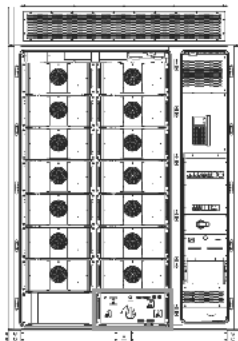

Figure 11-1 Position of the high-voltage box fuses

Procedure

Step 1: Press to open the left covers of the battery packs.

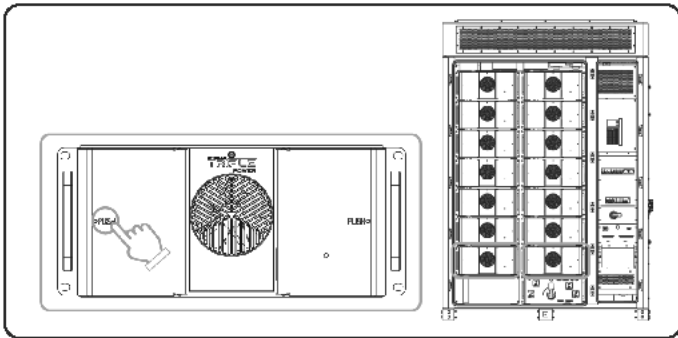

Figure 11-2 Opening the battery pack cover

Step 2: Remove the copper bar and cables.

1. Remove the negative terminal cover. Unscrew the M8 nut and remove the negative power cable, reinstall the negative terminal cover.

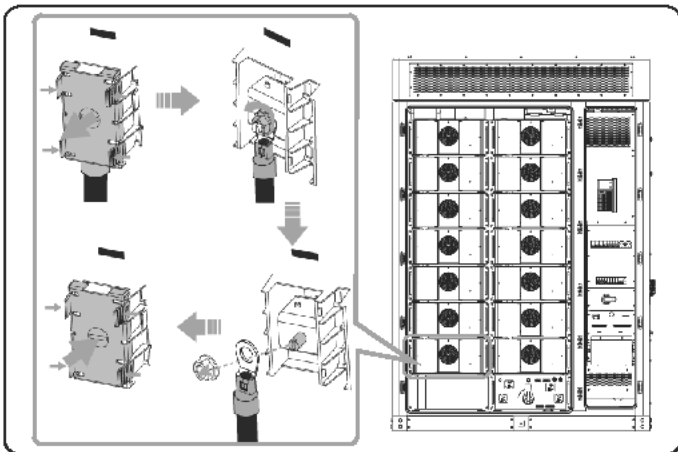

Figure 11-3 Removing the negative power cable

- Remove the copper bar and cables of the positive terminal of circled battery pack and the B-, B+, P-, and P+ terminals of the high-voltage box in the same way.

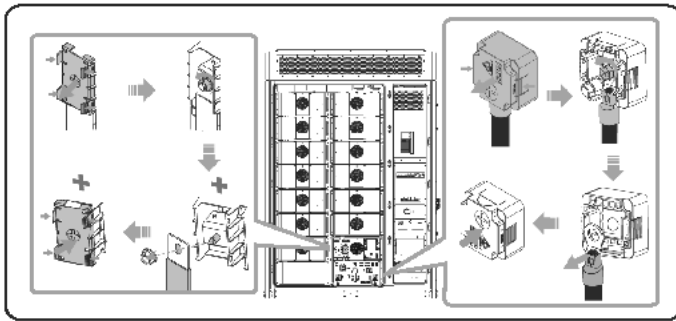

Figure 11-4 Removing the copper bars and cables

- Unplug the cables of the high-voltage box.

NOTICE!

- The following uses PCS communication cable and fan power cable as examples. Please remove all cables of the high-voltage box.

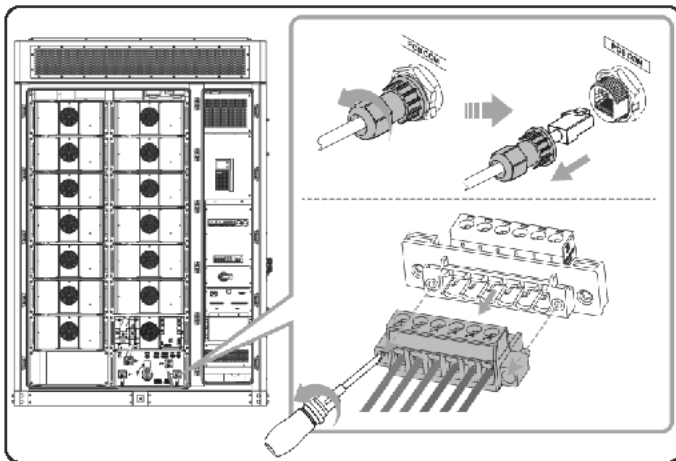

Figure 11-5 Removing cables of high-voltage box

Step 3: Unscrew the M8 screws on the high-voltage box.

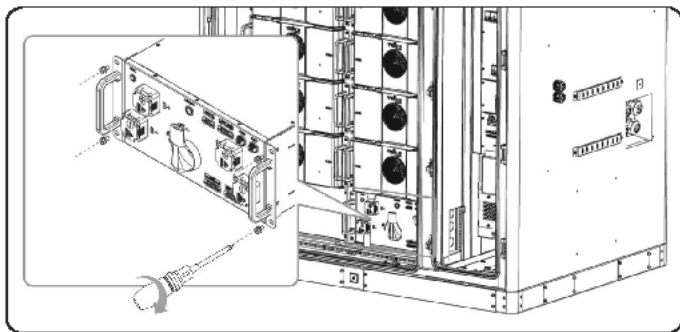

Figure 11-6 Removing screws on high-voltage box

Step 4: Draw the high-voltage box onto a forklift and transport it with the forklift.

Step 5: Unscrew the M4 screws and remove the top cover of the high-voltage box.

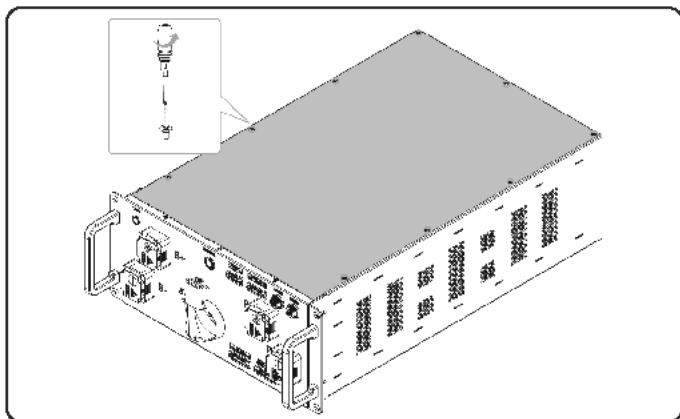

Figure 11-7 Removing the top cover

Step 6: Use a multimeter to measure the fuse ON-OFF status (ON for normal, OFF for abnormal).

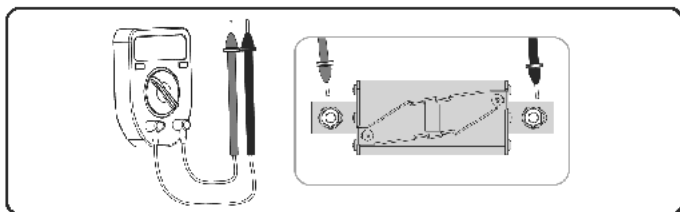

Figure 11-8 Measuring the fuse ON-OFF status

- Step 7:** Remove the cables of the fuse. Loosen the M8 nuts from the fuses and remove the fuses.

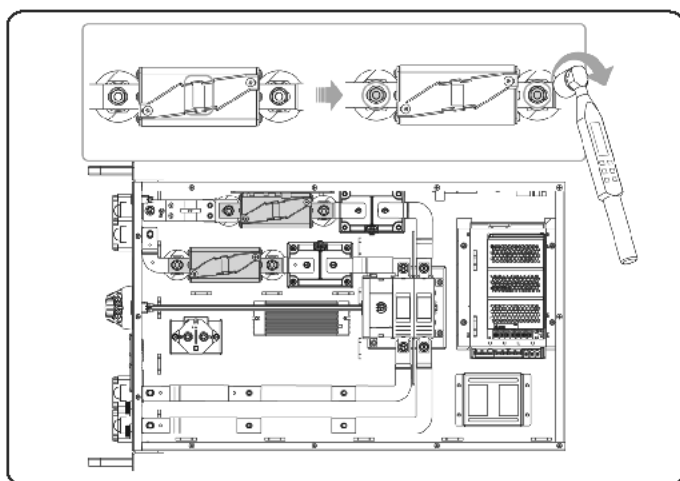

Figure 11-9 Removing the fuses (top view)

- Step 8:** Install new fuses and secure with nuts. Connect the cables of the fuse.

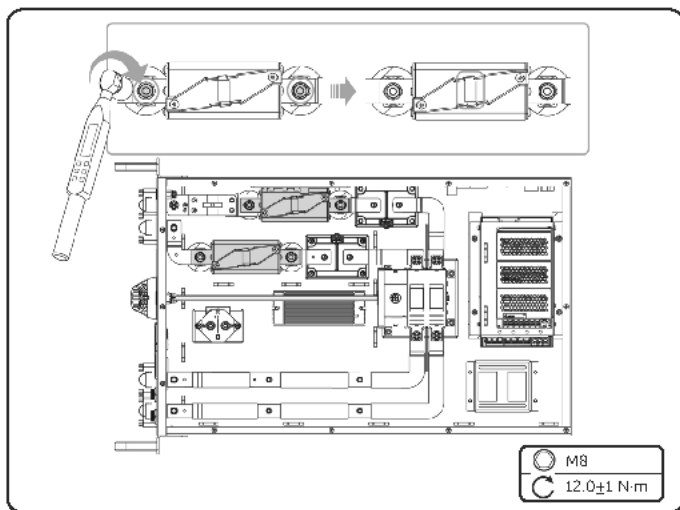

Figure 11-10 Installing the fuses (top view)

Step 9: Use a multimeter to measure the replaced fuse ON-OFF status (ON for normal, OFF for abnormal).

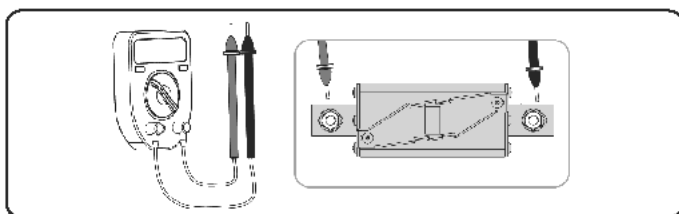

Figure 11-11 Measuring the fuse ON-OFF status

Step 10: Install the top cover of the high-voltage and secure with screws.

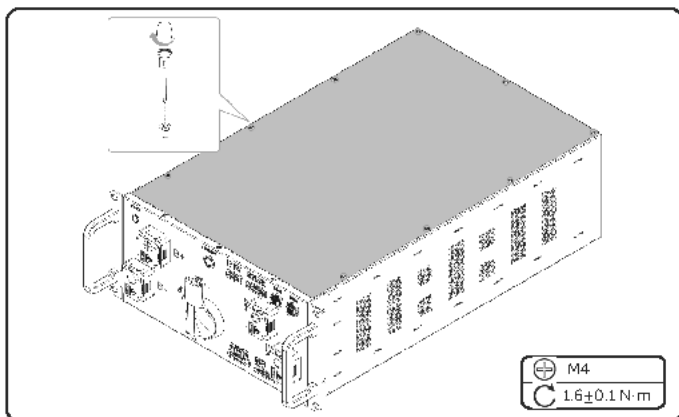

Figure 11-12 Installing the top cover

Step 11: Transport the new high-voltage box to the designated location with a forklift and manually push the high-voltage box into the cabinet. Secure the high-voltage box with M8 screws.

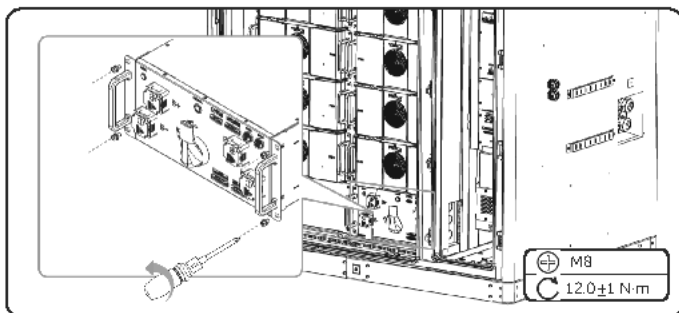

Figure 11-13 Installing the high-voltage box

Step 12: Install the copper bar and connect the cables.

1. Remove the negative terminal cover and unscrew the M8 nut. Connect the negative power cable and secure with M8 nut, reinstall the negative terminal cover.

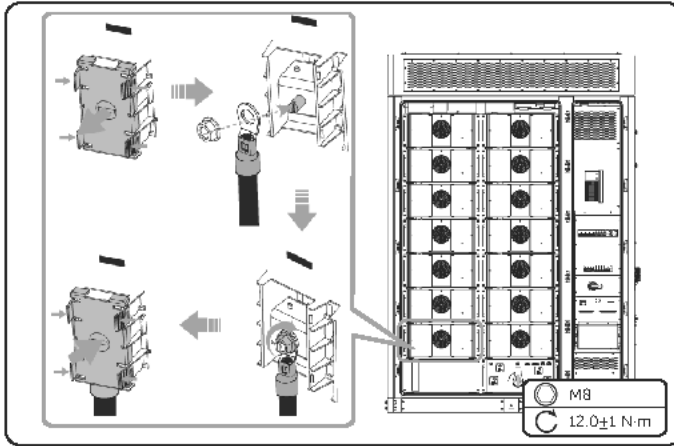

Figure 11-14 Connecting the negative power cable

2. Connecting the copper bar and cables of the positive terminal of circled battery pack and the B-, B+, P- and P+ terminals of the high-voltage box in the same way.

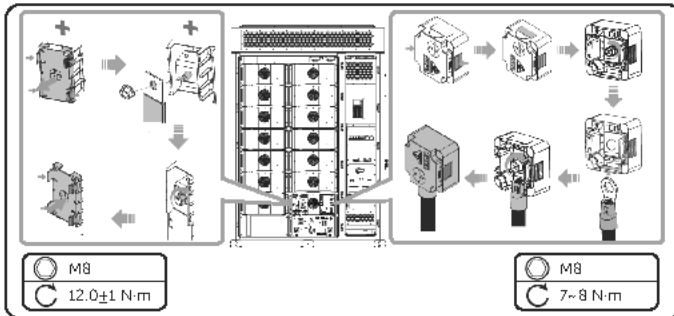

Figure 11-15 Connecting the copper bars and cables

3. Connecting the cables of the high-voltage box.

NOTICE!

- The following uses PCS communication cable and fan power cable as examples. Please connect all cables of the high-voltage box.

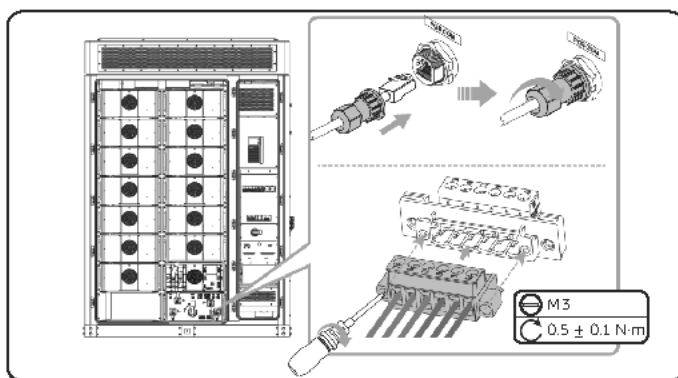

Figure 11-16 Connecting cables of high-voltage box

Step 13: Close the left covers of the battery packs.

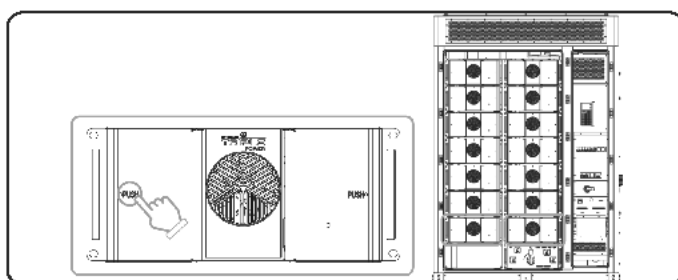

Figure 11-17 Closing the battery pack covers

Step 14: Long press the button of the high-voltage box for 10 seconds for address assignment.

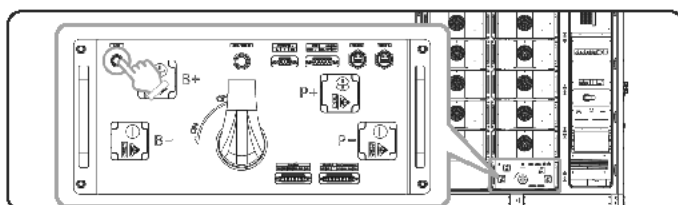
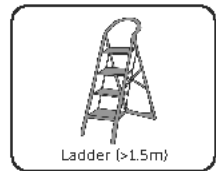
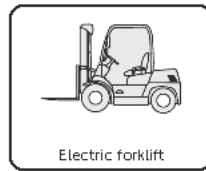
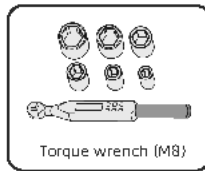
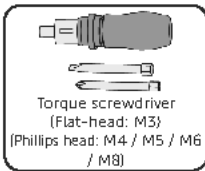

Figure 11-18 Address assignment

12 Replacement of High-voltage Box Contactor

Prerequisites

- Fault locating:
 - a. View alarm information via cabinet screen, EMS1000 webpage or SolaXCloud App.
 - b. Refer to the alarm handling suggestions in the alarm details.
 - c. Contact SolaX and order replacement parts.
- Tools: Cross screwdriver, torque wrench, electric forklift, multimeter, ladder.



WARNING!

- Before replacing the high-voltage box contactor, ensure that the system is powered off. Otherwise, electric shocks may occur.
- After the system powers off, there will still be the remaining electricity and heat which may cause electric shocks and body burns. Please wear personal protective equipment (PPE) and begin servicing the system 15 minutes after power off.
- Only qualified person can perform the maintenance for the device.

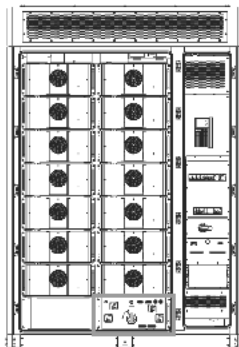

Figure 12-1 Position of the high-voltage box contactors

Procedure

Step 1: Press to open the left covers of the battery packs.

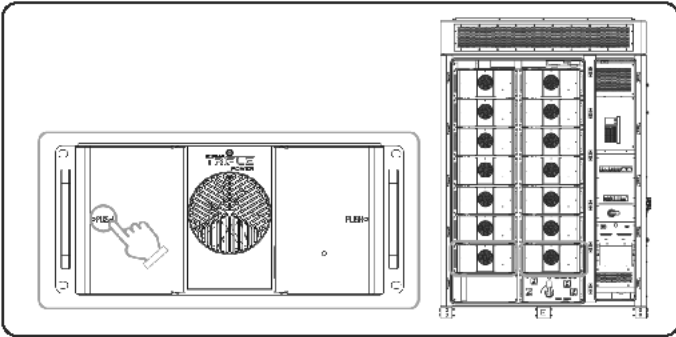

Figure 12-2 Opening the battery pack cover

Step 2: Remove the copper bar and cables.

1. Remove the negative terminal cover. Unscrew the M8 nut and remove the negative power cable, reinstall the negative terminal cover.

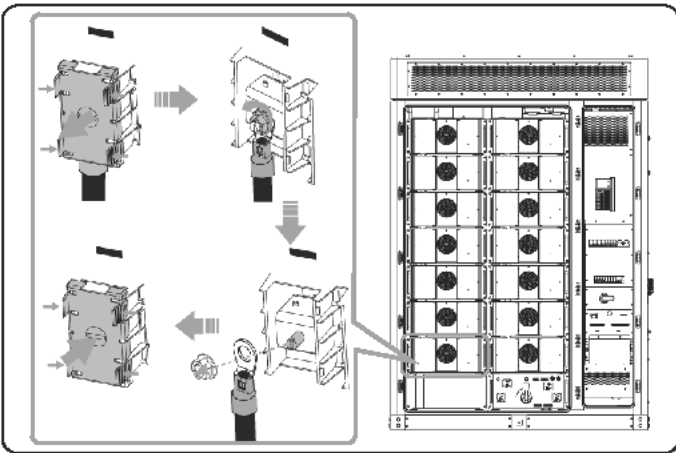

Figure 12-3 Removing the negative power cable



WARNING!

- After removing the copper bars, it is necessary to install the covers back, otherwise electric shock may occur.

- Remove the copper bar and cables of the positive terminal of circled battery pack and the B-, B+, P- and P+ terminals of the high-voltage box in the same way.

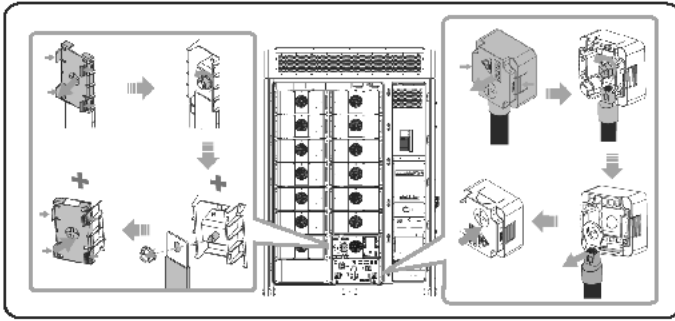

Figure 12-4 Removing the copper bars and cables

- Unplug the cables of the high-voltage box.

NOTICE!

- The following uses PCS communication cable and fan power cable as examples. Please remove all cables of the high-voltage box.

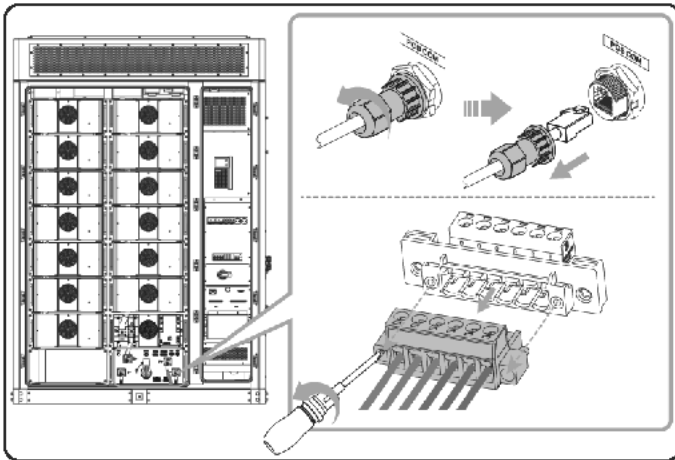

Figure 12-5 Removing cables of high-voltage box

Step 3: Unscrew the M8 screws on the high-voltage box.

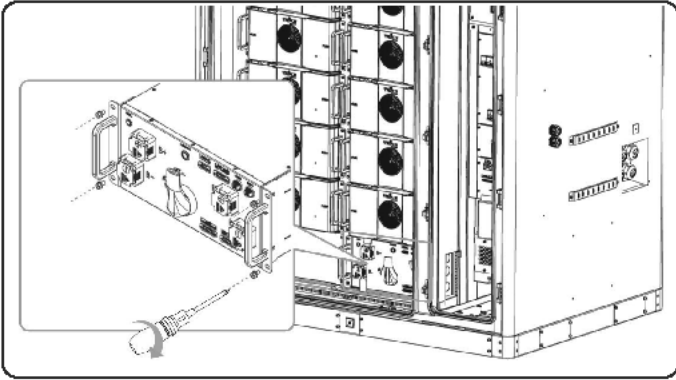

Figure 12-6 Removing screws on high-voltage box

Step 4: Draw the high-voltage box onto a forklift and transport it with the forklift.

Step 5: Unscrew the M4 screws and remove the top cover of the high-voltage box.

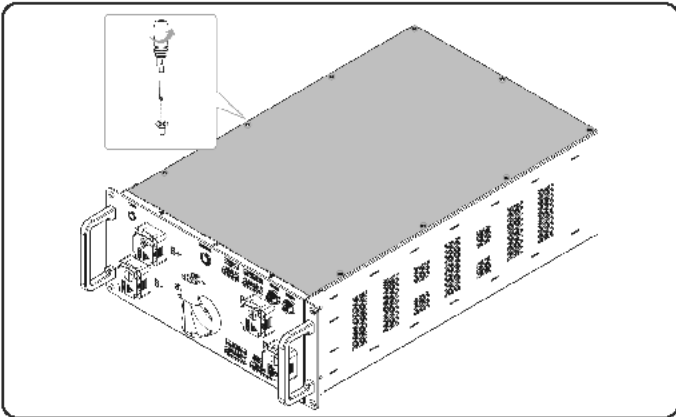

Figure 12-7 Removing the top cover

- Step 6:** Use a multimeter to measure the contactor ON-OFF status (ON for abnormal, OFF for normal).

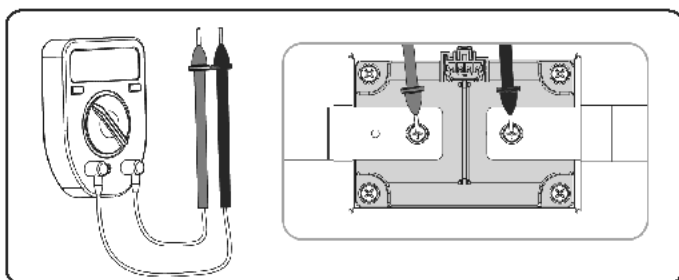

Figure 12-8 Measuring the contactor ON-OFF status

- Step 7:** Remove the cables of the fuse. Loosen the M8 nuts from the fuses and remove the fuses.

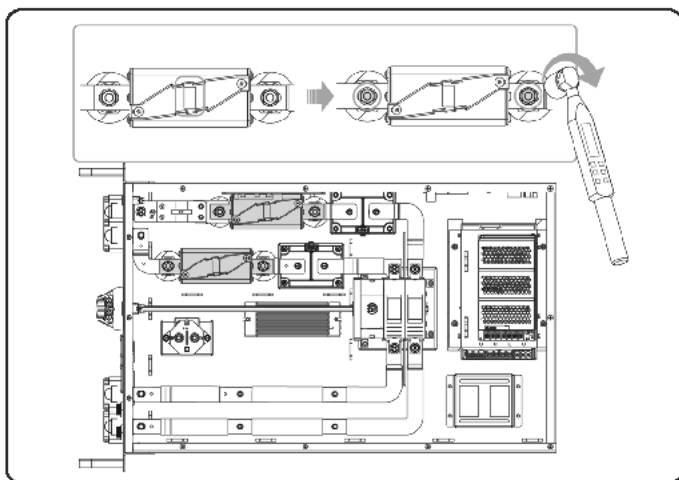

Figure 12-9 Removing the fuses (top view)

Step 8: Remove cables from the contactors. Unscrew the M5 screws and M8 nut of the copper bars on the contactors, remove the copper bar. Unscrew the M6 screws and remove the contactors.

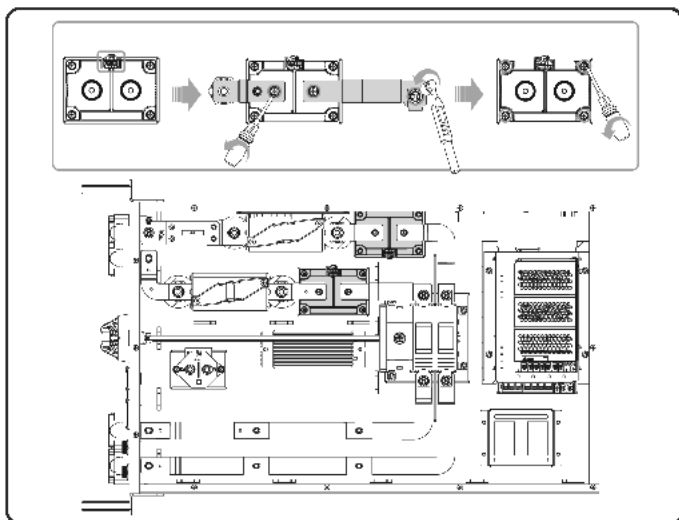

Figure 12-10 Removing the contactors (top view)

Step 9: Install new contactors, and secure with screws. Install the copper bar and connect the cable.

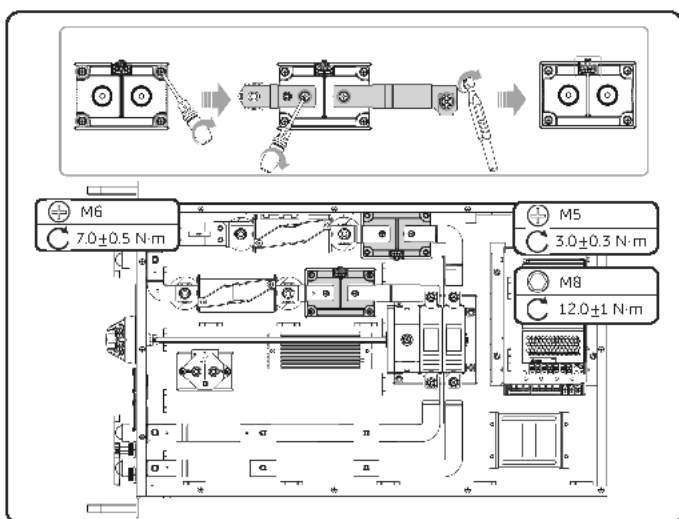

Figure 12-11 Installing the contactors (top view)

Step 10: Install fuses and secure with nuts. Connect the cables of the fuse.

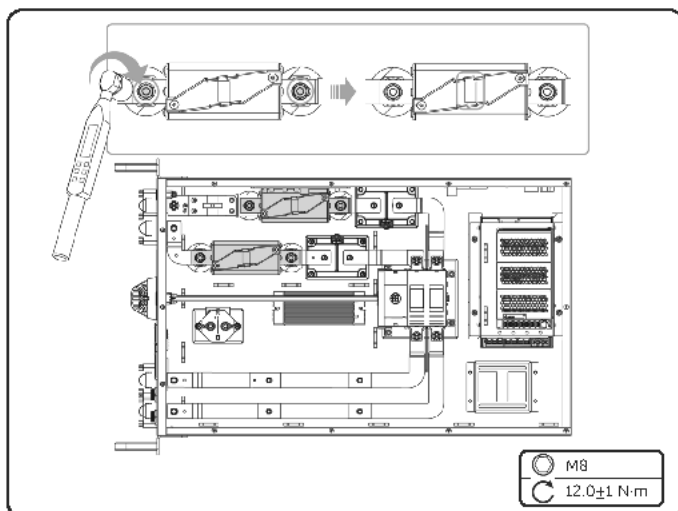

Figure 12-12 Installing the fuses (top view)

Step 11: Use a multimeter to measure the replaced contactor ON-OFF status (ON for abnormal, OFF for normal).

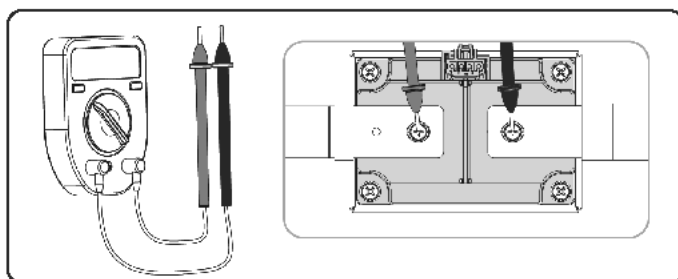

Figure 12-13 Measuring the contactor ON-OFF status

Step 12: Install the top cover of the high-voltage and secure with screws.

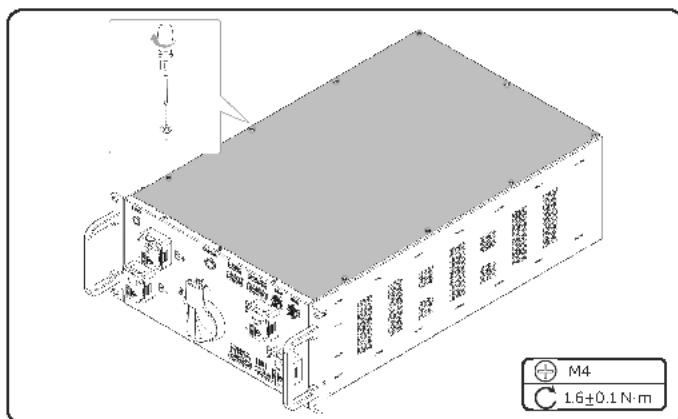

Figure 12-14 Installing the top cover

Step 13: Transport the new high-voltage box to the designated location with a forklift and manually push the high-voltage box into the cabinet. Secure the high-voltage box with M8 screws.

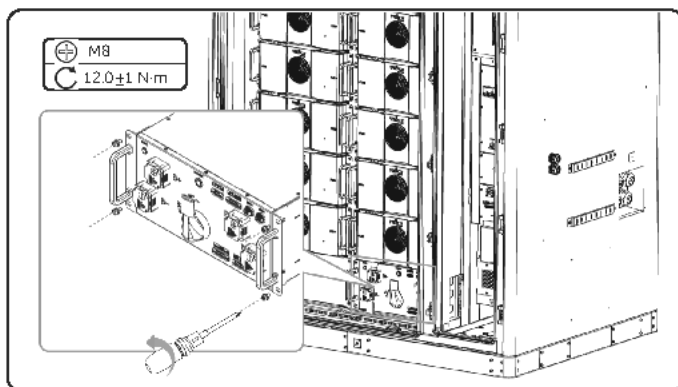

Figure 12-15 Installing the high-voltage box

Step 14: Install the copper bar and connect the cables.

1. Remove the negative terminal cover and unscrew the M8 nut. Connect the negative power cable and secure with M8 nut, reinstall the negative terminal cover.

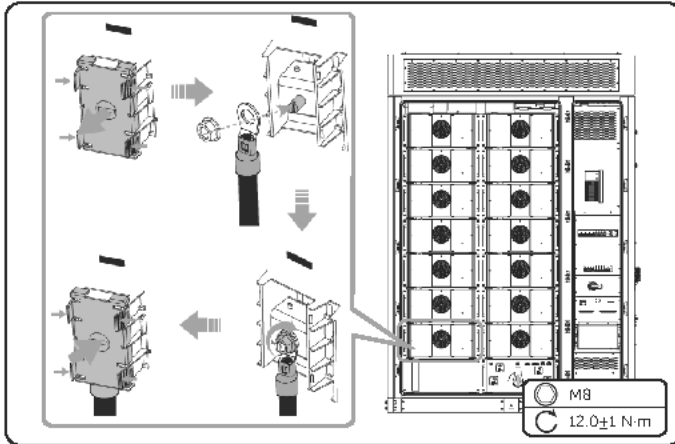

Figure 12-16 Connecting the negative power cable

2. Connecting the copper bar and cables of the positive terminal of circled battery pack and the B-, B+, P- and P+ terminals of the high-voltage box in the same way.

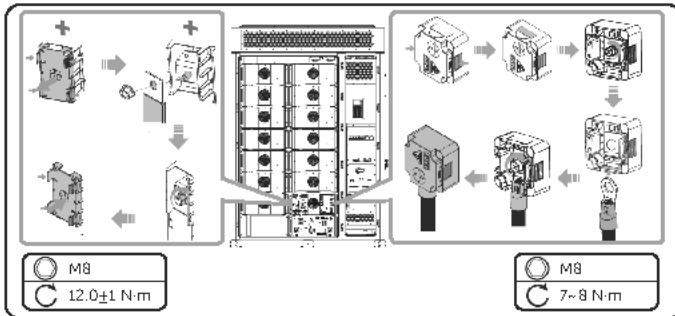

Figure 12-17 Connecting the copper bars and cables

3. Connecting the cables of the high-voltage box.

NOTICE!

- The following uses PCS communication cable and fan power cable as examples. Please connect all cables of the high-voltage box.

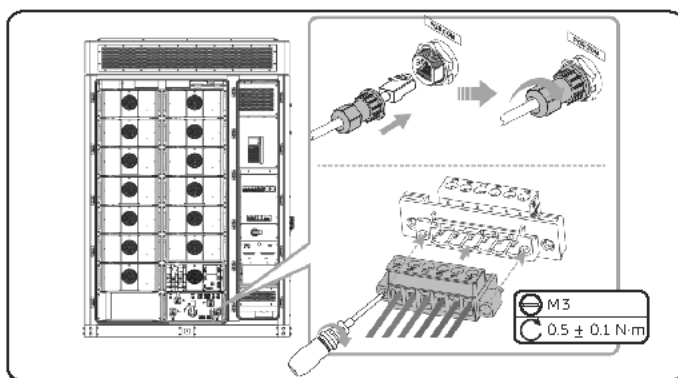

Figure 12-18 Connecting cables of high-voltage box

Step 15: Close the left covers of the battery packs.

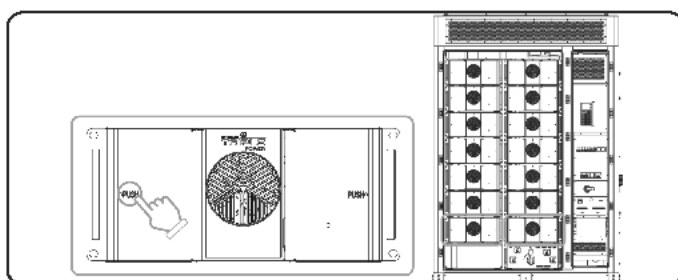

Figure 12-19 Closing the battery pack covers

Step 16: Long press the button of the high-voltage box for 10 seconds for address assignment.

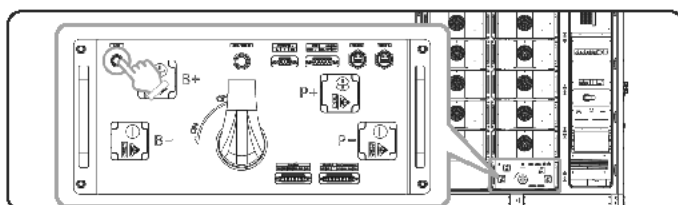
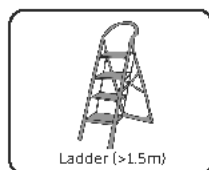
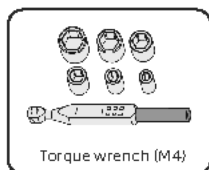
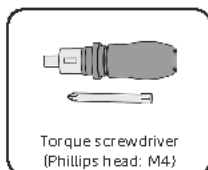

Figure 12-20 Address assignment

13 Replacement of EMS1000

Prerequisites

- Fault locating:
 - a. View alarm information via cabinet screen, EMS1000 webpage or SolaXCloud App.
 - b. Refer to the alarm handling suggestions in the alarm details.
 - c. Contact SolaX and order replacement parts.
- Tools: Cross screwdriver, torque wrench, ladder.



WARNING!

- Before replacing the EMS1000, ensure that the system is powered off. Otherwise, electric shocks may occur.
- After the system powers off, there will still be the remaining electricity and heat which may cause electric shocks and body burns. Please wear personal protective equipment (PPE) and begin servicing the system 15 minutes after power off.
- Only qualified person can perform the maintenance for the device.

NOTICE!

- The replaced devices should be sent back to the local SolaX warehouse.

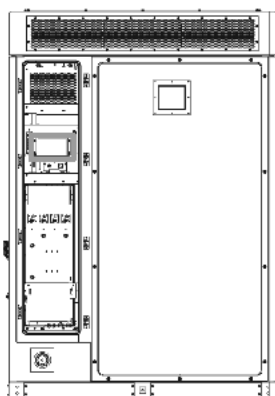

Figure 13-1 Position of the EMS1000 (rear view)

Procedure

Step 1: Use keys to open the rear door.

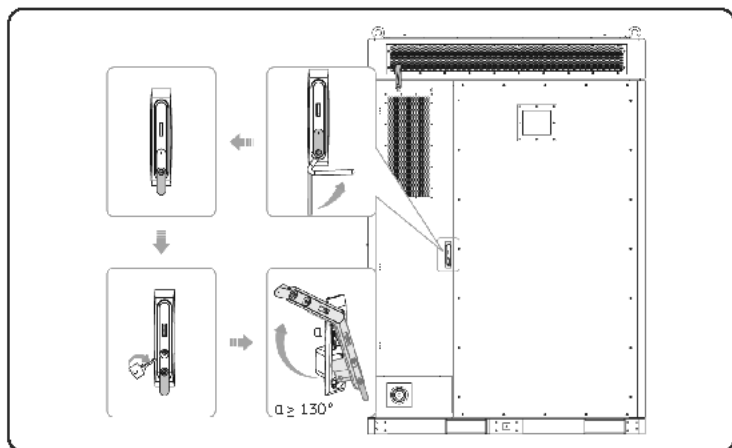

Figure 13-2 Opening rear door

NOTICE!

- Please keep the keys properly.

Step 2: Remove cables from EMS1000.

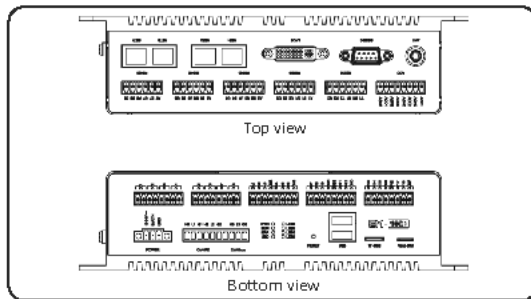

Figure 13-1 EMS1000 wiring area

Step 3: Remove the cables on the front of the sheet metal and on the switch.

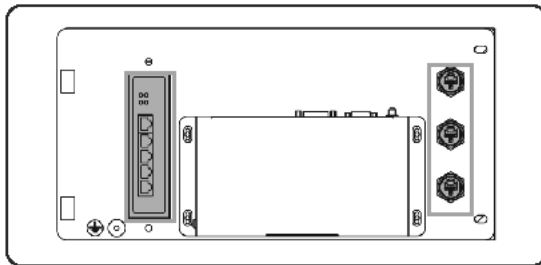

Figure 13-2 Sheet metal (front view)

Step 4: Unscrew the screws on the metal plate, remove the cables on the back of the metal plate, and then remove the EMS1000 and the metal plate together.

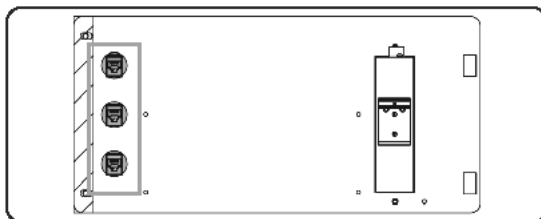

Figure 13-3 Sheet metal wiring area (rear view)

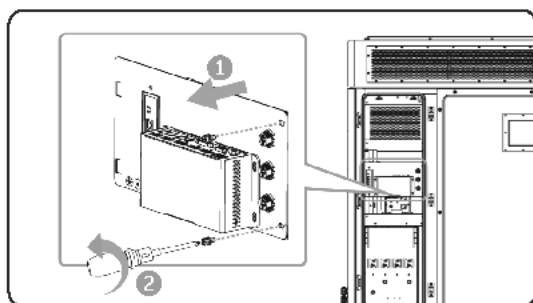

Figure 13-4 Removing the sheet metal

Step 5: Remove the EMS1000 from the sheet metal.

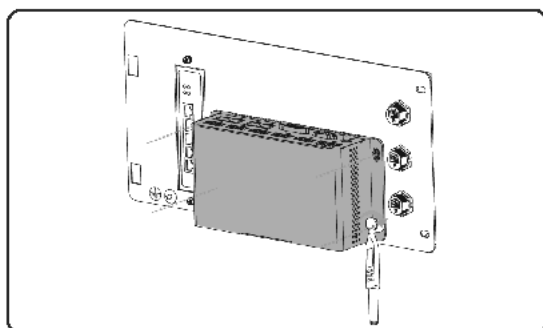

Figure 13-5 Removing the EMS1000

Step 6: Install a new EMS1000 to the sheet metal.

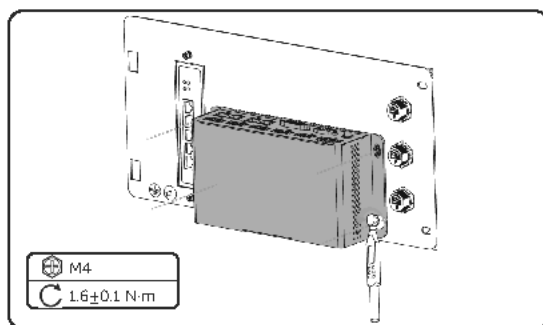

Figure 13-6 Installing a new EMS1000

- Step 7:** Connect the cables on the back of the sheet metal and install the sheet metal with EMS1000 to the cabinet.

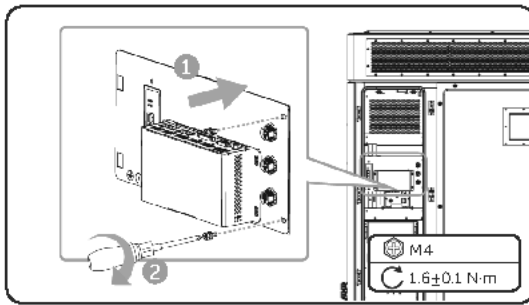

Figure 13-7 Installing the sheet metal

- Step 8:** Connect the cables of EMS1000, Switch and cables on front of the sheet metal according to silk screen and cable markings.
- Step 9:** Close the door after the device has been started.

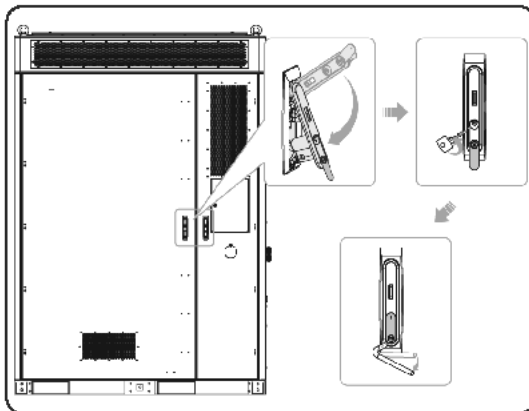

Figure 13-8 Closing the door

NOTICE!

- Please properly keep the key.

Checking after replacement

For details of checking procedure after replacement, please refer to "30 Checking after Replacement".

14 Replacement of Switch

Prerequisites

- Fault locating:
 - a. Remove the front panel.
 - b. The indicator of switch is off.
- Tools: Cross screwdriver, ladder.

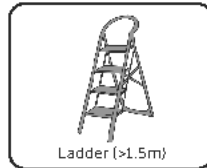
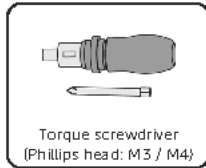

WARNING!

- Before replacing the switch, ensure that the system is powered off. Otherwise, electric shocks may occur.
- After the system powers off, there will still be the remaining electricity and heat which may cause electric shocks and body burns. Please wear personal protective equipment (PPE) and begin servicing the system 15 minutes after power off.
- Only qualified person can perform the maintenance for the device.

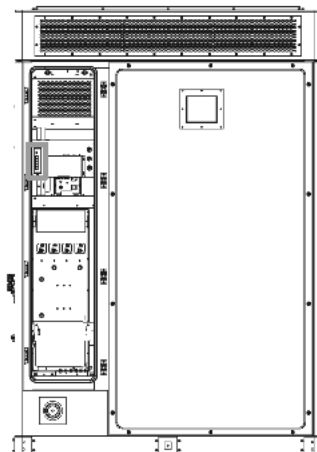

Figure 14-1 Position of the switch (rear view)

Procedure

Step 1: Use keys to open the rear door.

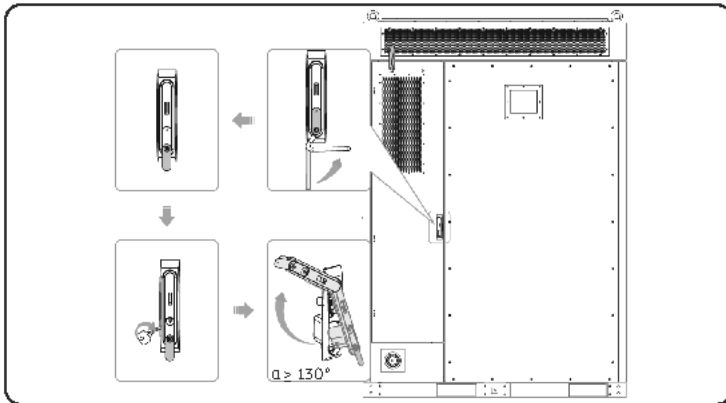

Figure 14-2 Opening the rear door

NOTICE!

- Please keep the keys properly.

Step 2: Remove the Switch, EMS and the cables on the metal plate.

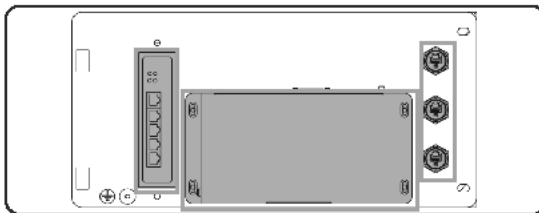

Figure 14-1 Wiring connection area

Step 3: Unscrew the screws on the metal plate, remove the cables on the back of the metal plate, and then remove the Switch and the metal plate together.

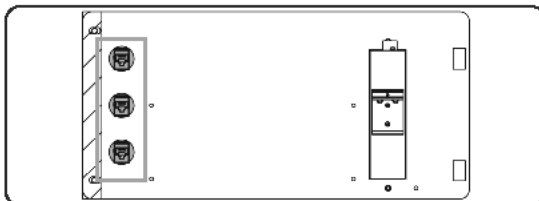

Figure 14-2 Sheet metal wiring area (rear view)

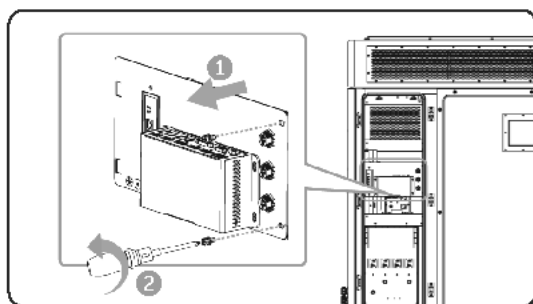

Figure 14-3 Removing the sheet metal

Step 4: Remove the Switch from the sheet metal.

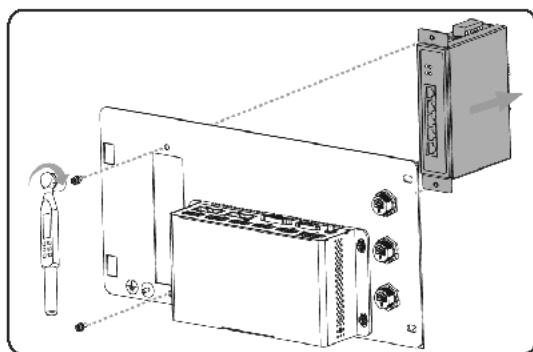

Figure 14-4 Removing the Switch from the sheet metal

Step 5: Remove the Switch from the holder.

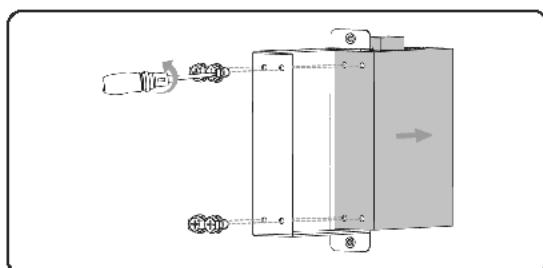

Figure 14-5 Removing the Switch

Step 6: Install a new or repaired Switch to the holder.

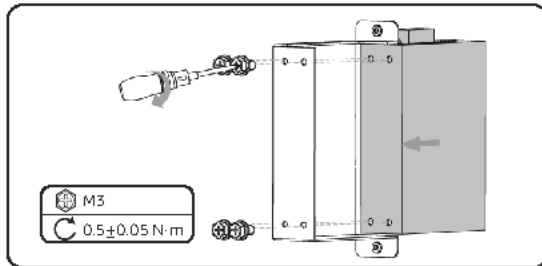

Figure 14-6 Installing the new Switch

Step 7: Install the Switch with the holder on the sheet metal.

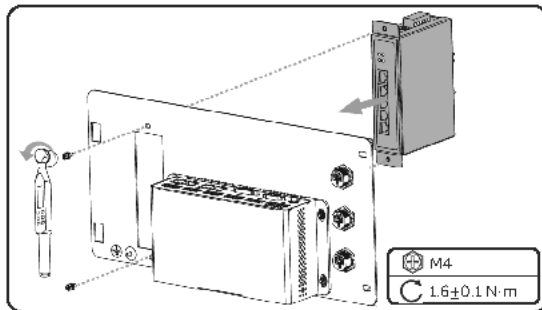

Figure 14-7 Installing the Switch

Step 8: Connect the cables on the back of the sheet metal and install the sheet metal with the Switch to the cabinet.

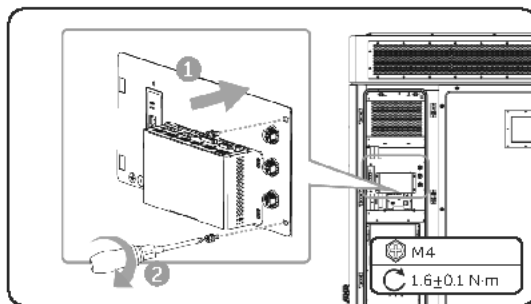

Figure 14-8 Installing the sheet metal

Step 9: Connect the cables of EMS1000, Switch and cables on front of the sheet metal according to silk screen and cable markings.

Step 10: Close the door after the device has been started.

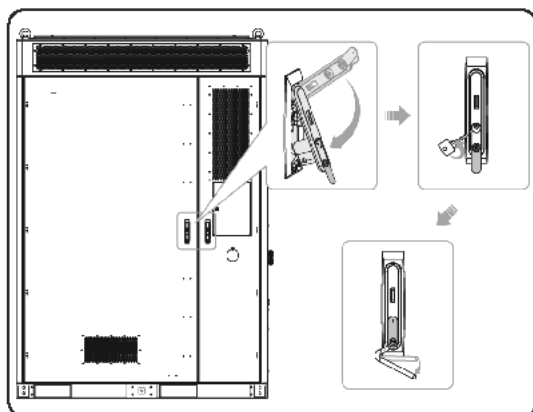

Figure 14-9 Closing the door

NOTICE!

- Please properly keep the key.

Checking after replacement

Step 1: Power on the system. For details, refer to "2.4 Power On".

Step 2: Check whether the indicator on the switch is flashing green light.

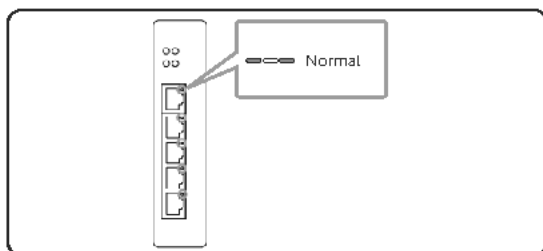
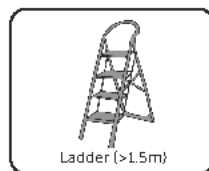
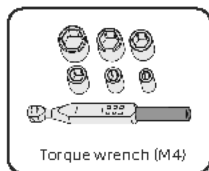
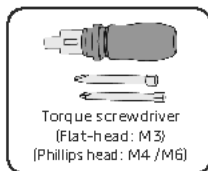

Figure 14-10 Switch normal operation indicator

15 Replacement of I/O Module

Prerequisites

- Fault locating:
 - a. View alarm information via cabinet screen, EMS1000 webpage or SolaXCloud App.
 - b. Refer to the alarm handling suggestions in the alarm details.
 - c. Contact SolaX and order replacement parts.
- Tools: Cross screwdriver, torque wrench, ladder.



WARNING!

- Before replacing the I/O module, ensure that the system is powered off. Otherwise, electric shocks may occur.
- After the system powers off, there will still be the remaining electricity and heat which may cause electric shocks and body burns. Please wear personal protective equipment (PPE) and begin servicing the system 15 minutes after power off.
- Only qualified person can perform the maintenance for the device.

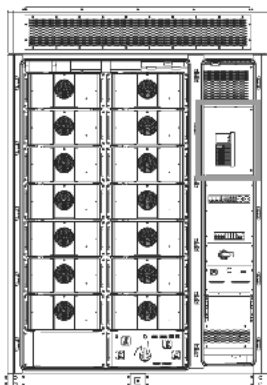

Figure 15-1 Position of the I/O module

Procedure

Step 1: Unscrew the M6 screws and remove the panel.

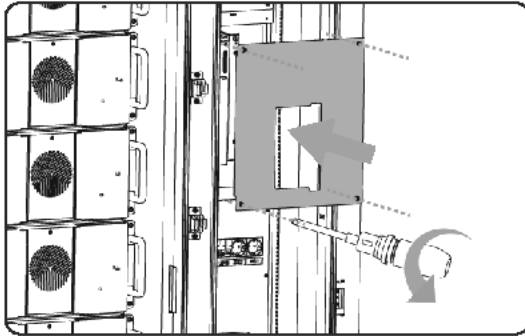

Figure 15-1 Removing panel

Step 2: Remove the cables from the IO module.

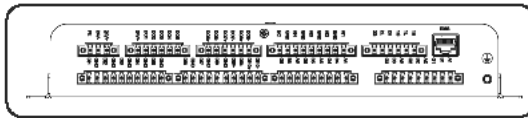

Figure 15-2 IO module wiring area

Step 3: Remove the IO module from the cabinet.

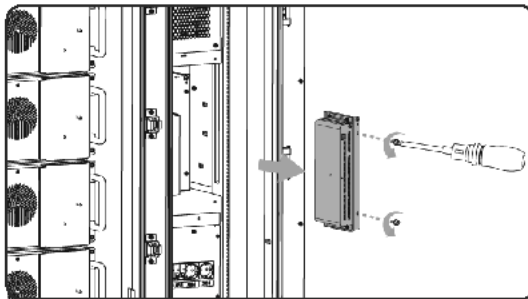

Figure 15-3 Removing the IO module

Step 4: Remove the IO module from the bracket.

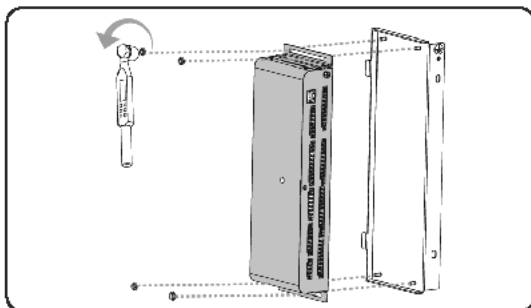

Figure 15-4 Dismantling the IO module

Step 5: Install a new IO module to the bracket.

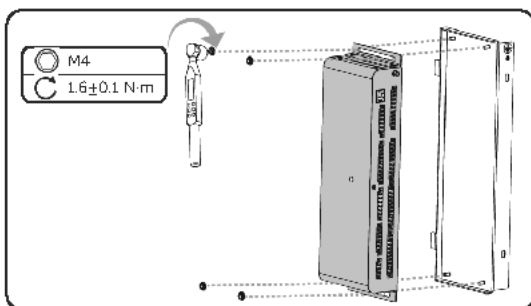

Figure 15-5 Assembling IO modules and brackets

Step 6: Install the IO module into the cabinet.

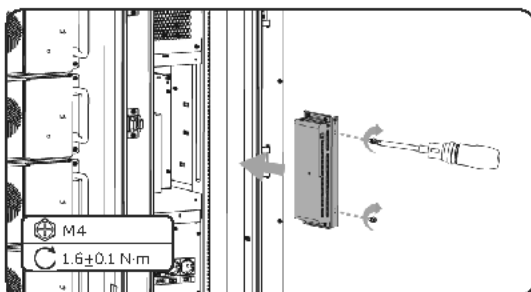

Figure 15-6 Installing IO modules

Step 7: Connect the cables according to the cable labels and silk screen.

Step 8: Mount the panel

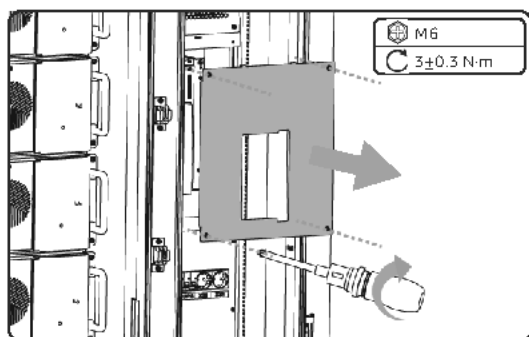

Figure 15-7 Mounting the panel

Checking after replacement

For details of checking procedure after replacement, please refer to "30 Checking after Replacement".

16 Replacement of UPS

Prerequisites

- Fault locating:
 - a. View alarm information via cabinet screen, EMS1000 webpage or SolaXCloud App.
 - b. Refer to the alarm handling suggestions in the alarm details.
 - c. Contact SolaX and order replacement parts.
- Tools: Cross screwdriver, ladder.

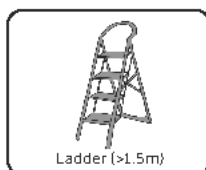
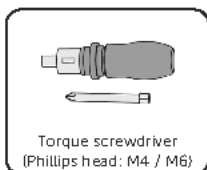

- At least two persons are required to replace the component.

WARNING!

- Before replacing the UPS, ensure that the system is powered off. Otherwise, electric shocks may occur.
- After the system powers off, there will still be the remaining electricity and heat which may cause electric shocks and body burns. Please wear personal protective equipment (PPE) and begin servicing the system 15 minutes after power off.

NOTICE!

- The replaced devices should be sent back to the local SolaX warehouse.

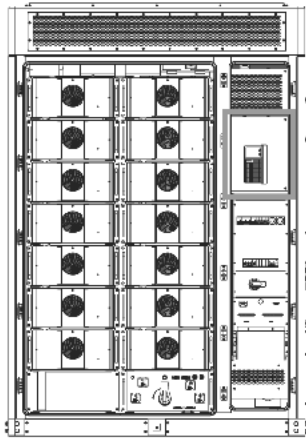

Figure 16-1 Position of the UPS

Procedure

Step 1: Unscrew the M6 screws and remove the panel.

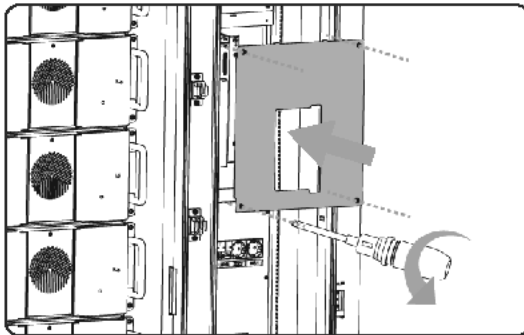

Figure 16-1 Removing the panel

Step 2: Unplug the UPS cables.

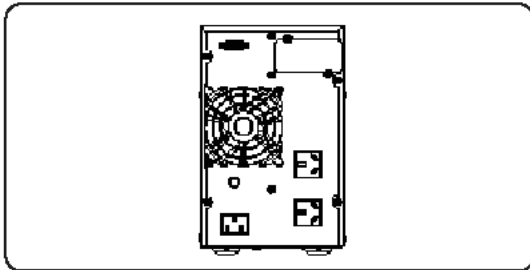

Figure 16-2 UPS Wiring Panel

Step 3: Unscrew the M4 screws and remove the UPS.

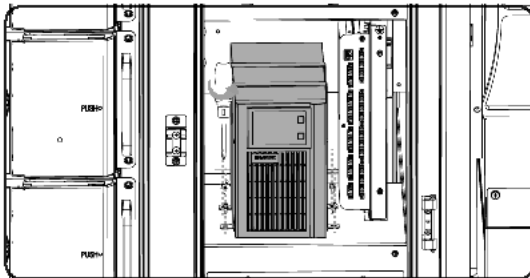

Figure 16-3 Removing the UPS

Step 4: Place a new or maintained UPS in the cabinet and secure with M4 screws.

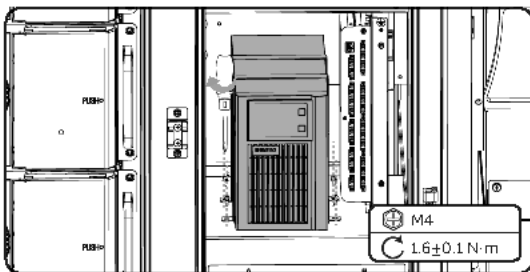

Figure 16-4 Installing the UPS

Step 5: Connect the cables of UPS.

Step 6: Install the panel.

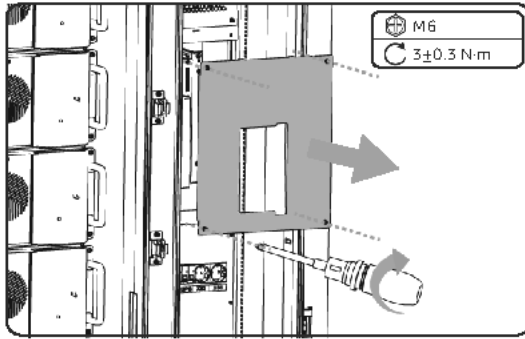

Figure 16-5 Mounting the panel

Checking after replacement

Step 1: Check whether the UPS can be powered on.

Step 2: Check whether the function switching on the UPS screen is normal.

17 Replacement of Air Conditioner

Prerequisites

- Fault locating:
 - a. View alarm information via cabinet screen, EMS1000 webpage or SolaXCloud App.
 - b. Refer to the alarm handling suggestions in the alarm details.
 - c. Contact SolaX and order replacement parts.
- Tools: Cross screwdriver, hexalobular key, ladder.

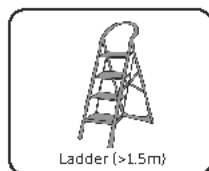
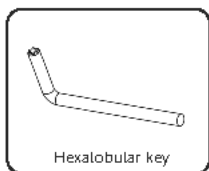
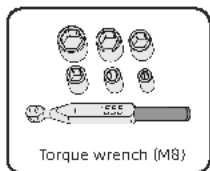

- At least two persons are required to replace the component.

WARNING!

- Before replacing the air conditioner, ensure that the system is powered off. Otherwise, electric shocks may occur.
- After the system powers off, there will still be the remaining electricity and heat which may cause electric shocks and body burns. Please wear personal protective equipment (PPE) and begin servicing the system 15 minutes after power off.
- Only qualified person can perform the maintenance for the device.

NOTICE!

- The replaced devices should be sent back to the local SolaX warehouse.

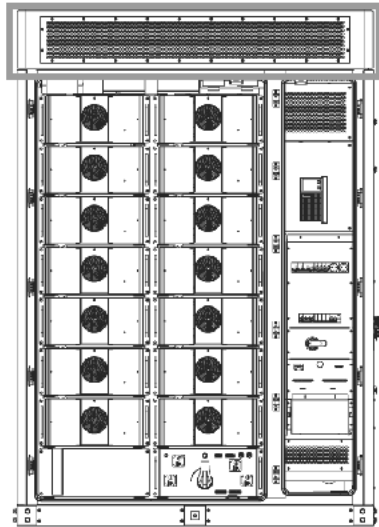

Figure 17-1 Position of the air conditioner

Procedure

Step 1: Remove the cabinet cover.

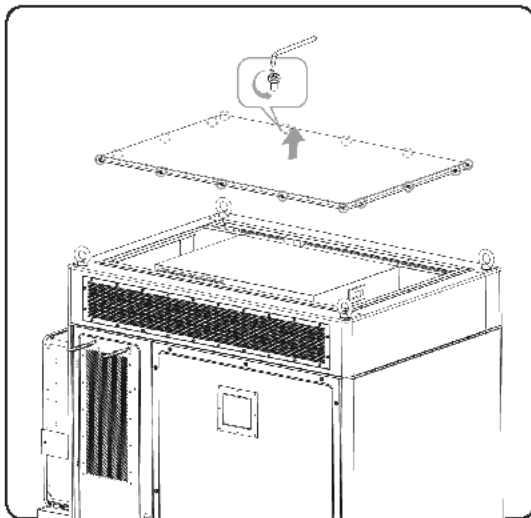

Figure 17-1 Remove the upper cover of the cabinet

Step 2: Remove the cables on the air conditioner.

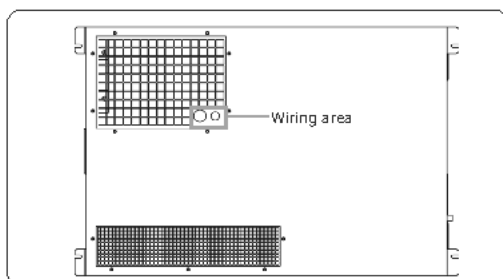

Figure 17-2 Removing cables (top view)

Step 3: Unscrew the M8 screws and remove the air conditioner.

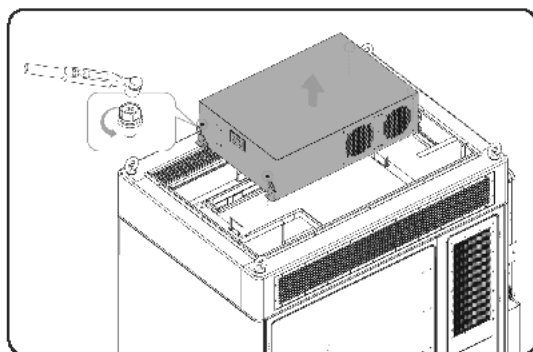

Figure 17-3 Removing air conditioner

Step 4: Install new air conditioner, fix the air conditioner with M8 screws, and connect the cables.

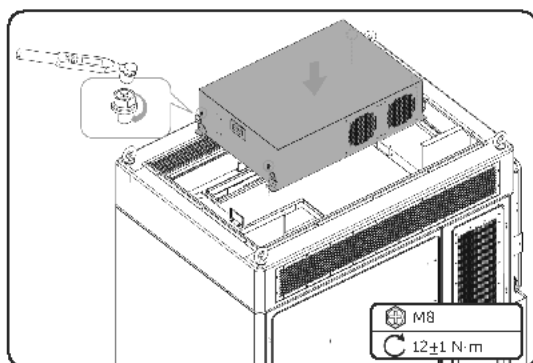

Figure 17-4 Installing the new air conditioner

Step 5: Install the upper cover of cabinet.

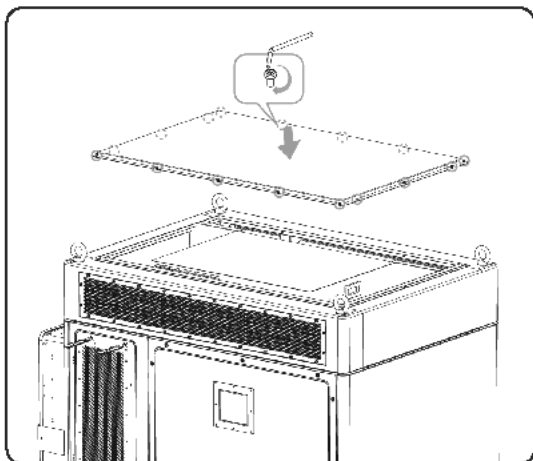

Figure 17-5 Installing top cover

Checking after replacement

For details of checking procedure after replacement, please refer to "30 Checking after Replacement".

18 Replacement of Temperature and Humidity Sensor

Prerequisites

- Fault locating:
 - a. View alarm information via cabinet screen, EMS1000 webpage or SolaXCloud App.
 - b. Refer to the alarm handling suggestions in the alarm details.
 - c. Contact SolaX and order replacement parts.
- Tools: Flat-head screwdriver, ladder.

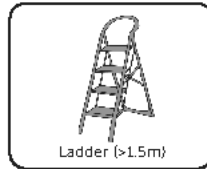
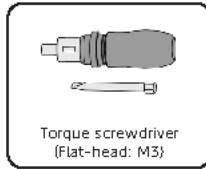

WARNING!

- Before replacing the temperature and humidity sensor, ensure that the system is powered off. Otherwise, electric shocks may occur.
- After the system powers off, there will still be the remaining electricity and heat which may cause electric shocks and body burns. Please wear personal protective equipment (PPE) and begin servicing the system 15 minutes after power off.
- Only qualified person can perform the maintenance for the device.

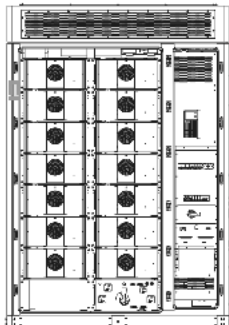

Figure 18-1 Position of the temperature and humidity sensor

Procedure

- Step 1:** Loosen the M3 fixing screws of the terminal blocks and remove the cables of temperature and humidity sensor.

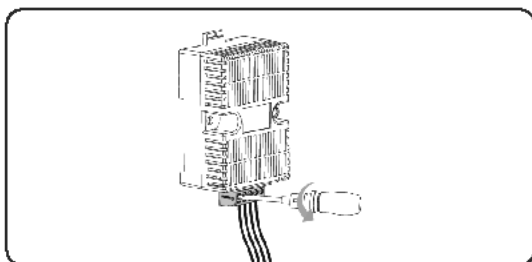

Figure 18-1 Removing cables

- Step 2:** Unscrew and remove the fixture outward along the guide rail, and then slide the temperature and humidity sensor out.

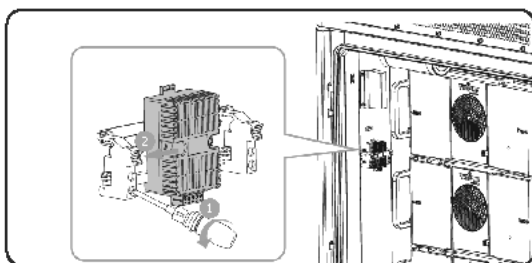

Figure 18-2 Removing temperature and humidity sensor

- Step 3:** Slide the new temperature and humidity sensor and fixture along the guide rail and lock the screw of the fixture.

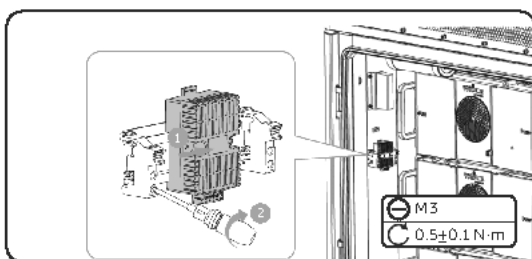

Figure 18-3 Installing temperature and humidity sensor

Step 4: Connect the cables according to the cable labels.

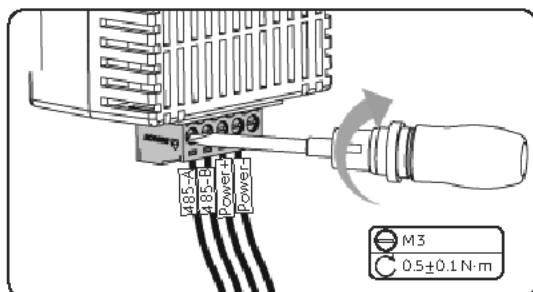

Figure 18-4 Connecting the cables

Checking after replacement

Step 1: Power on the system. For details, refer to "2.4 Power On".

Step 2: Check whether the temperature and humidity is in normal range (-30°C~+55°C, 0-95%RH) via EMS1000 webpage or SolaXCloud App.

19 Replacement of Door Sensor

Prerequisites

- Fault locating:
 - a. View alarm information via cabinet screen, EMS1000 webpage or SolaXCloud App.
 - b. Refer to the alarm handling suggestions in the alarm details.
 - c. Contact SolaX and order replacement parts.
- Tools: Cross screwdriver, ladder.



WARNING!

- Before replacing the door sensor, ensure that the system is powered off. Otherwise, electric shocks may occur.
- After the system powers off, there will still be the remaining electricity and heat which may cause electric shocks and body burns. Please wear personal protective equipment (PPE) and begin servicing the system 15 minutes after power off.
- Only qualified person can perform the maintenance for the device.

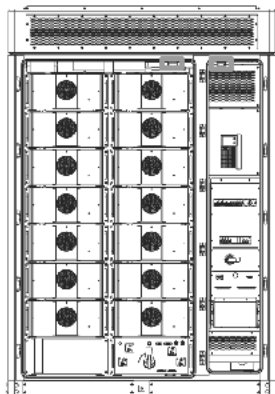

Figure 19-1 Position of the door sensor 1 and door sensor 2 (front view)

Step 3: Connect the cable and install a new door sensor, snap the cover.

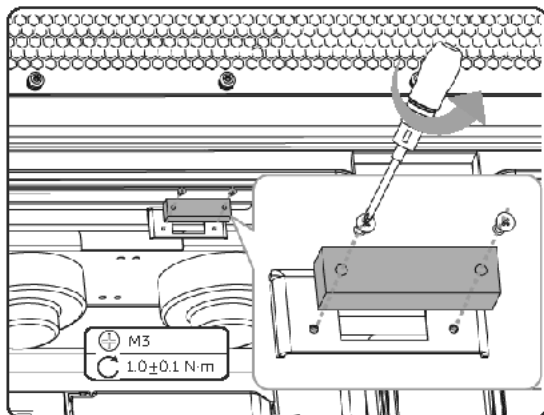

Figure 19-4 Installing the door sensor

Checking after replacement

For details of checking procedure after replacement, please refer to "30 Checking after Replacement".

20 Replacement of Smoke Detector and Temperature Sensor

Prerequisites

- Fault locating:
 - a. View alarm information via cabinet screen, EMS1000 webpage or SolaXCloud App.
 - b. Refer to the alarm handling suggestions in the alarm details.
 - c. Contact SolaX and order replacement parts.
- Tools: Ladder.

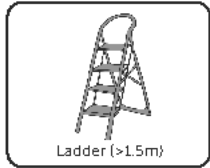

WARNING!

- Before replacing the smoke detector and temperature sensor, ensure that the system is powered off. Otherwise, electric shocks may occur.
- After the system powers off, there will still be the remaining electricity and heat which may cause electric shocks and body burns. Please wear personal protective equipment (PPE) and begin servicing the system 15 minutes after power off.
- Only qualified person can perform the maintenance for the device.

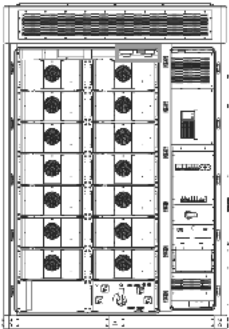

Figure 20-1 Position of the smoke detector and temperature sensor

Procedure

Step 1: Loosen the cover of the smoke detector and temperature sensor counterclockwise.

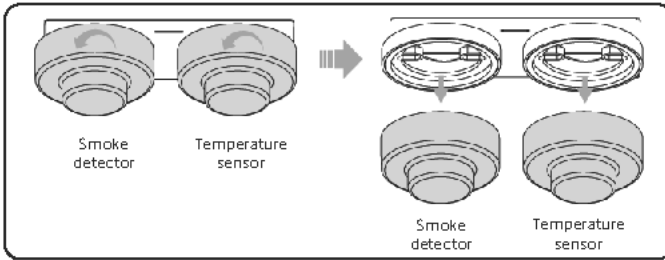

Figure 20-2 Removing the smoke detector and temperature sensor

Step 2: Install the new smoke detector and temperature sensor on the bases.

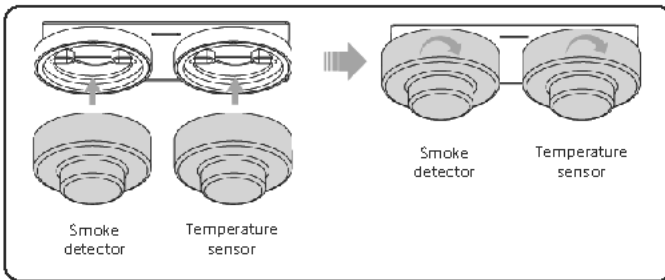

Figure 20-3 Installing the smoke detector and temperature sensor

Checking after replacement

For details of checking procedure after replacement, please refer to "30 Checking after Replacement".

21 Replacement of Distribution Box

Prerequisites

- Fault locating:
 - a. View alarm information via cabinet screen, EMS1000 webpage or SolaXCloud App.
 - b. Refer to the alarm handling suggestions in the alarm details.
 - c. Contact SolaX and order replacement parts.
- Tools: Cross screwdriver, torque wrench

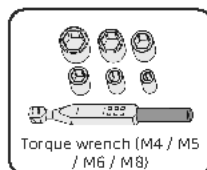
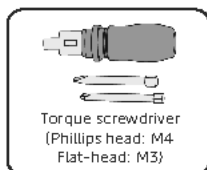

- At least two persons are required to replace the component.

WARNING!

- Before replacing the distribution box, ensure that the system is powered off. Otherwise, electric shocks may occur.
- After the system powers off, there will still be the remaining electricity and heat which may cause electric shocks and body burns. Please wear personal protective equipment (PPE) and begin servicing the system 15 minutes after power off.
- Only qualified person can perform the maintenance for the device.

NOTICE!

- The replaced devices should be sent back to the local SolaX warehouse.

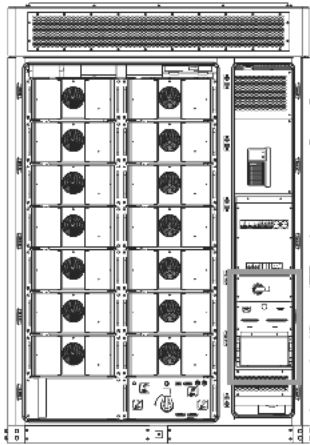

Figure 21-1 Position of the distribution box

Procedure

Step 1: Disconnect EPS cables.

- a. Loosen the M4 screws and remove the cover. Unscrew the M8 screws with torque wrench, disconnect the L1/L2/L3/N cables, and screw the M8 screws back.

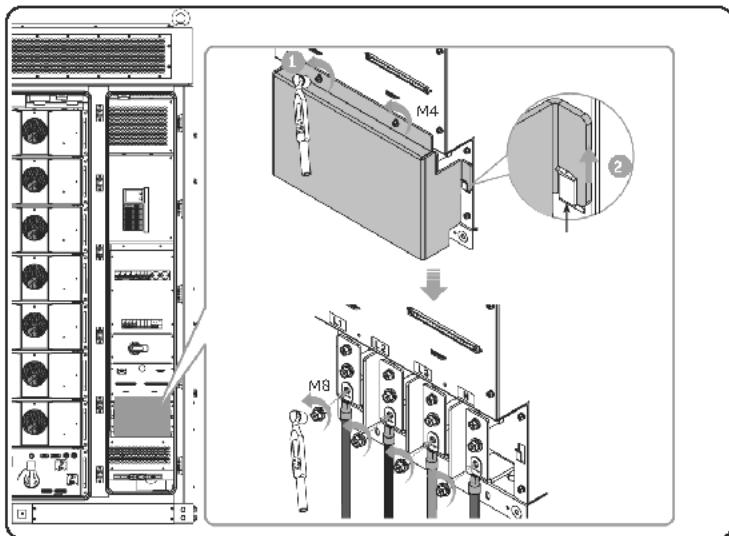

Figure 21-2 Disconnecting EPS cables

NOTICE!

- Please keep the M4 screws and cover properly.

- b. Unscrew the M5 and M6 screws and loosen the M5 butterfly nuts.

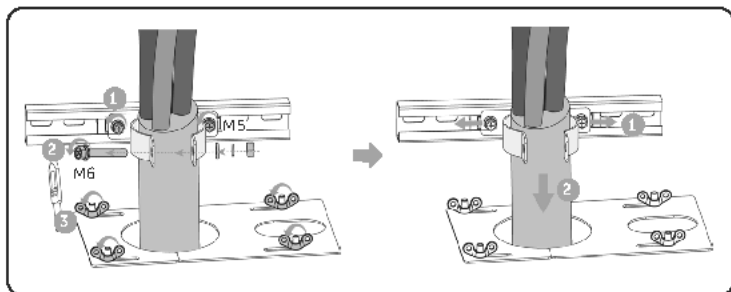

Figure 21-3 Removing the EPS cables

NOTICE!

- Please keep the screw, washers and nut properly.

- c. Pull the EPS cables out from **a** or **b**.

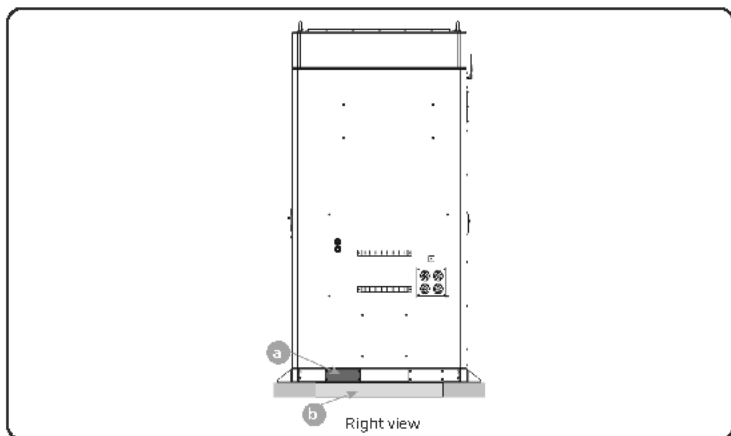

Figure 21-4 Pulling EPS cables out

Step 2: Loosen the M3 fixing screws of the terminal blocks and remove the terminal blocks.

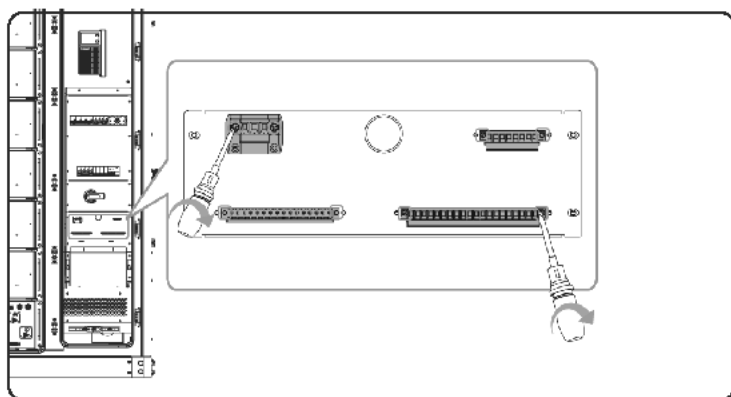

Figure 21-5 Removing the terminals

Step 3: Use keys to open the rear door.

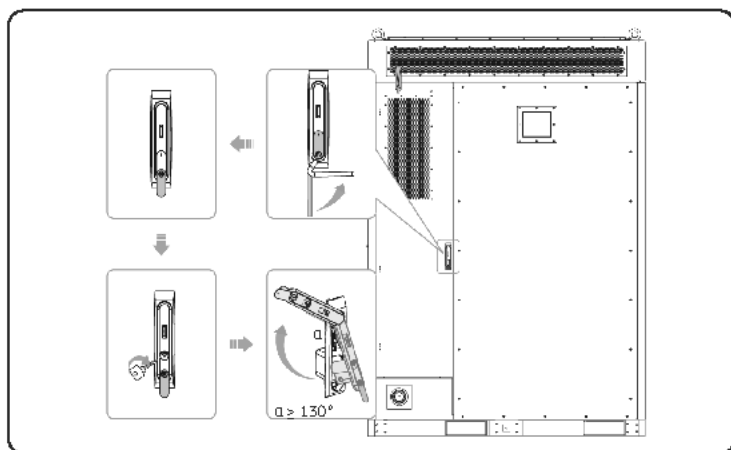

Figure 21-6 Opening rear door

NOTICE!

- Please keep the keys properly.

Step 4: Disconnect Grid cables.

- a. Loosen the M5 screws and remove the cover. Unscrew the M8 screws, disconnect the L1/L2/L3/N cables, and screw the M8 screws back.

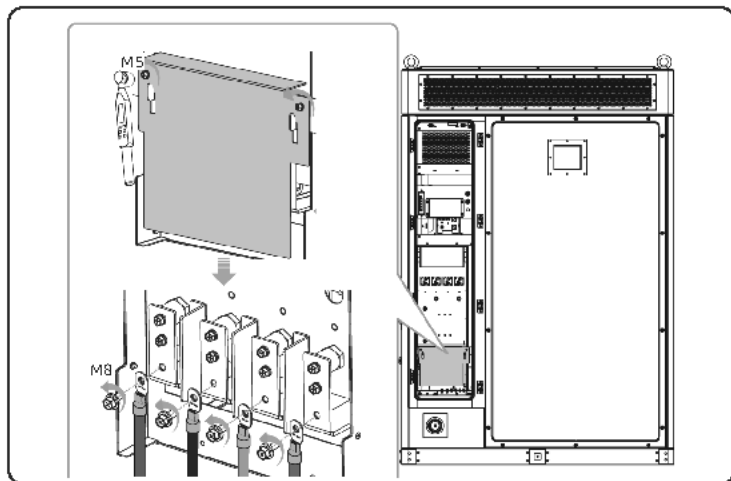

Figure 21-7 Disconnecting Grid cable

NOTICE!

- Please keep the M5 screws and cover properly.

- b. Unscrew the M5 and M6 screws and loosen the M5 butterfly nuts.

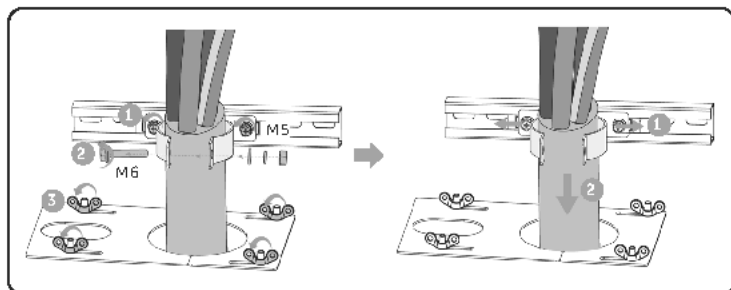

Figure 21-8 Removing the Grid cables

NOTICE!

- Please keep the screw, washers and nut properly.

- c. Pull the Grid cables out from **a** or **b**.

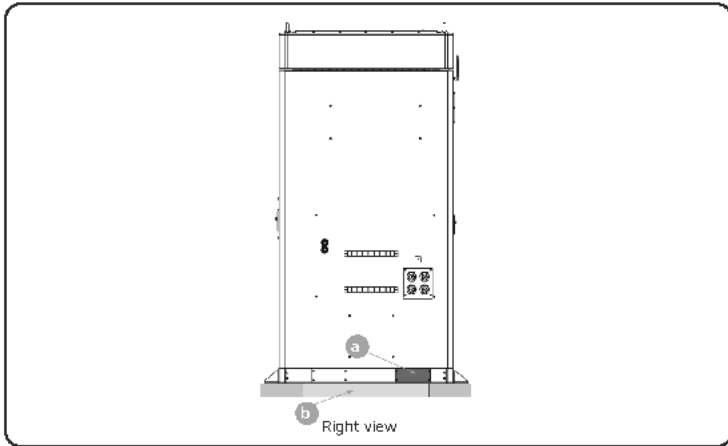

Figure 21-9 Pulling Grid cables out

- Step 5:** Unscrew the M5 screw on the distribution box and take out the distribution box.

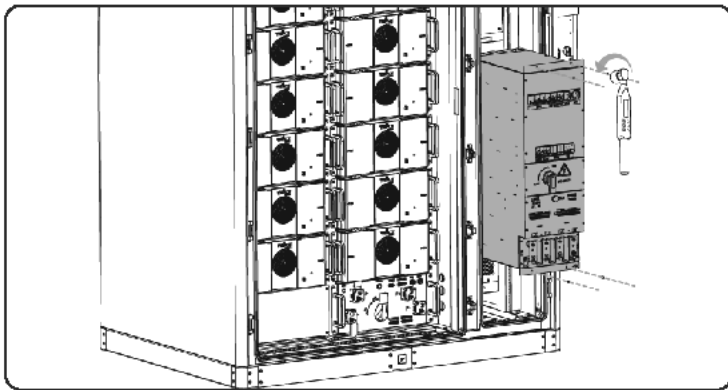

Figure 21-10 Removing distribution box

Step 6: Install new distribution box.

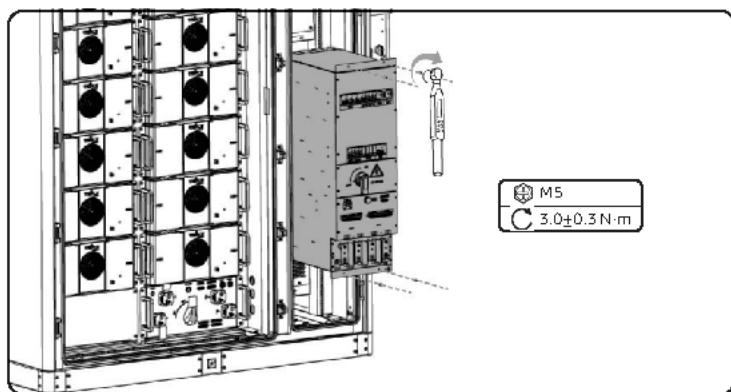

Figure 21-11 Installation of distribution box

NOTICE!

- If the jacket of the cable is damaged or the terminals are deformed and so on, please replace the cable. The cable and terminal requirements are shown below.

Table 21-1 Cable requirements



No.	Required Material	Type	Conductor Cross-section
1	Grid cable 	Five-core copper cable * The conductor cross-section for L1, L2, L3 and N cables is 35 mm ² ; the conductor cross-section for PE wire is 16 mm ² .	35 mm ² * 4 + 16 mm ² * 1
2	EPS cable 	Four-core copper cable	35 mm ² * 4

Table 21-2 Terminal requirements

No.	Required Material	Type
1	Ring terminal 	TLK16-8 ring terminal

Step 7: Connect EPS cables.

- a. Thread the EPS cables through option a or b from the outside to the inside.

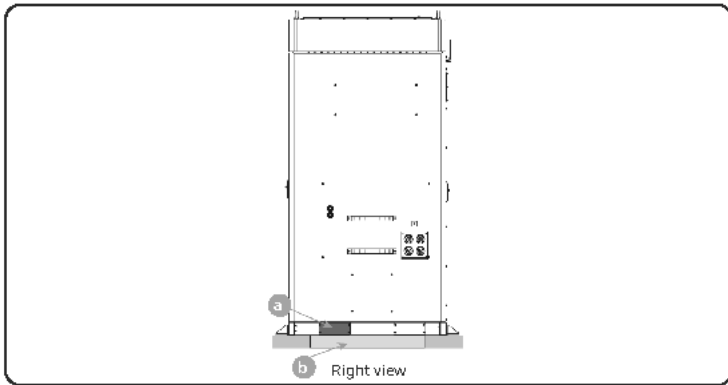

Figure 21-12 Threading EPS cables

- b. Thread the EPS cables through the clamp

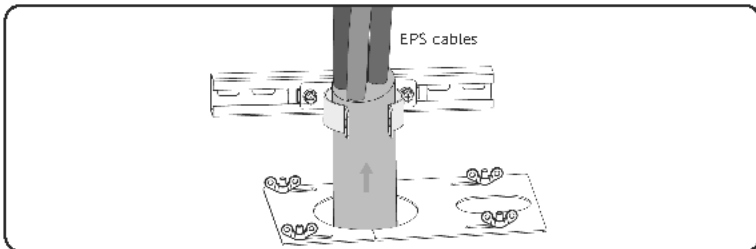

Figure 21-13 Threading EPS cables

- c. There are four bars in the connection area, each bar has two holes, and it is recommended to connect cables in the green area.

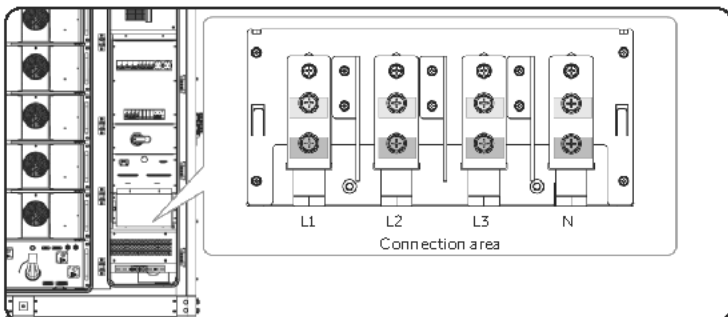

Figure 21-14 Connection area

- d. Insert M8 screws to secure and connect the L1/L2/L3/N cables to the cable interface, and then tighten them.

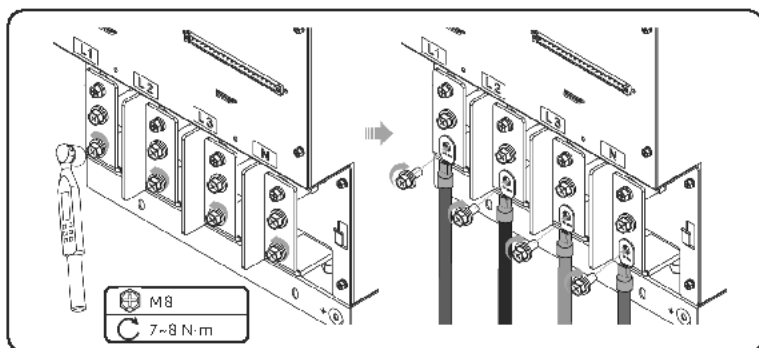

Figure 21-15 Connecting L1, L2, L3 and N cables

- e. Insert and tighten M5 and M6 screws (torque for M5: 3 ± 0.3 N·m; torque for M6: 5 ± 0.5 N·m), and then fully tighten M5 butterfly nuts.

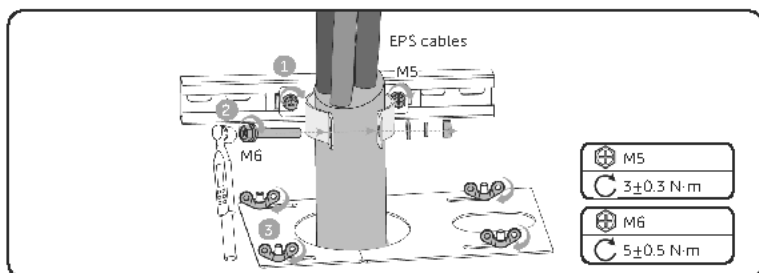

Figure 21-16 Tightening screws

- f. Attach the cover, and insert and tighten the M4 screws.

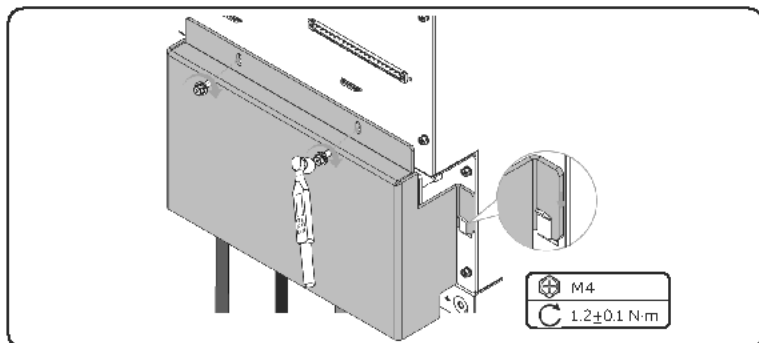

Figure 21-17 Securing cover

Step 8: Connect Grid cables.

- a. Use keys to open the rear door.

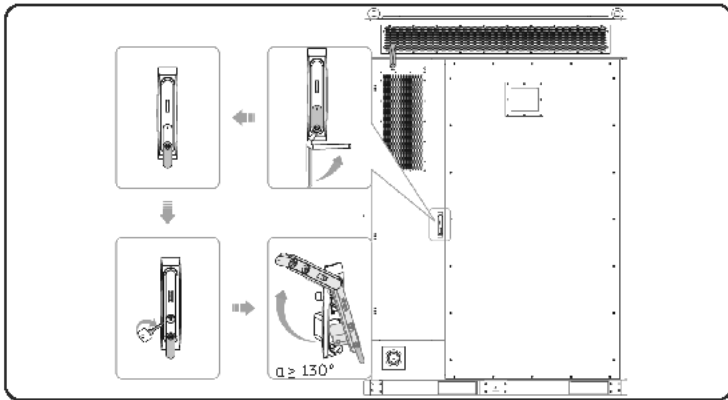

Figure 21-18 Opening rear door

Step 9: Thread the Grid cables through option a or b from the outside to the inside.

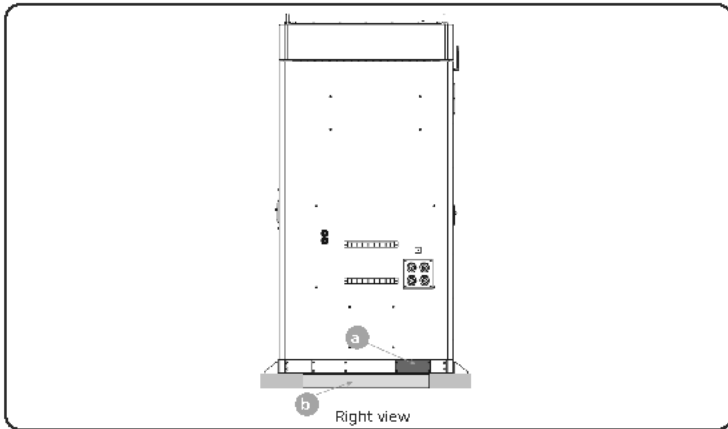

Figure 21-19 Threading grid cables

- b. Thread the grid cables through the clamp.

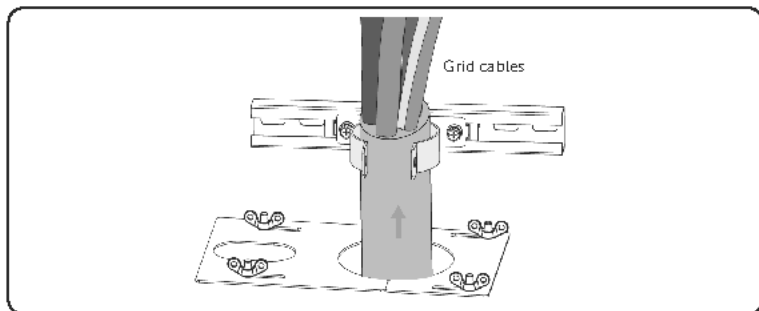

Figure 21-20 Threading grid cables

- c. There are four bars in the connection area, each bar has two holes, and it is recommended to connect cables in the green area.

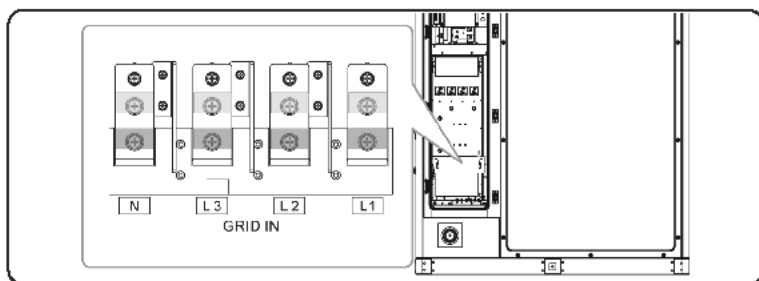

Figure 21-21 Connection area

- d. Insert M8 screws (Part K) to secure and connect the assembled L1/L2/L3/N cables to the cable interface, and then tighten them (torque: 12 ± 1 N·m).

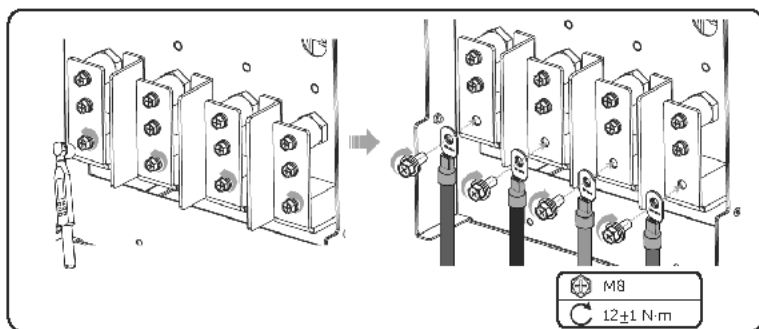

Figure 21-22 Connecting L1, L2, L3 and N cables

- e. Insert and tighten M5 and M6 screws (torque for M5: 3 ± 0.3 N·m; torque for M6: 5 ± 0.5 N·m), and then fully tighten M5 butterfly nuts.

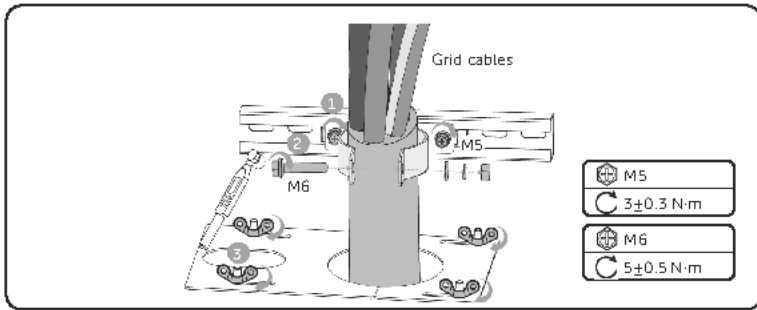

Figure 21-23 Tightening screws

- f. There are two M8 screws, and either one of them can be connected to the PE wire. Hence, unscrew a M8 screw using a torque wrench, connect the assembled PE wire to the copper bar, and then tighten it (torque: 12 ± 1 N·m).

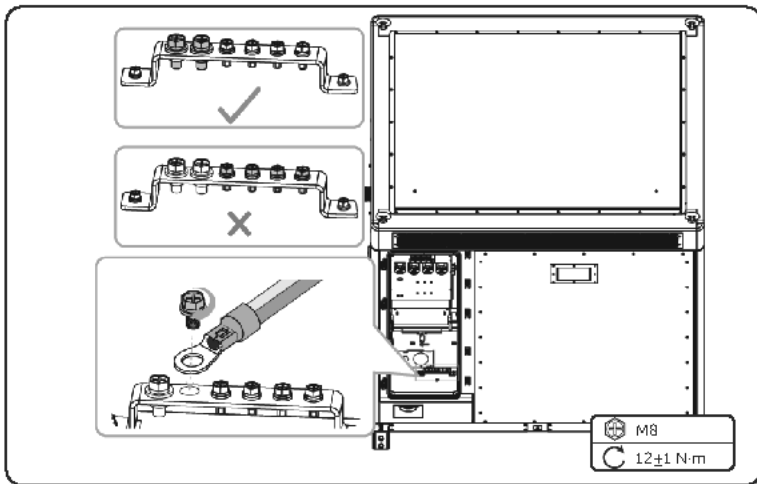

Figure 21-24 Connecting PE wire

- g. Reattach the cover over the hooks to the cabinet, and then correctly insert and tighten M5 screws (torque: 3.0 ± 0.3 N·m).

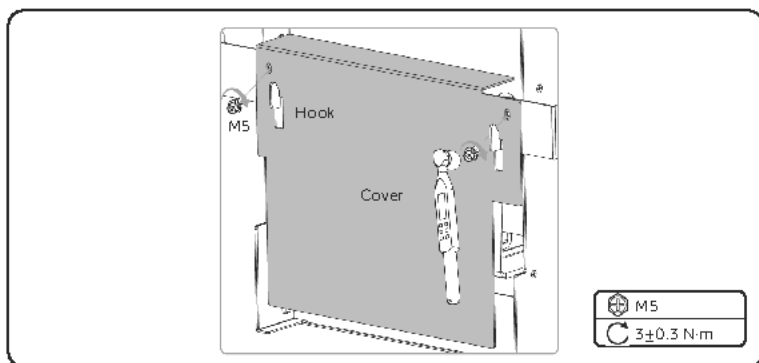

Figure 21-25 Reattaching cover

- Step 10:** Connect the communication cables and fasten the M3 fixing screws of the terminal blocks.

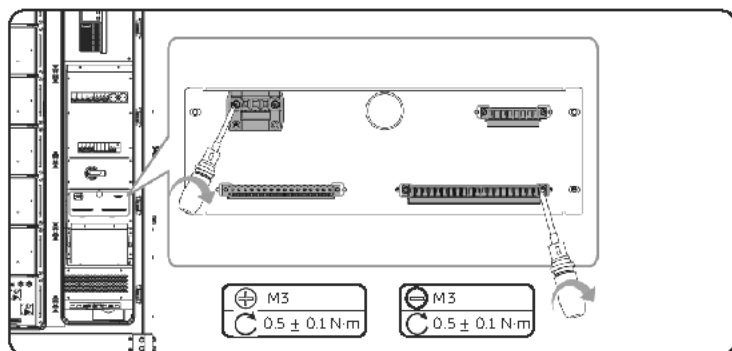

Figure 21-26 Connecting the cables

NOTICE!

- Must clean the materials, such as metal parts, screws, etc., in the cabinet after finishing wiring.

Step 11: Lay the fireproof mud to plug the cable threading holes on both front and rear sides of the cabinet.

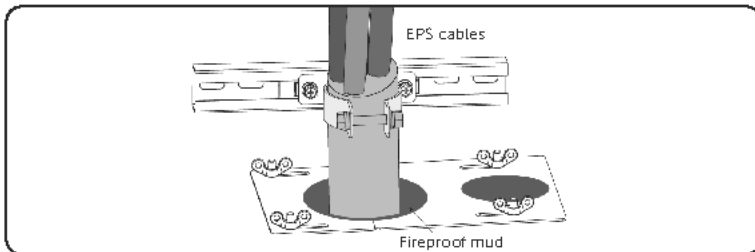

Figure 21-27 Plugging the cables threading hole on the front side

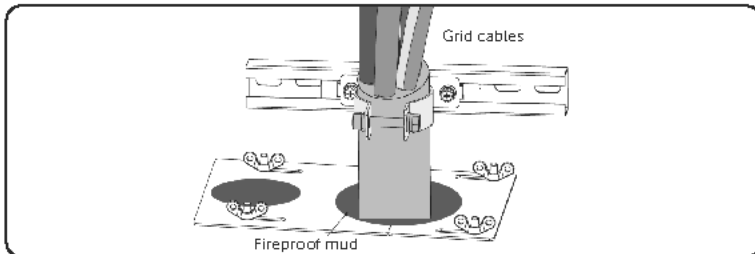

Figure 21-28 Plugging the cables threading hole on the rear side

NOTICE!

Notice for fireproofing mud:

- Take out the fireproof mud delivered with the cabinet and knead it into a ball shape. In the case of the low temperature, place it into warm water, of which the temperature range is between 40°C and 70 °C, with its package until it is soft.
- Clean the area around the cable threading hole before sealing it.
- The fireproof mud should be evenly spread, embedded, or filled in the cable threading hole. If such a hole is too large, a fireproofing board can be placed to enhance fire protection before using the mud.
- The fireproof mud needs to be cured after sealing the cable threading hole. Prevent water from entering and colliding during curing.

Step 12: Close the rear door.

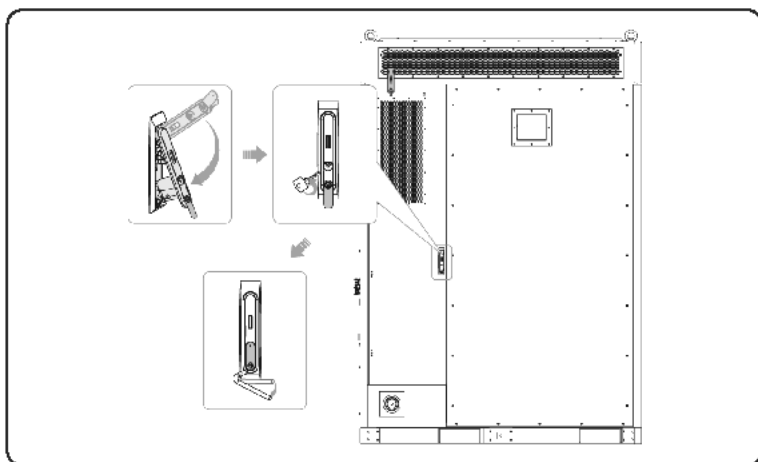

Figure 21-29 Closing the rear door

NOTICE!

- Please properly keep the key.

Checking after replacement

For details of checking procedure after replacement, please refer to "30 Checking after Replacement".

22 Replacement of SPD Module

Prerequisites

- Fault locating:
 - a. View alarm information via cabinet screen, EMS1000 webpage or SolaXCloud App.
 - b. Refer to the alarm handling suggestions in the alarm details.
 - c. Contact SolaX and order replacement parts.
- Tools: Torque screwdriver, torque wrench.

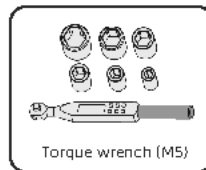
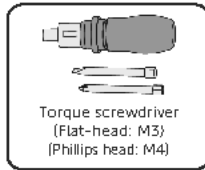

WARNING!

- Before replacing the SPD module, ensure that the system is powered off. Otherwise, electric shocks may occur.
- After the system powers off, there will still be the remaining electricity and heat which may cause electric shocks and body burns. Please wear personal protective equipment (PPE) and begin servicing the system 15 minutes after power off.
- Only qualified person can perform the maintenance for the device.

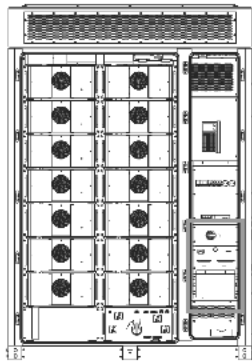

Figure 22-1 Position of the SPD module

Procedure

Step 1: Unscrew the M4 screws on the front panel of the distribution box and remove the panel.

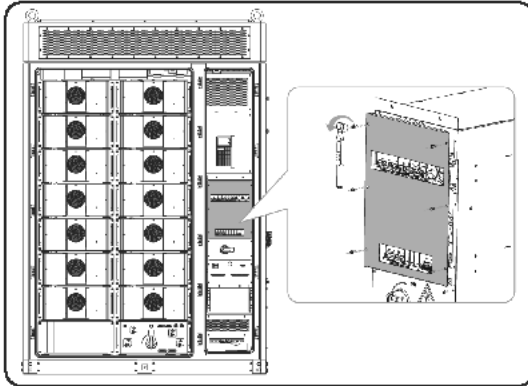

Figure 22-2 Removing the front panel

Step 2: Loosen the screws, and remove the cables from the SPD module.

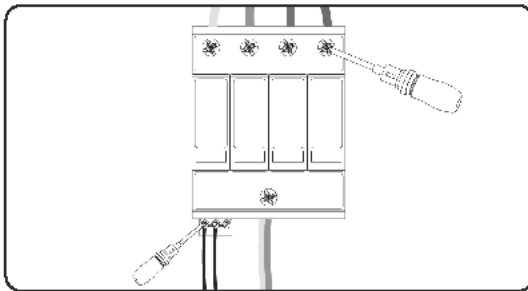

Figure 22-3 Removing the SPD module

Step 3: Use a screwdriver to pry up the clip on the SPD and pull the SPD module out upwards.

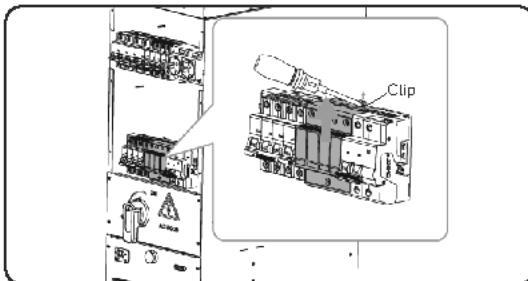

Figure 22-4 Removing the SPD module

Step 4: Pry the clip, install a new SPD module.

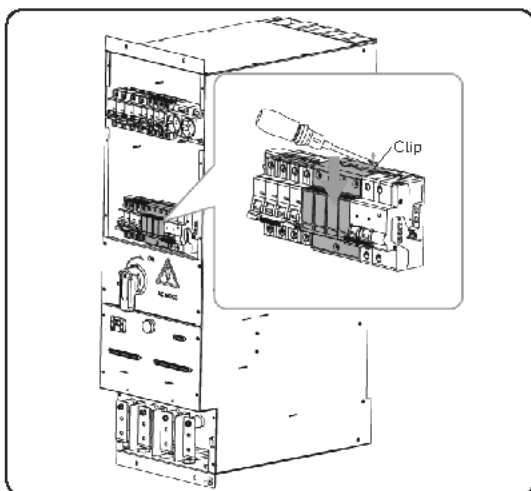

Figure 22-5 Installing the SPD module

Step 5: Connect the cables according to the cable labels.

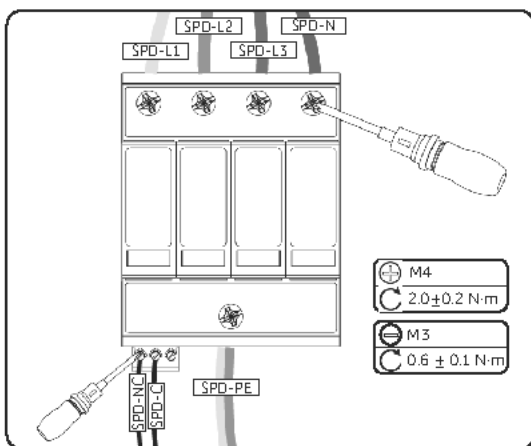

Figure 22-6 Connecting the SPD module cables

Step 6: Install the panel of the distribution box.

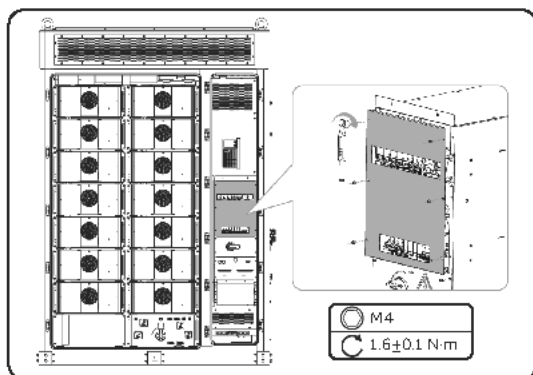

Figure 22-7 Mounting the panel

Checking after replacement

Step 1: Power on the system. For details, refer to "2.4 Power On".

Step 2: Check whether the indicator of the SPD module is green light.

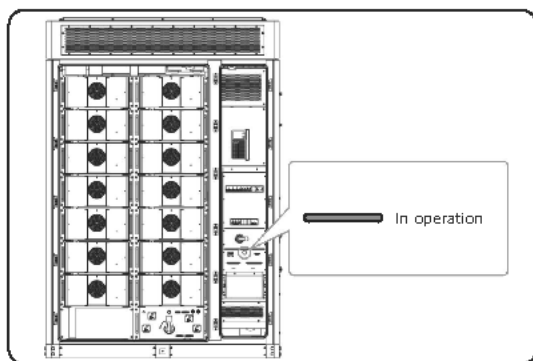

Figure 22-8 SPD module indicator

Step 3: Check whether the status of the SPD module is normal via EMS1000 webpage or SolaXCloud App.

23 Replacement of Audible and Visible Alarm

Prerequisites

- Fault locating:
 - a. View alarm information via cabinet screen, EMS1000 webpage or SolaXCloud App.
 - b. Refer to the alarm handling suggestions in the alarm details.
 - c. Contact SolaX and order replacement parts.
- Tools: Cross screwdriver, ladder.

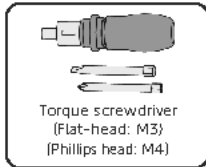

WARNING!

- Before replacing the audible and visible alarm, ensure that the system is powered off. Otherwise, electric shocks may occur.
- After the system powers off, there will still be the remaining electricity and heat which may cause electric shocks and body burns. Please wear personal protective equipment (PPE) and begin servicing the system 15 minutes after power off.
- Only qualified person can perform the maintenance for the device.

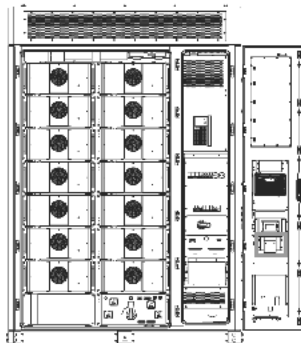

Figure 23-1 Position of the audible and visible alarm

Procedure

Step 1: Remove the cover of the audible and visual alarm.

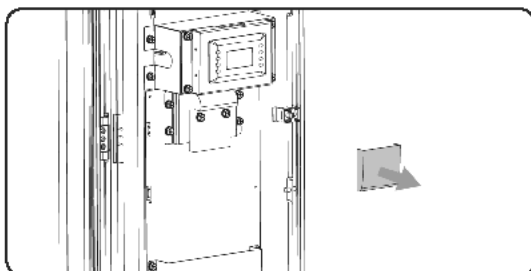

Figure 23-1 Removing the cover

Step 2: Disconnect the cables and unscrew the M4 screw to remove the audible and visual alarm.

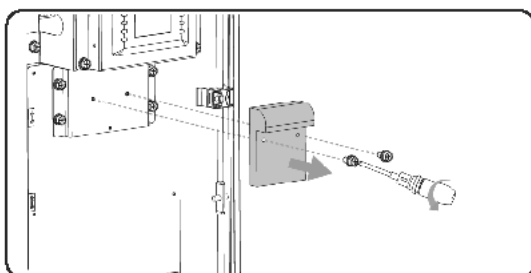

Figure 23-2 Removing audible and visual alarm

Step 3: Install the new audible and visual alarms and connect the cables.

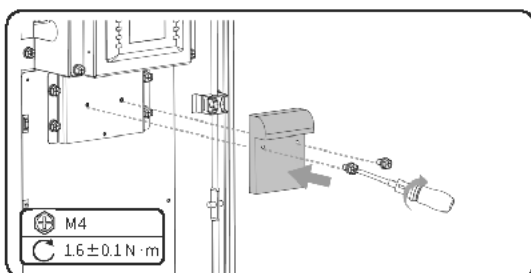

Figure 23-3 Installation of audible and visual alarm

Step 4: Install the cover of audible and visual alarm.

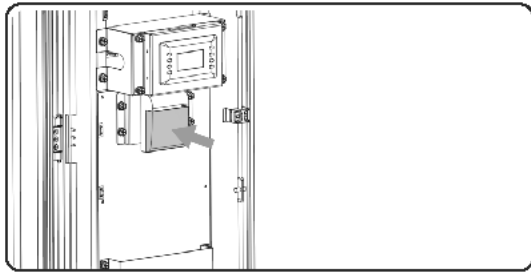

Figure 23-4 Installing cover

Checking after replacement

- Step 1:** Power on the system. For details, refer to "2.4 Power On".
- Step 2:** Use the IO module to control the D03 close, check whether the audible and visible alarm will buzz and light up.

24 Replacement of CO Detector

Prerequisites

- Fault locating:
 - a. View alarm information via cabinet screen, EMS1000 webpage or SolaXCloud App.
 - b. Refer to the alarm handling suggestions in the alarm details.
 - c. Contact SolaX and order replacement parts.
- Tools: Torque screwdriver, ladder.

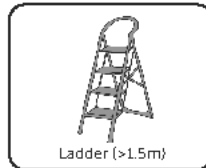

WARNING!

- Before replacing the CO detector, ensure that the system is powered off. Otherwise, electric shocks may occur.
- After the system powers off, there will still be the remaining electricity and heat which may cause electric shocks and body burns. Please wear personal protective equipment (PPE) and begin servicing the system 15 minutes after power off.
- Only qualified person can perform the maintenance for the device.

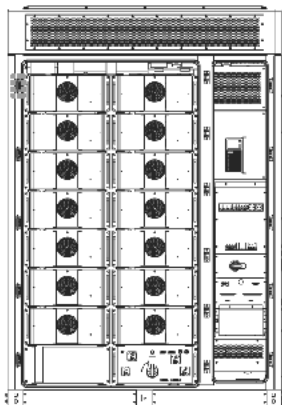

Figure 24-1 Position of the CO detector

Procedure

Step 1: Remove the cables of the CO detector.

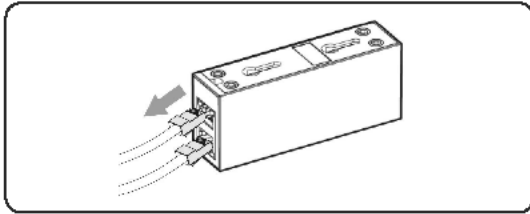

Figure 24-1 Removing cables

Step 2: Unscrew the M4 screws and remove the CO detector from cabinet.

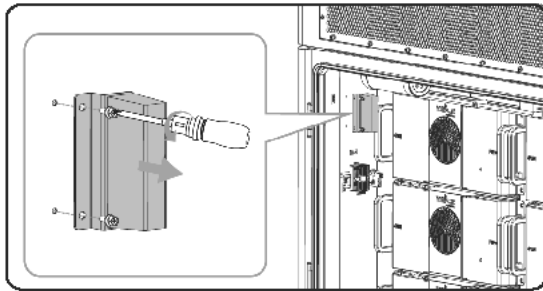

Figure 24-2 Removing the CO detector

Step 3: Unscrew the M4 screws and remove the CO detector from the holder.

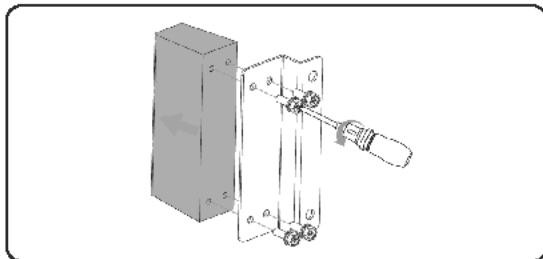

Figure 24-3 Removing the CO detector

Step 4: Install a new CO detector on the holder.

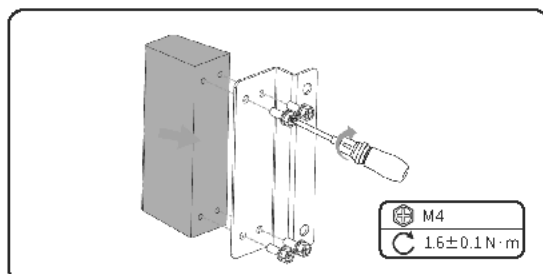

Figure 24-4 Installing the CO detector

Step 5: Install the new CO detector with holder to cabinet and plug the cables.

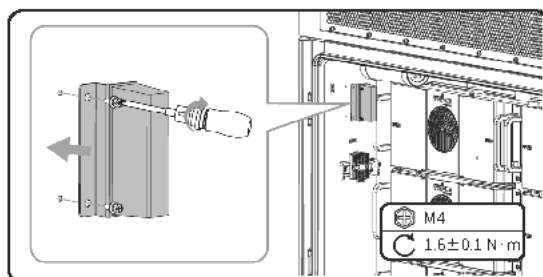

Figure 24-5 Installing the CO detector

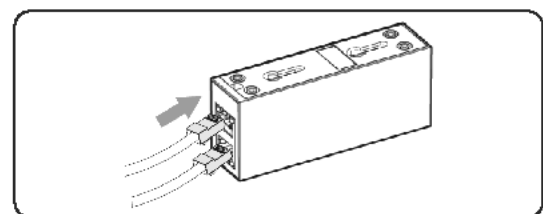

Figure 24-6 Connecting cables

Checking after replacement

For details of checking procedure after replacement, please refer to "30 Checking after Replacement".

25 Replacement of Water Sensor

Prerequisites

- Fault locating:
 - a. View alarm information via cabinet screen, EMS1000 webpage or SolaXCloud App.
 - b. Refer to the alarm handling suggestions in the alarm details.
 - c. Contact SolaX and order replacement parts.
- Tools: Torque screwdriver and torque wrench.

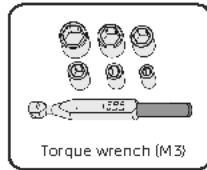
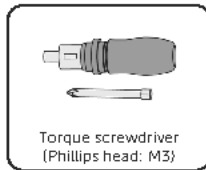

WARNING!

- Before replacing the water sensor, ensure that the system is powered off. Otherwise, electric shocks may occur.
- After the system powers off, there will still be the remaining electricity and heat which may cause electric shocks and body burns. Please wear personal protective equipment (PPE) and begin servicing the system 15 minutes after power off.
- Only qualified person can perform the maintenance for the device.

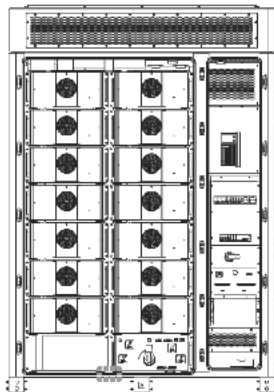

Figure 25-1 Position of the water sensor

Procedure

Step 1: Unscrew the M3 nut to remove the water sensor cable.

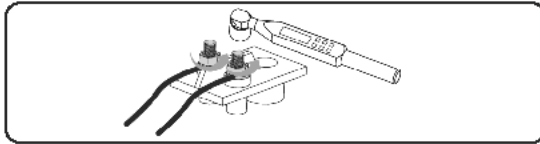

Figure 25-2 Removing the cable

Step 2: Unscrew the M3 screws on the water sensor and remove the water sensor.

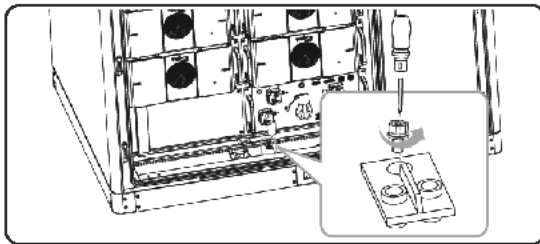

Figure 25-3 Removing the water sensor

Step 3: Install a new water sensor and connect the cables.

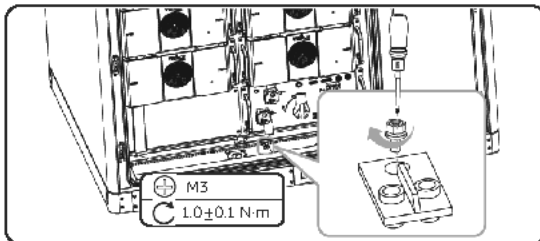

Figure 25-4 Installing the water sensor

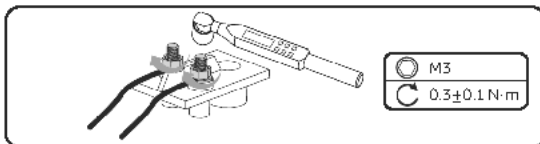

Figure 25-5 Connecting the cable

Checking after replacement

Use a multimeter to measure the water sensor ON-OFF status (OFF for normal, ON for abnormal).

26 Replacement of EPS Switch

Prerequisites

- Fault locating:
 - a. View alarm information via cabinet screen, EMS1000 webpage or SolaXCloud App.
 - b. Refer to the alarm handling suggestions in the alarm details.
 - c. Contact SolaX and order replacement parts.
- Tools: Cross screwdriver.



WARNING!

- Before replacing the EPS switch, ensure that the system is powered off. Otherwise, electric shocks may occur.
- After the system powers off, there will still be the remaining electricity and heat which may cause electric shocks and body burns. Please wear personal protective equipment (PPE) and begin servicing the system 15 minutes after power off.
- Only qualified person can perform the maintenance for the device.

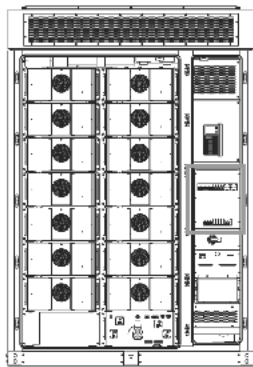

Figure 26-1 Position of the EPS switch

Procedure

Step 1: Unscrew the M4 screws on the front panel of the distribution box and remove the panel.

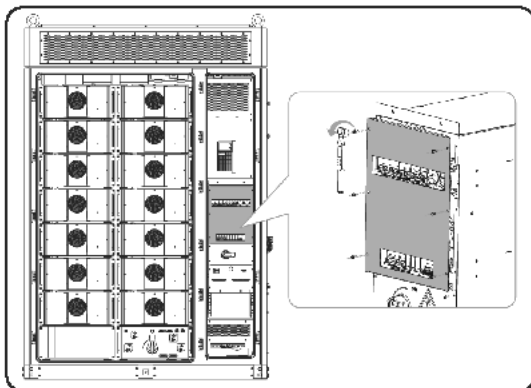

Figure 26-2 Removing the front panel

Step 2: Remove cables of the EPS switch

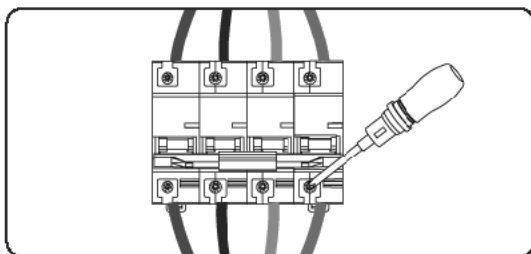

Figure 26-3 Removing the front panel

Step 3: Remove the EPS switch.

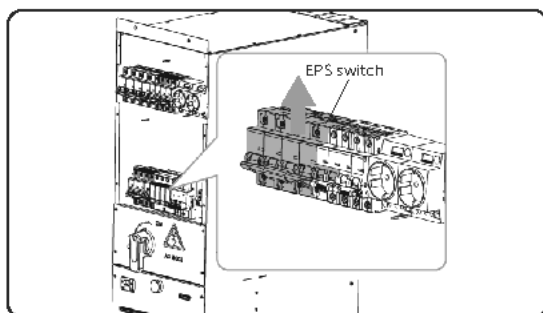

Figure 26-4 Removing the EPS switch

Step 4: Install a new EPS switch and connect the cables according to the cable labels.

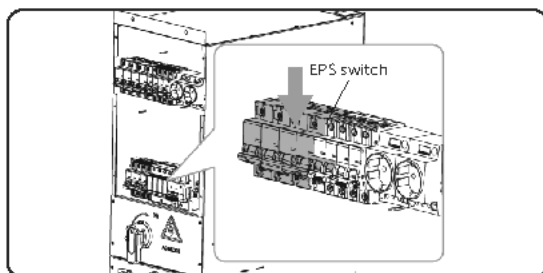

Figure 26-5 Installing the EPS switch

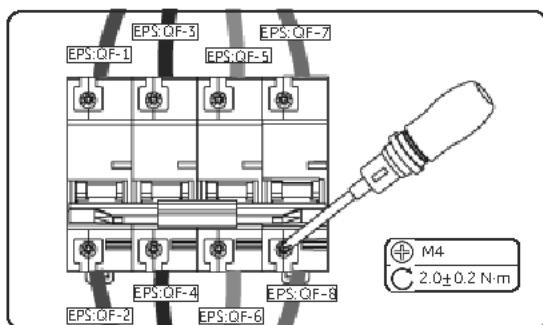

Figure 26-6 Connecting EPS switch cables

Step 5: Install the panel.

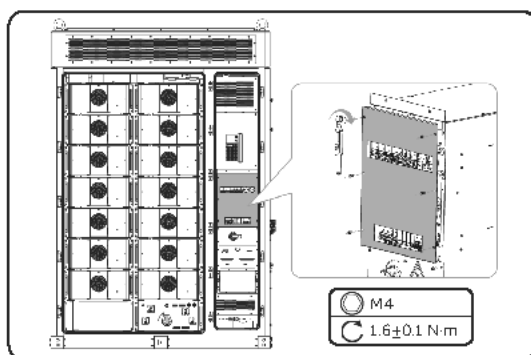

Figure 26-7 Mounting the panel

Checking after replacement

Check whether the EPS switch can be switched on and off normally.

27 Replacement of UPS Switch

Prerequisites

- Fault locating:
 - a. View alarm information via cabinet screen, EMS1000 webpage or SolaXCloud App.
 - b. Refer to the alarm handling suggestions in the alarm details.
 - c. Contact SolaX and order replacement parts.
- Tools: Cross screwdriver.



WARNING!

- Before replacing the UPS switch, ensure that the system is powered off. Otherwise, electric shocks may occur.
- After the system powers off, there will still be the remaining electricity and heat which may cause electric shocks and body burns. Please wear personal protective equipment (PPE) and begin servicing the system 15 minutes after power off.
- Only qualified person can perform the maintenance for the device.

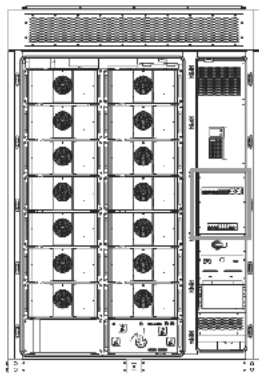

Figure 27-1 Position of UPS switch

Procedure

Step 1: Unscrew the M4 screws on the front panel of the distribution box and remove the panel.

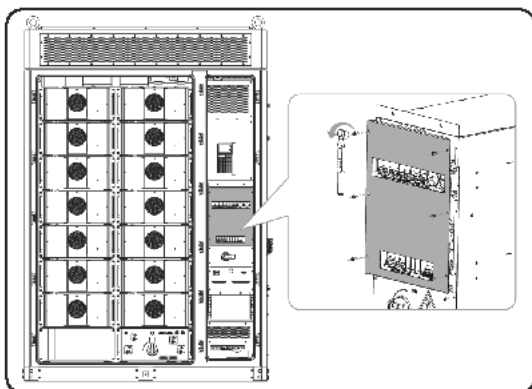

Figure 27-2 Removing the front panel

Step 2: Remove cables of the UPS switch

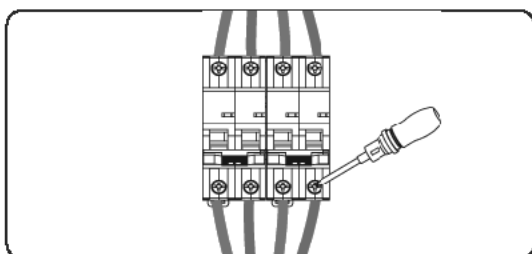

Figure 27-3 Removing the front panel

Step 3: Remove the UPS switch.

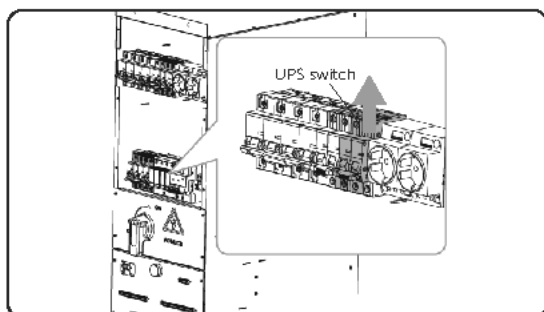

Figure 27-4 Removing the UPS switch

Step 4: Install a new UPS switch and connect the cables according to the cable labels.

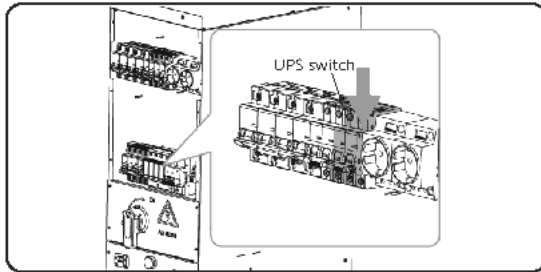

Figure 27-5 Installing the UPS switch

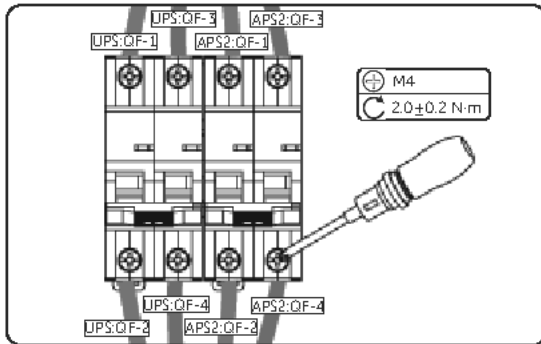

Figure 27-6 Connecting UPS switch cables

Step 5: Install the panel.

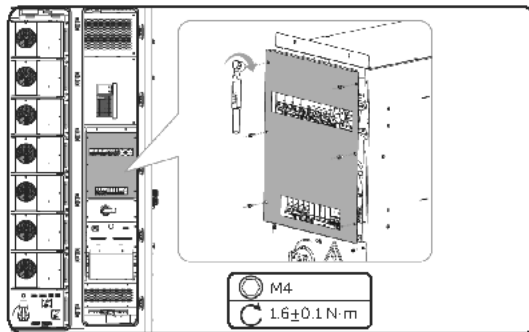

Figure 27-7 Mounting the panel

Checking after replacement

Check whether the UPS switch can be switched on and off normally.

28 Replacement of Inverter Fans

Prerequisites

- Fault locating:
 - a. View alarm information via cabinet screen, EMS1000 webpage or SolaXCloud App.
 - b. Refer to the alarm handling suggestions in the alarm details.
 - c. Contact SolaX and order replacement parts.
- Tools: Cross screwdriver, diagonal plier.

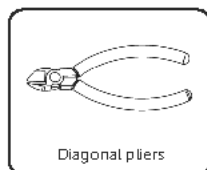
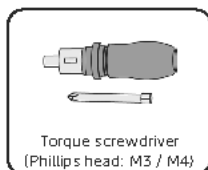

WARNING!

- Before replacing the fan, ensure that the system is powered off. Otherwise, electric shocks may occur.
- After the system powers off, there will still be the remaining electricity and heat which may cause electric shocks and body burns. Please wear personal protective equipment (PPE) and begin servicing the system 15 minutes after power off.
- Only qualified person can perform the maintenance for the device.

Procedure

Step 1: Loosen the M4 screws on the right side of the inverter with a cross screwdriver, and the nuts on the left side of the inverter.

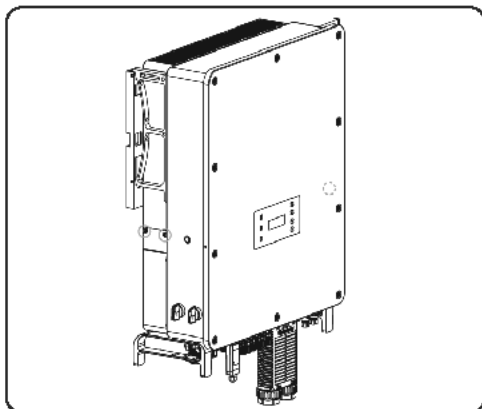

Figure 28-1 Dismantling screws

Step 2: Pull out the fan bracket, stop at the position about 150 mm, then press the protruding block with a screwdriver to release the fan waterproof connectors, then pull the fan bracket again to pull out the whole bracket.

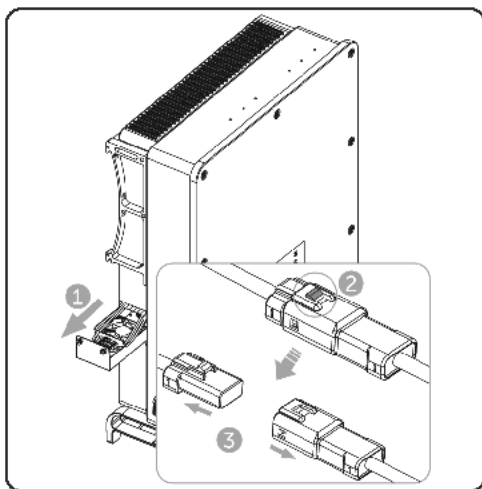

Figure 28-2 Releasing the fan waterproof connectors

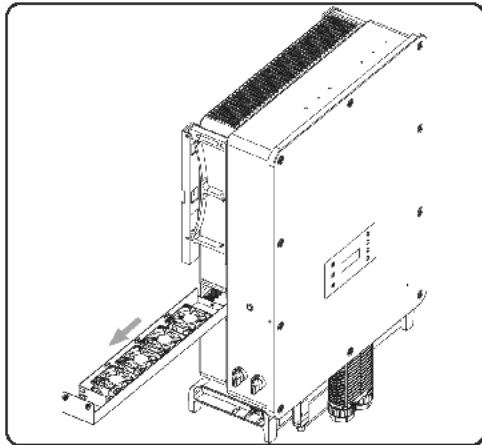

Figure 28-3 Pulling put the whole fan bracket

Step 3: Clean, repair, or replace the fan.

- a. Identify the fan to be replaced by cable markings.

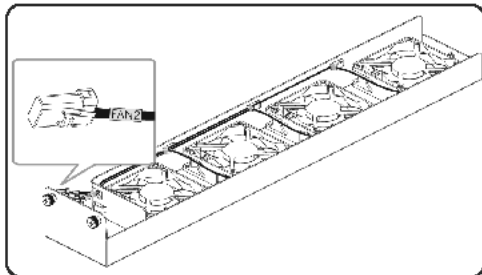

Figure 28-4 Identify the fan to be replaced

- b. Cut the cable ties with diagonal plier.

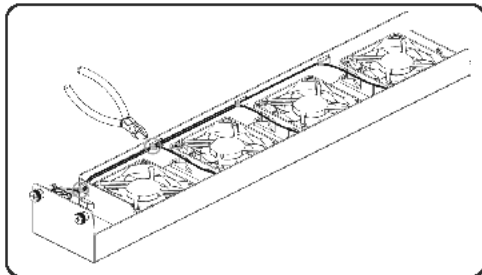

Figure 28-5 Cut the cable ties

- c. Unscrew the M3 screws on the bottom of the bracket.

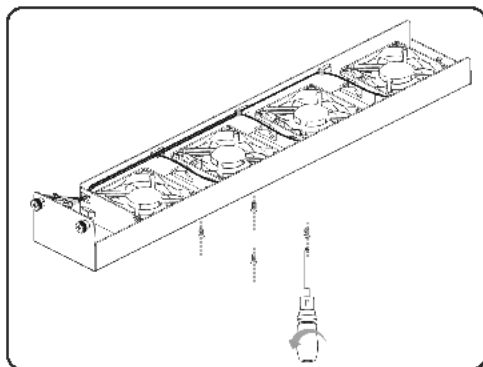

Figure 28-6 Unscrew the fan screws

- d. Remove the damaged fan, replace a new fan.

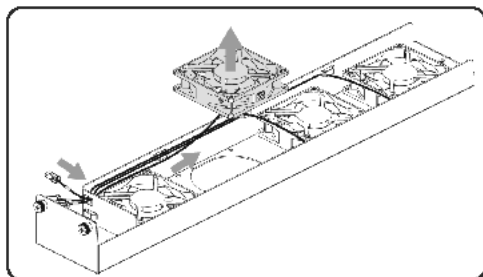

Figure 28-7 Remove the damaged fan

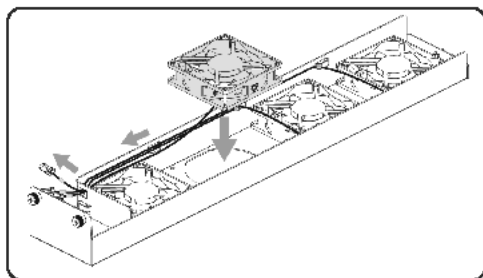

Figure 28-8 Replace a new fan

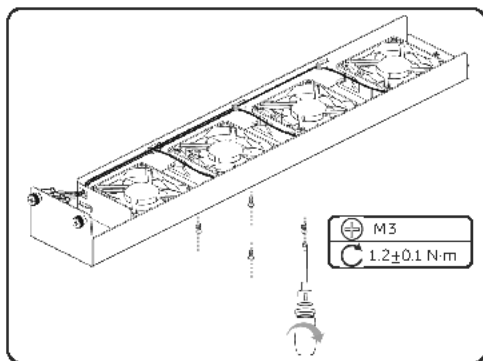

Figure 28-9 Lock the screws

- e. Secure the cable with the cable ties.

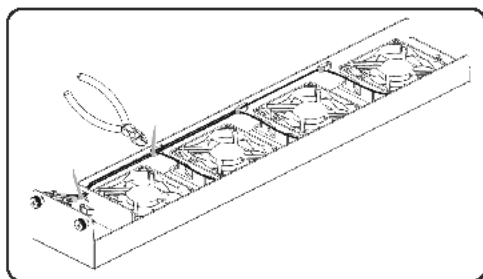

Figure 28-10 Unscrew the fan screws

- f. Slide the fan bracket into the inverter, connect fan waterproof connectors.

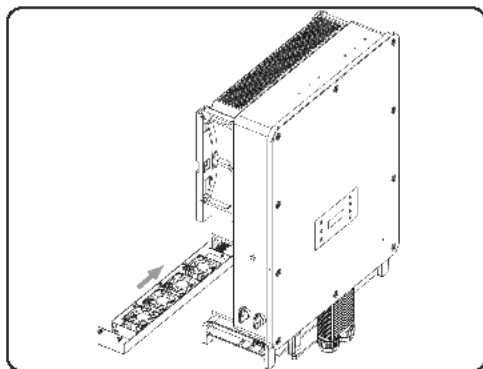

Figure 28-11 Slide the fan bracket

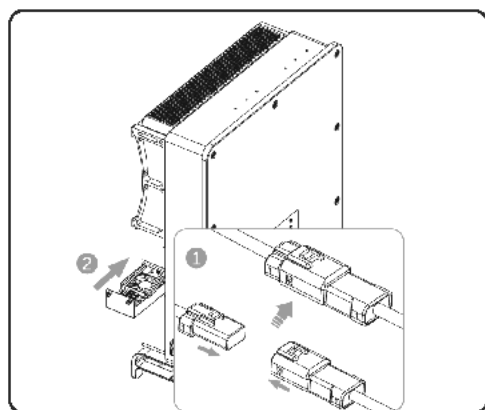

Figure 28-12 Connect fan waterproof connectors

Step 4: Lock the fixing screws.

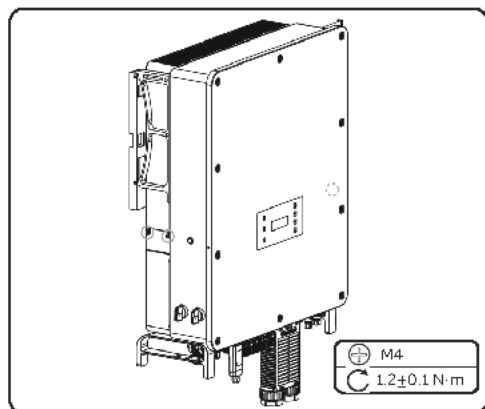

Figure 28-13 Lock the screws

Checking after replacement

For details of checking procedure after replacement, please refer to "30 Checking after Replacement".

29 Replacement of Inverter

Prerequisites

- Fault locating:
 - a. View alarm information via cabinet screen, EMS1000 webpage or SolaXCloud App.
 - b. Refer to the alarm handling suggestions in the alarm details.
 - c. Contact SolaX and order replacement parts.
- Tools: Removal tool for PV connectors, cross screwdriver, torque wrench, crane.

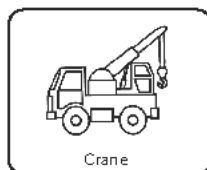
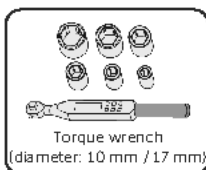
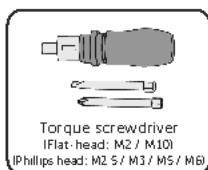
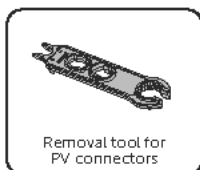

WARNING!

- Before replacing the inverter, ensure that the system is powered off. Otherwise, electric shocks may occur.
- After the system powers off, there will still be the remaining electricity and heat which may cause electric shocks and body burns. Please wear personal protective equipment (PPE) and begin servicing the system 15 minutes after power off.
- Only qualified person can perform the maintenance for the device.

NOTICE!

- The replaced devices should be sent back to the local SolaX warehouse.

Procedure

Please refer to *AELIO-P50B200 and AELIO-P60B200 User Manual* for inverter replace procedures.

Checking after replacement

- Step 1:** Power on the system. For details, refer to "2.4 Power On".
- Step 2:** Check whether the inverter LCD lights up and ensure the functions are restored.

30 Checking after Replacement



- Step 1:** Check that the replacement parts are installed and connected correctly and securely.
- Step 2:** Check the cable jacket for damage, especially the cable jacket connecting with the metal parts.
- Step 3:** Power on the system. For details, refer to "2.4 Power On".
- Step 4:** Check the running status of the system and ensure that the functions are restored.
- Step 5:** Check whether the alarm status is displayed as resolved and no new alarms are generated via the cabinet screen, EMS1000 webpage or SolaXCloud App.

Contact Information

UNITED KINGDOM

 Unit C-D Riversdale House, Riversdale
Road, Atherstone, CV9 1FA
 +44 (0) 2476 586 998
 service.uk@solaxpower.com



TURKEY

 Fevzi Çakmak mah. aslım cd. no 88 A
Karatay / Konya / Türkiye
 service.tr@solaxpower.com



USA

 3780 Kilroy Airport Way, Suite 200, Long
Beach, CA, US 90806
 +1 (408) 690 9464
 info@solaxpower.com

POLAND

 WARSAW AL. JANA P. II 27. POST
 +48 662 430 292
 service.pl@solaxpower.com

ITALY

 +39 011 19800998
 support@solaxpower.it

PAKISTAN

 service.pk@solaxpower.com





AUSTRALIA

 21 Nicholas Dr, Dandenong South VIC 3175
 +61 1300 476 529
 service@solaxpower.com.au



GERMANY

 Am Tullnaupark 8, 90402 Nürnberg,
Germany
 +49 (0) 6142 4091 664
 service.eu@solaxpower.com
 service.dach@solaxpower.com



NETHERLANDS

 Twekkeler-Es 15 7547 ST Enschede
 +31 (0) 8527 37932
 service.eu@solaxpower.com
 service.bnl@solaxpower.com

SPAIN

 +34 9373 79607
 tecnico@solaxpower.com

BRAZIL

 +55 (34) 9667 0319
 info@solaxpower.com

SOUTH AFRICA

 service.za@solaxpower.com



SolaX Power Network Technology (Zhejiang) Co., Ltd.

Add.: No. 278, Shizhu Road, Chengnan Sub-district, Tonglu County,
Hangzhou, Zhejiang, China
E-mail: info@solaxpower.com

